



PRODUCT OVERVIEW
2020-2021

**THIRD
EDITION**



HELLA Automotive Sales, Inc.

www.hellausa.com
www.myhellalights.com



HELLA: AN EXPERT PARTNER TO THE AFTERMARKET AND GARAGES

In the aftermarket the brand name of HELLA stands for a wide and attractive range of products, for professional workshop equipment and for first-class service, all from a single source. These three core competencies together form the HELLA Parts, Tools and Services concept.

PARTS

Our unbeatable range of parts provides excellent market coverage with top-flight quality, comprises approximately 38,000 articles for wholesalers of car parts and for independent garages. The range covers spare parts and universal parts for the following areas: lighting, brakes, electrics, electronics and thermal management.

SERVICES

Our extensive selection of advantages and backup (Services) rounds off this service spectrum with technical customer service and attractive sales support, with garage concepts and with professional logistics.



IMPORTANT: CATALOG PART NUMBERS

Dear customers,

In this catalog edition you will find "Catalog Part Number" indicated inside a parenthesis in the right side and "HELLA Internal Part Number", text indicated in bold font. The two different part numbers apply for the same product.

Your HELLA Team

"CATALOG PART NUMBER"

(H27117001)



K-LED 40 NEW	<ul style="list-style-type: none"> Perfect LED light (LED beam) (H4, H4R, H4S, H4C) High and compact low beam output Available as permanent beam mount or temporarily changed mount 3 year warranty 	<ul style="list-style-type: none"> Flash Pattern: 5, 4 and 5-4-4-4-4-4-4-4-4-4 Approved: SAE, JASO Class 2 Color: Amber Power Consumption: 21Watt Housing: Fixed, Magnet mount Connection: Fixed-mount, 1x 1" cable with open wire leads, Magnet: 30W compatible with lighter plug + switches 	358114701 (H27117001) Roadster
			358114711 (H27117011) Magnet

"HELLA Internal Part Number"
358114701



Our catalog gives you an overview and detail of the full range of products.

For more details and other applications, please see our websites:

www.hellausa.com
www.partcat.com/hella

CONTENT

Page

1. HELLA GROUP 4

2. LIGHTING 6

Auxiliary Lighting	8
Lighting Modules	25
Conversion Headlights	28
Specific Vehicle Lighting	32
Shapeline lighting	34
HELLA VALUEFIT Product Range	36
Worklights	56
Optical Warning Systems	64
HELLA MINING	76
HELLA MARINE	77
Bulbs	78
Bulb Product Range	80
Bulbs Summary	86
Halogen Bulbs	88
Miniature Bulbs	96
LED Miniature Bulbs	110
High Intensity Discharge (HID) Bulbs	112
Special Halogen Bulbs	114
Motorcycle Bulbs	126

3. WIPER BLADES 130

Standard Wiper Blades	132
Cleantech Wiper Blades	134
Rear Wiper Blades	136
Rear wiper blades for Specific Vehicles	138
Heavy Duty Wiper Blades	140
Related Products: Electric Water Pumps, Cleaning System Headlights, Tanks, relays	142

4. ELECTRICS 144

Horns, Disc Horns and Trumpets	146
Backup alarms and displays	160
Relays	164
Flashers	174
Electrical Accessories: Bases, Fuse boxes	175
Fuses, fuse holders	178

5. ELECTRONICS 182

Electronics Product Overview	184
Highlighted Products	186

6. HELLA PAGID BRAKE SYSTEMS 190

7. DIGITAL SERVICES 194

HELLA TECH WORLD	196
------------------	-----

8. TECHNICAL INFORMATION 198

HELLA GROUP FACTS

40,000

Employees world wide

7,000

People working in
research and development



125+

Locations world wide

40

Best automotive parts suppliers in the world



FREEDOM IS WHAT YOU DO!

HELLA auxiliary lamps can cope with all expeditions and adventures, regardless of how rugged the terrain is and the extreme weather.



ADDLIGHT - Discover how your HELLA auxiliary lamps will look in your car, in detail and interactively! Available in Apple Store and Google Play

www.hella.com/apps

AUXILIARY LIGHTING

When it comes to accessories, HELLA is always the right partner. For many years, our lighting experience has been reflected in the most varied innovations. With our wide range of auxiliary lamps, reversing lights, work lights, daytime running lights and interior lights, as well as side marker lights and interior lighting, we are one of the leading suppliers in the market. As the use of LED technology increases, HELLA strives to be at the forefront of new ideas and technologies.

More light? Of course! Should we turn night into day for you, or do you want to see the road clearly in front of you, even when the weather is bad? Our auxiliary lights stand out for their legendary performance and quality, and for the spotlights that continue to improve we offer greater safety, lighting your way ideally, whether by fog lights, long, short and wide-range spotlights.



ELIVER - Online comparison tool for light distribution



www.hella.com/eliver

NEW! HELLA VALUEFIT 450 LED AND 500 LED



HELLA VALUEFIT: Proven quality at an excellent price

HELLA VALUEFIT is a specific range of auxiliary lighting fixtures, designed exclusively to meet customer requirements. HELLA VALUEFIT products offer reliable quality at a fair price. In addition, HELLA has combined decades of technological knowledge with a unique business experience. As a result, all lighting fixtures meet the relevant technical specifications, are safe, reliable and easy to install.

In addition, there is no need to dispense with important services. HELLA VALUEFIT products offer genuine added value and proven quality at an excellent price!

Microsite - Meet the HELLA and HELLA VALUEFIT lighting product range



www.myhellalights.com

KNOWLEDGE OF LIGHT AND POWER

Innovations from HELLA. With HELLA, you opt for products with uncompromising quality. We work every day to make our lighting solutions even better and safer. As a result of our relentless innovative energy, we are among the first, best and even the sole suppliers or manufacturers in many areas of vehicle and lighting technology. We are currently pleased to be playing a particularly strong pioneering role with our Rallye LED using 100% LED technology.

Research and development. As in the field of stress testing where we test our products on the durability of the material and light source, HELLA lamps undergo continuous quality and performance tests for light distribution and radiation intensity. They are granted approval under the type approval requirements of the EU approval process. Different tasks require different lamps. The result is lamps of the highest quality – perfectly matched to the most diverse requirements under extreme conditions.

RADIATION INTENSITY



LIGHT DISTRIBUTION SHOULD BE CONSIDERED OBJECTIVELY.

Different applications require different auxiliary lights. The Isolux diagrams show a comparison of light distributions. The red-orange colouring marks the area with high illumination intensity. From yellow through green to blue, the illumination intensity decreases depending on distance. Fog light radiation is wide but not over a long distance (to avoid, as far as possible, reflection through fog droplets).

THE LUX UNIT

As a unit of illuminance, Lux defines the luminous flux from a light source that hits a specified surface. For example, an office should be illuminated with at least 500 Lux and with just 1 Lux the human eye

can read a newspaper without any problem. The values along the Lux bar show where the respective illuminance is achieved in the light distribution diagrams.

THE HIGH-BOOST REFLECTOR

High-boost reflectors are specially developed by HELLA to provide maximum light output. Compared to standard commercial auxiliary lights of similar size, HELLA auxiliary lights with high-boost reflectors deliver a much higher degree of efficiency with improved light output.

THE "REF." REFERENCE NUMBER

The reference number is a value applicable to spotlights. According to the ECE Regulation in effect since 2009, the sum of the reference numbers of all the installed

lamps must not exceed the upper limit of 100 per vehicle. The two values of the standard high beam (left and right main lamps) plus the values of any other extra spotlights are added together. The reference number of HELLA spotlights as well as the E-type approval mark can be found in the catalog for each model. A high beam with a 17.5 reference number emits a wide and full beam, but not as much as a high beam with a 37.5 reference number. A high beam Ref. 37.5 is therefore ideal for long, straight distances, while a high beam Ref. 17.5 can illuminate curved routes (especially mountainous areas) better.

Note: In some countries, a maximum high beam power of only 75 (reference value) may be connected. In those countries, the

high beam integrated into the vehicle must be inoperative when using the Ref. 37.5 high beam; however, the Ref. 17.5 high beam can generally be connected in addition.

CELIS® light guides

With CELIS® technology (Central Lighting Systems), fibreglass cables or thin plastic rods transport the light from a central light source to where it is required.

ECE & SAE APPROVALS

ECE Approval: The World Forum of Vehicle Regulations is a working party of the United Nations Economic Commission of Europe (ECE). It is tasked with creating a uniform set of regulations for vehicles, which makes them legal on the streets of participating countries.

SAE Approval: The USA has its own set of standards, which are called the Federal Motor Vehicle Safety Standards (FMVSS), which are based on proposals of the Society of Automotive Engineers (SAE). The USA does not recognize ECE approvals. Canada has its own Canada Motor Vehicle Safety Standards (CMVSS), broadly similar to FMVSS, but Canada does also accept ECE-compliant headlamps

AUXILIARY LIGHTING

Illumination and Isolux diagrams

Using Isolux diagrams, we can illustrate and compare light distributions. The red-orange colour indicates the area of high intensity illumination; the illuminance falls from yellow to green to blue depending on the distance from the light source.

Rallye 4000 LED
with Ref. 40

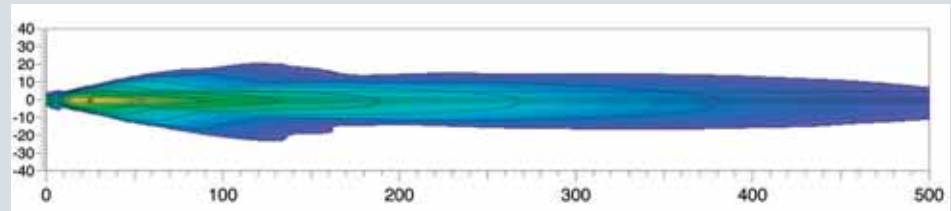

Rallye 40000i Xenon
with Ref. 37.5

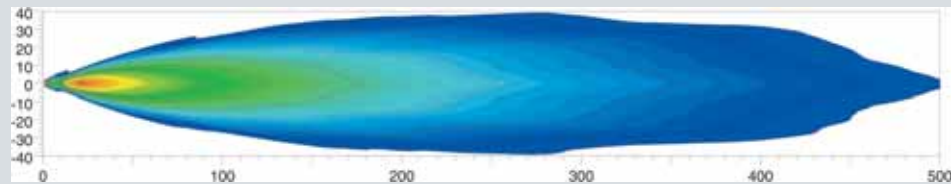

Rallye 4000 Halogen
with Ref. 17.5

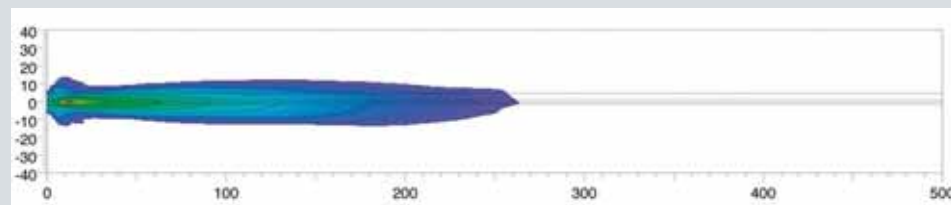

FOG LAMP

Fog lamp HELLA 500
with Ref. 12.5

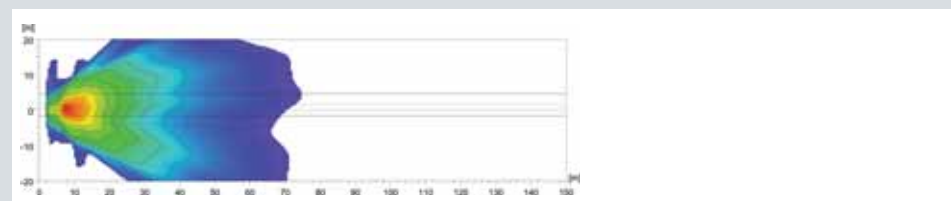

HELLA LED LIGHT BAR SERIES



The Choice of the Professional Driver

Then look no further: HELLA has just the right equipment for professional and recreational drivers, introducing a range of award winning LED light bars that guarantee powerful illumination for ultra-durable applications: Meet the LED Light Bar 350 and its bigger brother, the LED Light Bar 470.

As a manufacturer of world leading state of the art light technology, HELLA's relentless dedication to continuously improve the latest designs is shown in the unique range of LED Light Bars that stand out due to their light weight, a revolutionary non corrosive housing and a flexible mounting system for numerous applications.



LED Light Bar 350
SEMA Global Media
Awards Winner 2016



LED Light Bar 470

01 Outstanding Thermal Performance

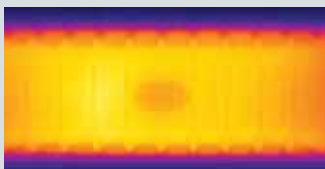

Revolutionary plastic ceramic materials, with outstanding thermal performance, open up a world of possibilities that was never thought to be achievable only a few years ago. The replacement of metal based housing heat-sinks with thermally conductive plastic not only opens a myriad of design options, but also means complete corrosion resistance. This is especially important in demanding environmental conditions where lights are constantly exposed to the elements and are sometimes temporarily submerged.



A lamp housing made from thermally conductive plastic works much the same as the previously used metal housing. The innovative ceramic based plastic transfers the heat generated by the LED's and drive electronics to the outside of the lamp body, thereby lowering the internal thermal stress on the component. This in turn ensures a long service life with minimal degradation of the LED's.

02 Intelligent Design Features

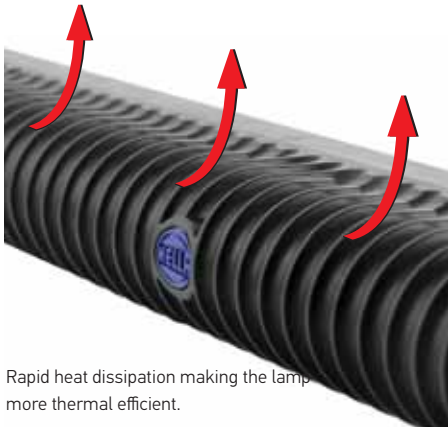

Rapid heat dissipation making the lamp more thermal efficient.

Expertly designed and precision manufactured for the toughest of outdoor conditions.

The LED Light Bar housing has been purposely designed with a wavy contour to optimize rapid heat dissipation, making the lamp more thermal efficient.

Off-roading can be a dirty business, the wavy contour is easy to clean as there are no cavities which can be clogged with dirt, unlike traditional light bars with a horizontal fin design.



Housing design incorporates an easy to clean profile.

03 Light Weight

Less metal also means less weight: Lamps with thermally conductive plastic are up to 60% lighter than comparable metal bodied lamps. The much lower mass significantly reduces the stress on mounting points in high vibration and shock applications.

When mounting the popular Driving Lights on ATV's and off-road vehicles, weight is an important factor. Compared to many heavier lights in the market, HELLA's Light Bars have little impact on the original vehicles all-important weight distribution.

Double bracket light bar for off-road use only



04 LEDs

Durable high performance automotive grade LEDs and precision optics give the light bar superior illumination on and off-road.



LED Light Bar 350 - 12 LEDs
LED Light Bar 470 - 16 LEDs



05 Dust and Waterproof

Built to stand all weather and off-road conditions the light bar is hermetically sealed making it dust and waterproof.

IP 6K7 (Protection against dust and temporary water immersion)

IP 6K9K (Protection against dust and highpressure/steam jet cleaning)

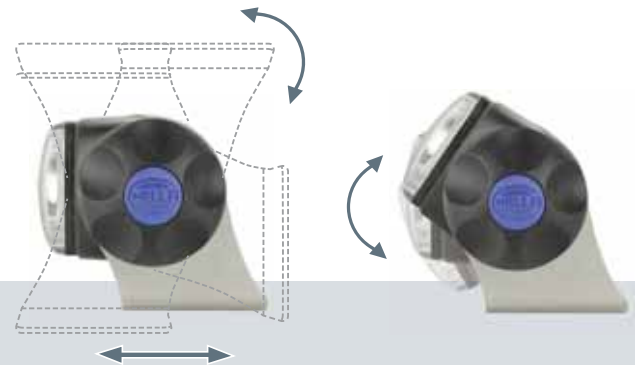

06 Low Profile Mounting System

The HELLA LED Light Bar has a much lower profile than traditional light bars, this allows more flexibility in where the lamp can be mounted. The aerodynamic design results in less disturbance to the air flow so that the vehicle's cooling and performance are not adversely affected if the lamp is mounted near a radiator grille.

The heavy duty bracket will suit most vehicle installations. Easy to mount and adjust and therefore ideal for numerous applications. Made of stainless steel, it is ultra durable and non corrosive.

HELLA LED LIGHT BAR 470

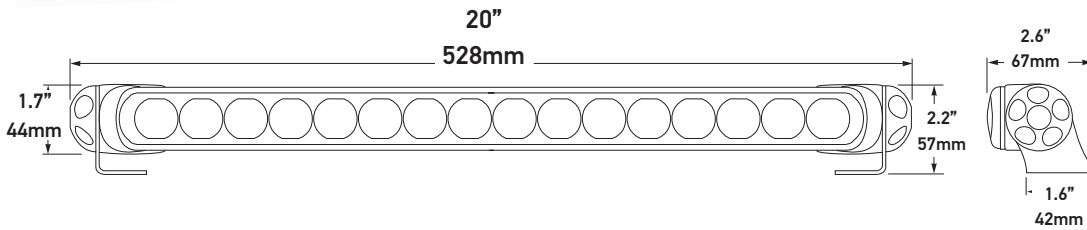

After the success of the HELLA LED Light Bar 350, HELLA is introducing the longer and brighter brother, the LED Light Bar 470. The new Light Bar features all the outstanding properties of the previous model plus an additional four high performance automotive LEDs and a maximum luminous intensity of 166,000 candela at a power consumption of only 35 watts. Weighing only 2lbs (950g) the Light Bar is particularly popular for roof mount applications on ATV's and Off-road vehicles.

Features:

- Lightweight at only 2lbs (950 g)
- 2800 measured lumens
- With 16 intensely bright high-power LEDs
- Reverse polarity and transient spike protection
- Connection: Wire leads
- 35 Watt, 9 - 33V (Multivolt)

Mounting:

- Horizontal mounting
- Pendant mounting

Applications:

- Long Range
- Off road use (Driving and Pencil beam versions ECE approved)
- Trucks / SUVs / ATVs / UTVs / Off-road vehicles

LIGHT DISTRIBUTION:

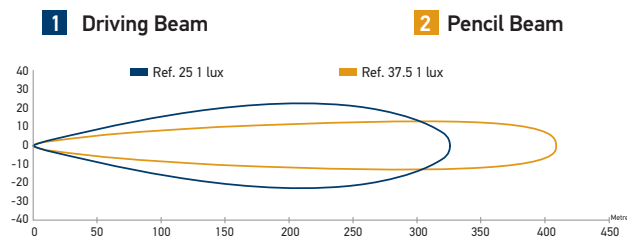

SPECIFICATIONS

Mounting	Upright or pendant.
Voltage	Multivolt™ for optimum brightness at input voltages from 9 to 33 volts.
Protection	Reverse polarity and transient spike protection. IP 6K7 (Protection against dust and temporary water immersion) IP 6K9K (Protection against dust and high-pressure/steam jet cleaning)
Cable Length	Pre-wired with 8ft (2.5m) of tinned multi-core cable.

CONTENTS

1 x LED Light Bar 470	2 x HD mounting brackets	1 x Mounting instructions
-----------------------	--------------------------	---------------------------



Part Number

LED light bar 470 - Driving Beam ECE approved	958130112
LED light bar 470 - Pencil Beam ECE approved	958130012

Accessories

Stainless Steel Dual Bracket compatible with 350 and 470 Light Bars	Part Number
Dual Bracket	958128811

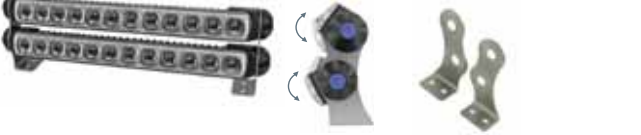

HELLA LED LIGHT BAR 350

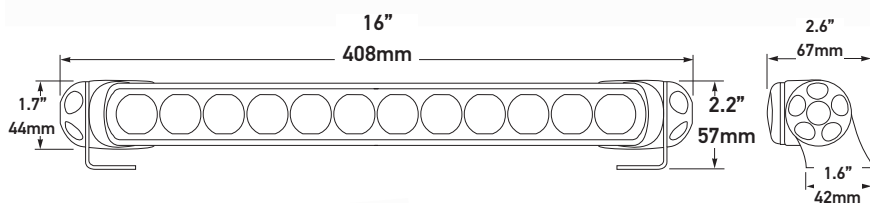

Features:

- Lightweight at only 1.7 lbs (790 g)
- Two intensity light settings for Wide and Narrow Beam versions
- 1500 Lumens for Driving and Pencil Beam versions
- 2200 Lumens for Wide and Narrow Beam versions (on 'High' setting)
- 220 Lumens for Wide and Narrow Beam versions (on 'Low' setting)
- With 12 intensely bright high-power LEDs
- Connection: Wire leads
- 25 Watt, 9 - 33V (Multivolt)

Mounting:

- Horizontal mounting
- Pendant mounting

Applications:

- Long Range
- Off road use (Driving and Pencil beam versions ECE approved and street legal in Canada)
- Trucks / SUVs / ATVs / UTVs / Off-road vehicles

LIGHT DISTRIBUTION:

- 1** Driving Beam
- 2** Pencil Beam
- 3** Wide Beam
- 4** Narrow Beam

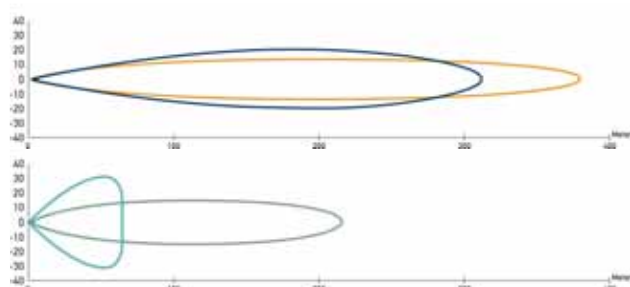

SPECIFICATIONS

Mounting	Upright or pendant.
Voltage	Multivolt™ for optimum brightness at input voltages from 9 to 33 volts.
Protection	Reverse polarity and transient spike protection. IP 6K7 (Protection against dust and temporary water immersion) IP 6K9K (Protection against dust and high-pressure/steam jet cleaning)
Cable Length	Pre-wired with 8ft (2.5m) of tinned multi-core cable.









CONTENTS

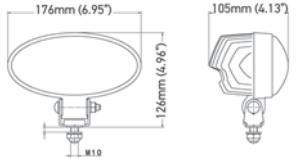
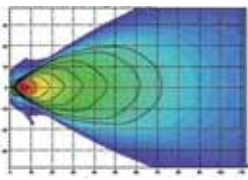

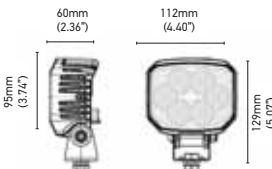
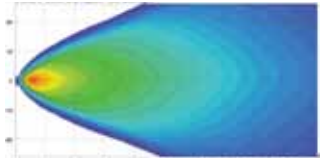
1 x LED Light Bar 350 2 x HD mounting brackets 1 x Mounting instructions

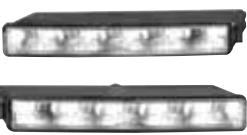
Part Number

LED light bar 350 - Driving Beam ECE approved	958040071
LED light bar 350 - Pencil Beam ECE approved	958040081
LED light bar 350 - Wide Beam with dimming function	958040521
LED light bar 350 - Narrow Beam with dimming function	958040641

AUXILIARY LIGHTING

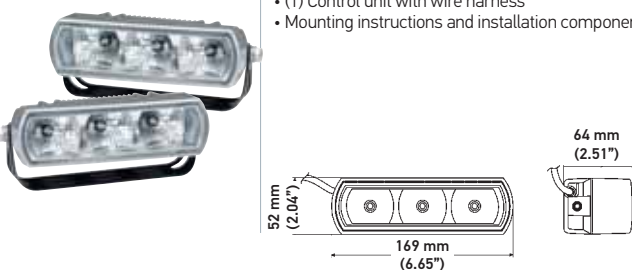
Product Image / Dimensions	Features	Technical specifications	Part Number
<p>FF300 LED</p> 	<p>LED</p> <ul style="list-style-type: none"> • 10 high performance LEDs • Low power consumption • Water and dust resistant • Protected against reverse polarity and over heating <p>Content:</p> <ul style="list-style-type: none"> • (1) LED headlight • Mounting instructions and installation components 	<ul style="list-style-type: none"> • Voltage: 9-33 VDC • Light output (measured): 2200 lumens • Light pattern: Driving beam • Power Consumption: 28 Watt • Color temperature: 6500 Kelvin • Housing material: Aluminum • Lens material: PMMA • Mounting: Stainless steel bracket • Mounting Type: Horizontal / Hanging • Connection: Wire leads 	<p>358116771 Single</p> 
<p>MICRO FF LED</p> 	<p>LED</p> <ul style="list-style-type: none"> • 6 high performance LEDs • Free form technology • Water and dust resistant • Protected against reverse polarity and over heating <p>Content:</p> <ul style="list-style-type: none"> • (1) LED headlight • Mounting instructions and installation components 	<ul style="list-style-type: none"> • Voltage: 9-33 VDC • Light output (measured): 1500 lumens • Light pattern: Driving beam • Power Consumption: 22 Watt • Color temperature: 6500 Kelvin • Housing material: Aluminum • Lens material: PMMA • Mounting: Stainless steel bracket • Mounting Type: Horizontal / Hanging • Connection: Wire leads (200 mm) with DT connector 	<p>358115981 Single</p> <p>Accessories:</p> <ul style="list-style-type: none"> • Wire harness (DT): H84985241 
<p>LEDAYLINE LED DAYTIME RUNNING LIGHTS</p> 	<p>LED</p> <ul style="list-style-type: none"> • 5 high performance LEDs • Attractive, transparent glass design that combines with any auxiliary headlights. • Aluminum housing • Compatible with SAE / DOT • Installation without problems through various options <p>Kit - Content:</p> <ul style="list-style-type: none"> • (2) LED headlights with brackets • (1) Control unit with wire harness • Mounting instructions and installation components 	<ul style="list-style-type: none"> • Voltage: 9-33 VDC • Light pattern: DRL position light • Power Consumption: 6 Watt • Color temperature: 6500 Kelvin • Housing material: PC • Lens material: Glass • Mounting Type: Flush • Connection: Wire harness with AMP connector • Approval: ECE / SAE 	<p>010043801 Kit</p>
<p>LEDAYLINE 15° Y 30° DAYTIME RUNNING LIGHTS</p> 	<p>LED</p> <ul style="list-style-type: none"> • 8 high performance LEDs (each) • Angled to fit the profile of the curved bumper • Hard UV resistant • Low energy consumption • Easy installation <p>Kit - Content:</p> <ul style="list-style-type: none"> • (2) lamps, (2) mounting brackets, (1) relay • Universal mounting hardware • Assembly instructions • (1) Control unit with wire harness • Mounting instructions and installation components 	<ul style="list-style-type: none"> • Voltage: 12 V • Light pattern: DRL position light • Power Consumption: 2 Watt • Color temperature: 6500 Kelvin • Housing material: PC • Lens material: PVC • Mounting Type: Flush • Connection: Wire harness with AMP connector • Approval: ECE / SAE 	<p>980850801 Kit - 30°</p> <p>980860801 Kit - 15°</p> 

Product Image / Dimensions	Features	Technical specifications	Part Number
<p>3 LED DAYTIME RUNNING LIGHTS</p> 	<p>LED</p> <ul style="list-style-type: none"> • 5 high performance LEDs • Attractive, transparent glass design that combines with any auxiliary headlight. • Installation without problems through various options <p>Kit - Content:</p> <ul style="list-style-type: none"> • (2) LED headlights with brackets • (1) Control unit with wire harness • Mounting instructions and installation components 	<ul style="list-style-type: none"> • Voltage: 9-33 VDC • Light pattern: DRL position light • Power Consumption: 5 Watt • Color temperature: 6500 Kelvin • Housing material: Aluminum • Lens material: Glass • Mounting Type: Vertical / Hanging • Connection: Wire harness with AMP connector • Approval: ECE / SAE 	<p>009496801 <small>Kit</small></p> 

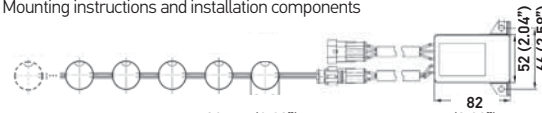
<p>LEDAY FLEX DAYTIME RUNNING LIGHTS</p> 	<p>LED</p> <ul style="list-style-type: none"> • LED daytime running lights set as position light • The set includes 2 modular chains with between 5 to 8 LED modules that can be configured in the vehicle front • Individual LED modules are circular and have a diameter of 1.1" (30 mm) • Each module has a high power LED • The metal housing safely protects the lighting and electronics against waste way and also for heat dissipation • Connection through a 3-pole AMP system 	<ul style="list-style-type: none"> • Voltage: 9-33 VDC • Light pattern: DRL position light • Power Consumption: 15 Watt per modular chain • Color temperature: 6500 Kelvin • Housing material: Magnesium • Lens material: Glass • Mounting Type: Flush • Connection: Wire harness with AMP connector • Approval: ECE / SAE <p>Kit - Content:</p> <ul style="list-style-type: none"> • 2 LED Module Strings • 2 control units with wire harness • Mounting instructions and installation components 	<p>010458731 <small>6 LEDs</small></p> 
--	--	---	--

RALLYE 4000LED

THE NEW AUXILIARY HEADLAMP WITH AN UNMISTAKABLE DESIGN

NEW!

- Auxiliary driving lamp with futuristic look boasting state-of-the-art LED technology
- The striking night design is created by the LED position light with its characteristic hexagonal contoured design
- EdgeLight technology has been applied for a more intensive appearance of the position light
- The horizontal cooling fin in the auxiliary head lamp with a cooling surface of 230 cm² brings about efficient thermal management
- Protection classes: IP X9K, IP 6K7

- Voltage: 12 / 24 VDC
- Light output (measured): 1300 lumens (Pencil beam), 1220 lumens (Flood beam)
- Light beam pattern: Pencil, Flood
- Power Consumption:
 - @ 12V: 2.4 W + high beam
 - @ 24V: 5 W + high beam
- Color temperature: 6500 Kelvin
- Housing material: Aluminum
- Lens material: PC
- Mounting: Zinc diecast
- Mounting Type: Horizontal
- Connection: Wire leads
- Approval: ECE R112 high beam, ECE R7 position light, ECE R10 EMC

Content:

- (1) LED headlight, assembly instructions
- Mounting instructions and installation components

Description	Part number	Spare parts*	Part number
Flood beam	016560101	Driving lamp insert,	241430011
Pencil beam	016560111	flood beam	
		Driving lamp insert,	241449011
		pencil beam	

* Usable for upgrading of Rallye 4000 Halogen driving lamps

Flood beam

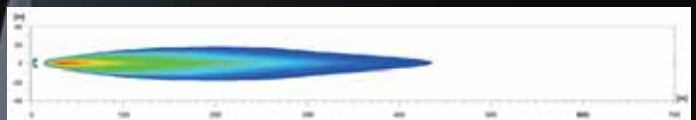









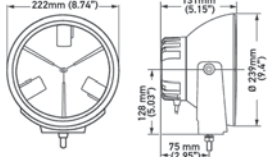
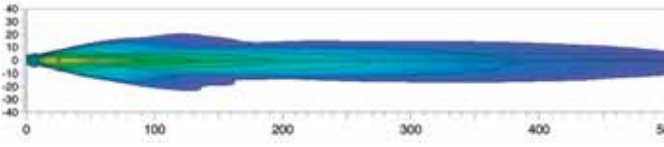

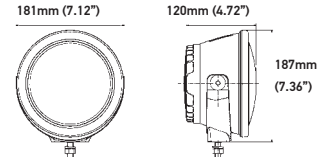
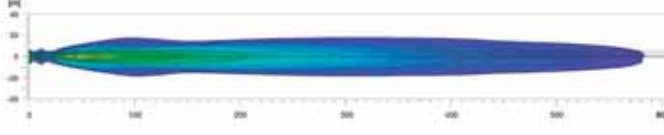

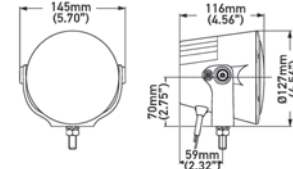
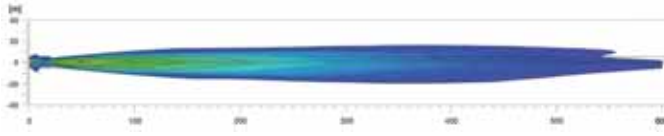

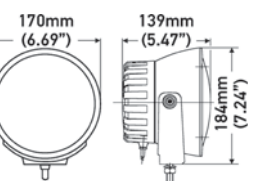
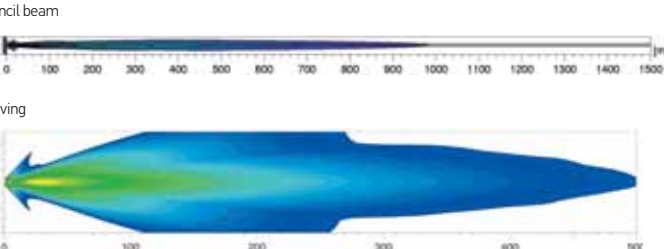
Pencil beam



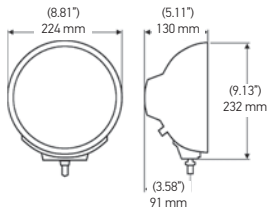
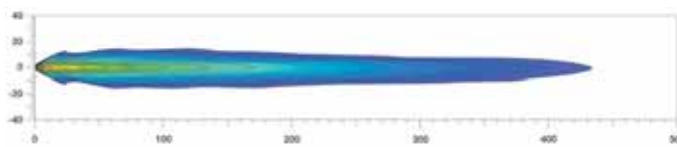

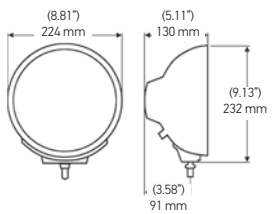
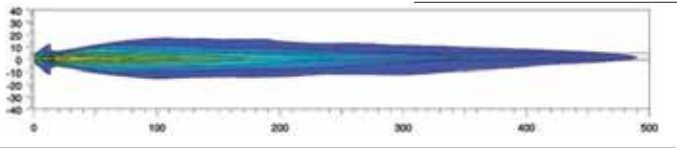

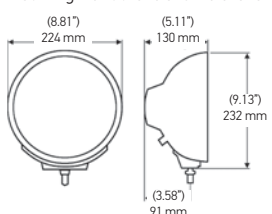
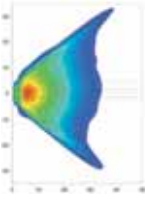

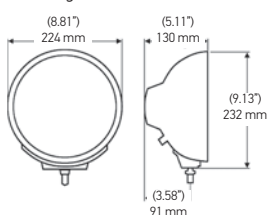
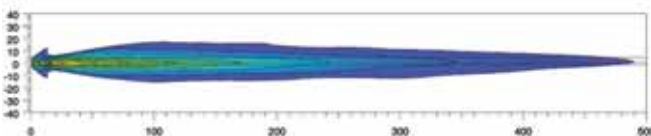
Metal

AUXILIARY LIGHTING

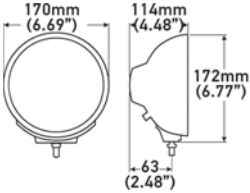
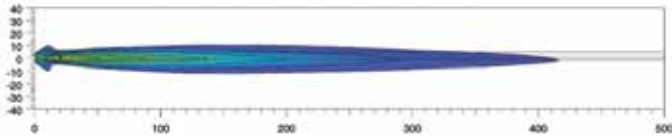
Product Image / Dimensions	Features	Technical specifications	Part Number
<p>RALLYE 4000 LED (REF. 40)</p> 	<p>LED</p> <ul style="list-style-type: none"> • 3 high performance LED modules • Metal housing with reflector with technology free form • Powder paint: matt black • Smooth lens with modern design • Low energy consumption - no need for light bulb exchange <p>Content:</p> <ul style="list-style-type: none"> • (1) LED headlight, assembly instructions 	<ul style="list-style-type: none"> • Voltage: 9-34 VDC • Light output (measured): 1500 lumens • Light beam pattern: Driving • Power Consumption: 30/1 Watt • Color temperature: 6000 Kelvin • Housing material: Aluminum • Lens material: PC • Mounting Type: Horizontal • Connection: Wire leads • Approval: ECE 	<p>011002221</p> <p>Replacement parts:</p> <ul style="list-style-type: none"> • Optical unit: 181541011 <p>Accessories:</p> <ul style="list-style-type: none"> • White cover: 147945011 • Cable harness: H84994031
<p>RALLYE 4000 COMPACT LED (REF. 45)</p> 	<p>LED</p> <ul style="list-style-type: none"> • 2 high performance LED modules • UV resistant polycarbonate lens • High quality metal housing • Double reflector for a light beam pattern uniform, which provides excellent road lighting • Low energy consumption • Water and dust resistant <p>Content:</p> <ul style="list-style-type: none"> • (1) LED headlight, (1) Protective cover assembly instructions 	<ul style="list-style-type: none"> • Voltage: 9-32 VDC • Light output (measured): 1500 lumens • Light pattern: Driving • Power Consumption: 11 Watt • Color temperature: 6000 Kelvin • Housing material: Aluminum • Lens material: PC • Mounting Type: Horizontal • Connection: 9.8 ft (3000mm) cable with open wires • Approval: ECE 	<p>011815041</p>
<p>RALLYE 4000X LED (REF. 37.5)</p> 	<p>LED</p> <ul style="list-style-type: none"> • 2 high performance LED modules • Dual reflector technology calculated by computer • High quality metal housing • Double reflector for a light beam pattern uniform that provides a excellent road lighting • Low energy consumption • Water and dust resistant <p>Content:</p> <ul style="list-style-type: none"> • (1) LED headlight, assembly instructions 	<ul style="list-style-type: none"> • Voltage: 10-32 VDC • Light output (measured): 1400 lumens • Light pattern: Driving • Power Consumption: 40 Watt • Color temperature: 6000 Kelvin • Housing material: Aluminum • Lens material: PC • Mounting Type: Horizontal • Connection: 9.8 ft (3000mm) cable with open wires • Approval: ECE 	<p>012206021</p>
<p>RALLYE 4000i COMPACT XENON (REF. 37.5)</p> 	<p>XENON</p> <ul style="list-style-type: none"> • Internal xenon reactance coil that facilitates the installation • Compact design • Powder paint: matt black • Smooth lens with modern design • Red ring <p>Content:</p> <ul style="list-style-type: none"> • (1) Headlight, (1) D1S xenon bulb • Reactance coil: Integrated - Generation 4 • Cables, relay and components for installation (protective cover not included) 	<ul style="list-style-type: none"> • Voltage: 12 VDC • Light source: D1S xenon bulb • Light pattern: Driving - Pencil beam • Power Consumption: 35 Watt • Housing material: Aluminum • Lens material: Glass • Mounting Type: Vertical / Driving • Connection: Wire leads • Approval: ECE - (N / A for Pencil beam) 	<p>009094331 Pencil beam</p> <p>009094321 Driving</p> <p>Replacement parts:</p> <ul style="list-style-type: none"> • Optical unit LA: 161825071 • Optical unit: 161825061 <p>Accessories:</p> <ul style="list-style-type: none"> • White cover: 165048011 • Cable harness: H84994031

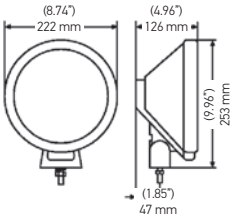
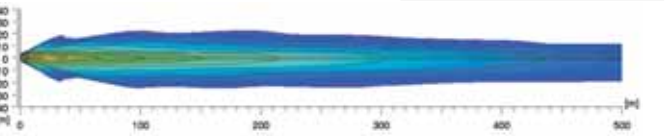
Product Image / Dimensions	Features	Technical specifications	Part Number
<p>RALLYE 4000 (REF. 37.5)</p> 	<p>HALOGEN</p> <ul style="list-style-type: none"> Tempered glass lens Cast zinc housing with matte black finish for the most extreme driving conditions Knurled buttons for quick adjustments of the light bulbs Change the appearance of any headlight with our protective covers Shieldz color <p>Content:</p> <ul style="list-style-type: none"> (1) headlight, (1) H1 12 V / 100 Watt bulb (1) Protective cover, (1) Connector Mounting instructions and installation components 	<ul style="list-style-type: none"> Voltage: 12 VDC Light source: H1 12 V / 100 Watt / T3-1 / 4 12 V / 5W Light pattern: Driving - Pencil - Curve light Driving with position light Power Consumption: 100 Watt Housing material: Zinc, Lens material: Glass Mounting type: Vertical Connection: Male connector, Approval: ECE (-031 only) <p>Color Shieldz Protective Foils:</p> <ul style="list-style-type: none"> Clear - H87988451, Yellow - H87988351 Blue - H87988341, Smoked - H87988361 	<p>007560931 Driving</p> <p>007560941 Driving + Position Light</p> <p>007560921 Light for curves</p> <p>007560951 Pencil beam</p> <p>Replacement parts:</p> <ul style="list-style-type: none"> White cover: 147945001 H1 12 V/100W bulb: H1 100W <p>Accessories:</p> <ul style="list-style-type: none"> Clear cover: H87988131 Protective grill: 148995001 Harness cables: 148541001
<p>RALLYE 4000 CHROME (REF. 37.5)</p> 	<p>HALOGEN</p> <ul style="list-style-type: none"> Glass lens with chromed metal housing high gloss Knurled knobs for quick adjustments of the light bulb Designed for driving conditions extreme <p>Content:</p> <ul style="list-style-type: none"> (1) Headlight, (1) H1 12V / 100W bulb + bulb for T3-1 / 4 12V / 5W (W5W) position light (1) Protective cover and Pigtail connector Mounting instructions and installation components 	<ul style="list-style-type: none"> Voltage: 12 VDC Light source: H1 12 V/100 Watt / T3-1 / 4 12 V/5W (W5W) Light pattern: Driving Power Consumption: 100 Watt Housing material: Zinc Lens material: Glass Mounting Type: Vertical Connection: Pigtail Connector Approval: ECE 	<p>007560911</p> <p>Replacement parts:</p> <ul style="list-style-type: none"> White cover: 147945001 H1 12 V/100W bulb: H1 100W T3-1/4 12 V/5W (W5W) Reflector Unit: 148131011 <p>Accessories:</p> <ul style="list-style-type: none"> White cover: H87988131 Protective grill: 148995001 Cable harness: 149147001 Harness 2 lamps: H84994031
<p>RALLYE 4000 FOG LIGHT</p> 	<p>HALOGEN</p> <ul style="list-style-type: none"> Tempered glass lens Cast zinc housing with matte black finish Knurled knobs for quick adjustments of the light bulb Designed for driving conditions more extreme <p>Content:</p> <ul style="list-style-type: none"> (1) Headlight, (1) H3 12V / 55W halogen bulb (1) Protective cover and Pigtail connector Mounting instructions and installation components 	<ul style="list-style-type: none"> Voltage: 12 VDC Light source: H3 12 V / 55W Light pattern: Fog Power Consumption: 55 Watt Housing material: Zinc Lens material: Glass Mounting Type: Vertical Connection: Pigtail Connector Approval: ECE / SAE 	<p>007560901</p> <p>Replacement parts:</p> <ul style="list-style-type: none"> White cover: 147945001 H3 12 V/55W bulb: H3 Reflector unit: 148131011 <p>Accessories:</p> <ul style="list-style-type: none"> Clear cover: H87988131 Protective grill: 148995001 Cable harness: 149147001 Harness 2 lamps: H84994031 <p>Color Shieldz Protective Foils:</p> <ul style="list-style-type: none"> Clear: H87988451 Blue: H87988351 Smoked: H87988361
<p>RALLYE 4000 FF (REF. 37.5)</p> 	<p>HALOGEN</p> <ul style="list-style-type: none"> Free form glass lens Cast zinc housing with matte black finish Knurled knobs for quick adjustments of the light bulb Designed for driving conditions more extreme <p>Content:</p> <ul style="list-style-type: none"> (1) Headlight, (1) H1 Bulb 12 V / 55 Watt + bulb for T3-1 / 4 12V / 5W (W5W) position light (1) Protective cover and Pigtail connector Mounting instructions and installation components 	<ul style="list-style-type: none"> Voltage: 12 VDC Light source: H1 12 V/55 Watt / T3-1/4 12 V / 5W (W5W) Light pattern: Driving Power Consumption: 55 Watt Housing material: Zinc Lens material: Glass Mounting Type: Vertical Connection: Male connector Approval: ECE 	<p>007560361</p> <p>Replacement parts:</p> <ul style="list-style-type: none"> White cover: 147945001 H1 12 V/55W bulb: H1 T3-1/4 12 V/5W (W5W) Reflector unit: 148131011 <p>Accessories:</p> <ul style="list-style-type: none"> Clear cover: H87988131 Protective grill: 148995001 Cable harness: 148541001

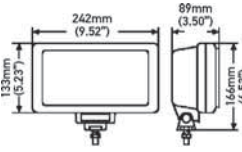
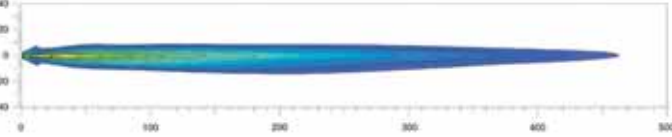
AUXILIARY LIGHTING

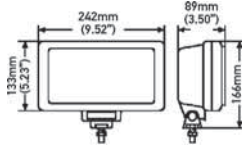
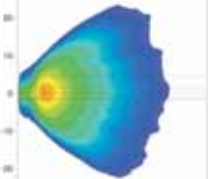
Product Image / Dimensions	Features	Technical specifications	Part Number
<p>RALLYE 4000 COMPACT (REF. 37.5)</p> 	<p>HALOGEN</p> <ul style="list-style-type: none"> Optimized free form reflector Transparent glass design 24% smaller than the Rally 4000 CELIS LED circular position light (009094191) <p>Content:</p> <ul style="list-style-type: none"> (1) Headlight, (1) H1 12 V / 55 Watt bulb (not included in -101) (1) Protective cover (not included in -101) Mounting instructions and installation components * Cable harness sold separately 	<ul style="list-style-type: none"> Voltage: 12 VDC Light source: H1 12 V / 55 Watt Light pattern: Driving - Long range Power Consumption: 55 Watt Housing material: Cast zinc housing with matte black finish Lens material: Glass Mounting Type: Vertical Connection: Wire leads Approval: ECE (-081 only) 	<p>009094101 Long range</p> <p>009094181 Driving</p> <p>Replacement parts:</p> <ul style="list-style-type: none"> White cover: 165048001 H1 12 V/55W bulb: H1 Reflector unit ECE: 161825031 Reflector unit ECE/SAE: 161825011 <p>Accessories:</p> <ul style="list-style-type: none"> Clear cover: H87988221 Cable harness: H84994031
<p>RALLYE 3000 BLUE (REF. 37.5)</p> 	<p>HALOGEN</p> <ul style="list-style-type: none"> Blue glass lens - the light beam looks white when it lights Optimized free form reflector Black ABS housing with silver ring with design blue stripes <p>Content:</p> <ul style="list-style-type: none"> (1) Headlight (1) Pigtail Connector Mounting instructions and installation components 	<ul style="list-style-type: none"> Voltage: 12 VDC Light pattern: Driving Light source: H1 12 V/55 Watt - T3-1/4 12 V/5W (W5W) Power Consumption: 55 Watt Housing material: ABS (housing) Lens material: Glass Mounting: Zinc coated steel bracket Mounting Type: Vertical Connection: Pigtail Approval: ECE 	<p>006800901</p> <p>Replacement parts:</p> <ul style="list-style-type: none"> T3-1/4 12V/5W 2825 Reflector unit ECE: 157042011 Pigtail: H84994061 <p>Accessories:</p> <ul style="list-style-type: none"> Bombillo H1 12/55W H1 White cover: 142700001 Cable harness: H84994031
<p>JUMBO 220 (REF. 37.5)</p> 	<p>HALOGEN</p> <ul style="list-style-type: none"> Classic design Black impact resistant housing and ring retention Glass lens Traditional design, the ideal complement to trucks and SUVs <p>Content:</p> <ul style="list-style-type: none"> (1) headlight, (1) H3 12 V / 55 Watt bulb (1) protective cover Mounting instructions and installation components 	<ul style="list-style-type: none"> Voltage: 12 VDC Light source: H3 12 V / 55 Watt Light pattern: Driving Power Consumption: 55 Watt Housing material: ABS (housing) Lens material: Glass Mounting: Zinc coated steel bracket Mounting Type: Vertical / Hanging Connection: Without cables Approval: ECE / SAE 	<p>006300921 Driving</p> <p>Replacement parts:</p> <ul style="list-style-type: none"> H3 12 V/55W bulb: H3 <p>Accessories:</p> <ul style="list-style-type: none"> White cover: 138127001 Cable harness: H84994031
<p>JUMBO 220 FOG LIGHT</p> 	<p>HALOGEN</p> <ul style="list-style-type: none"> Classic design for fog conditions Black impact resistant housing and ring retention Glass lens Traditional design, the ideal complement to trucks and SUVs <p>Content:</p> <ul style="list-style-type: none"> (1) headlight, (1) H3 12 V / 55 Watt bulb (1) protective cover Mounting instructions and installation components 	<ul style="list-style-type: none"> Voltage: 12 VDC Light source: H3 12 V / 55 Watt Light pattern: Fog Power Consumption: 55 Watt Housing material: ABS (housing) Lens material: Glass Mounting: Zinc coated steel bracket Mounting Type: Vertical / Hanging Connection: Without cables Approval: ECE / SAE 	<p>006300911</p> <p>Replacement parts:</p> <ul style="list-style-type: none"> H3 12 V/55W bulb: H3 <p>Accessories:</p> <ul style="list-style-type: none"> White cover: 138127001 Cable harness: H84994031

HELLA 500 SERIES



The art of lighting with an innovative reflector with free form technology

The HELLA 500, 500FF 700FF halogen auxiliary lamp series can easily be installed on the roof or on the front apron of the vehicles. They are perfectly equipped to withstand extreme driving situations. That not only sounds good, it also looks good: Compact design and black housing with matte finish.







In terms of lighting technology, these auxiliary lamps offer the following features a classic 500 and 700 series lamp design: A homogeneous illumination that, with the help of the computer-optimized free-form reflector, provides excellent visibility and active safety in extreme weather and driving conditions.



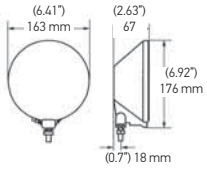
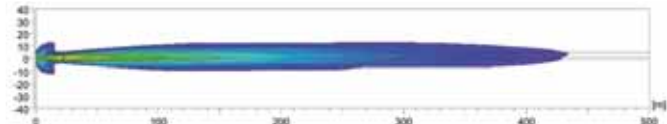

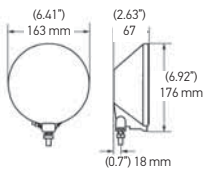
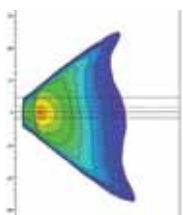

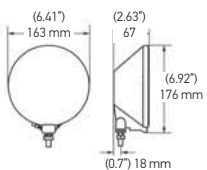
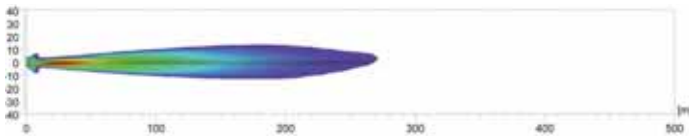
All HELLA 500, 500FF and 700FF series auxiliary lamps include:

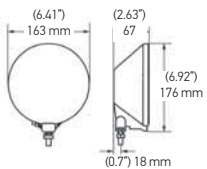
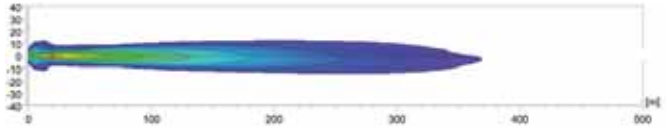
- 2 Halogen driving lights
- 2 Bulbs of 12 V / 55 Watt.
- 2 protective covers.
- 1 Relay 12 V, 1 Switch
- Wire harness, mounting brackets and assembly instructions.

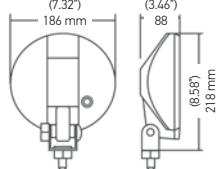

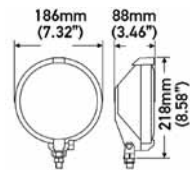

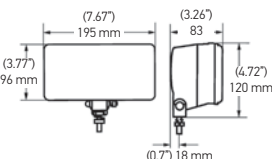

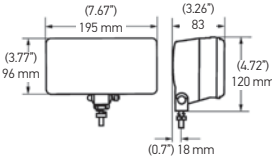
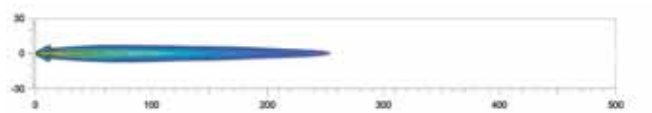



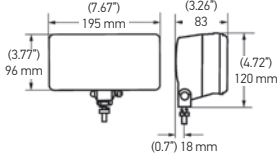
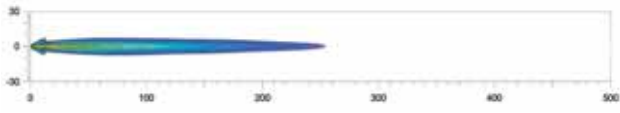



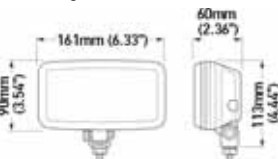
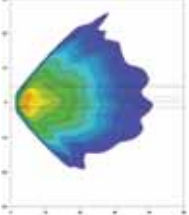

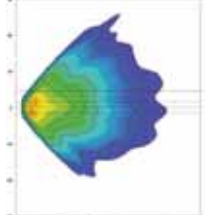

AUXILIARY LIGHTING

Product Image / Dimensions	Features	Technical specifications	Part Number
HELLA 500 (REF. 37.5) 	HALOGEN <ul style="list-style-type: none"> Lightweight design Impact resistant ABS housing Aluminum vapor coated reflector Glass lens <p>Single - Content:</p> <ul style="list-style-type: none"> (1) Headlight, (1) H3 12 V / 55 Watt bulb (1) protective cover Mounting instructions and installation components <p>Kit - Content:</p> <ul style="list-style-type: none"> (2) Headlights, (2) H3 12V / 55W bulbs, (1) wire harness (2) Protective covers, (1) switch, (1) relay Mounting instructions and installation material 	<ul style="list-style-type: none"> Voltage: 12 VDC Light source: H3 12 V / 55 Watt Light pattern: Driving Power Consumption: 55 Watt Housing material: ABS (housing) Lens material: Glass Mounting: Zinc coated steel bracket Mounting Type: Vertical / Hanging Connection: Wire leads Approval: ECE <p>Change the appearance of any headlight in the series HELLA 500 with Shield protective films available in: yellow, smoky and blue tones</p> 	005750411 Single 005750952 Kit 005750512 Single - amber Replacement parts: <ul style="list-style-type: none"> H3 12/55W bulb: H3 Relay 12 V/15A: 003530001 LED switch (green): H61923001 Accessories: <ul style="list-style-type: none"> White cover: 135236021 Black cover: H73146011 Clear cover: H87988081 Protective grill: 165530801 Cable harness: H84994031
HELLA 500 FOG LIGHT (REF. 12.5) 	HALOGEN <ul style="list-style-type: none"> Lightweight design Impact resistant ABS housing Aluminum vapor coated reflector Change the appearance of any headlight in the HELLA 500 with Shield protective films available in yellow, smoky, or blue tones Glass lens <p>Kit - contains:</p> <ul style="list-style-type: none"> (2) Headlights, (2) H3 12V / 55W bulbs, (1) wire harness (2) Protective covers, (1) switch, (1) relay Mounting instructions and installation material 	<ul style="list-style-type: none"> Voltage: 12 VDC Light source: H3 12 V / 55 Watt Light pattern: Fog Power Consumption: 55 Watt Housing material: ABS (housing) Lens material: Glass Mounting: Zinc coated steel brake Mounting Type: Vertical Connection: Wire leads Approval: ECE / SAE 	005750971 Kit Replacement parts: <ul style="list-style-type: none"> H3 12/55W bulb: H3 Relay 12 V/15A: 003530001 LED switch (green): H61923001 Accessories: <ul style="list-style-type: none"> White cover: 135236021 Black cover: H73146011 Clear cover: H87988081 Protective grill: 165530801 Cable harness: H84994031
HELLA 500 BLACK MAGIC 	HALOGEN <ul style="list-style-type: none"> Lightweight design Impact resistant ABS housing Aluminum vapor coated reflector The innovative black optics technology creates a only appearance when off. Glass lens <p>Kit - Content:</p> <ul style="list-style-type: none"> (2) Headlights, (2) H3 12V / 55W bulbs, (1) wire harness (2) Protective covers, (1) switch, (1) relay Mounting instructions and installation material 	<ul style="list-style-type: none"> Voltage: 12 VDC Light source: H3 12 V / 55 Watt Light pattern: Driving Power Consumption: 55 Watt Housing material: ABS (housing) Lens material: Glass Mounting: Zinc coated steel with black finish bracket Mounting Type: Vertical Connection: Wire leads Approval: SAE 	005750991 Kit Replacement parts: <ul style="list-style-type: none"> H3 12/55W bulb: H3 Relay 12 V/15A: 003530001 LED switch (green): H61923001 Accessories: <ul style="list-style-type: none"> Black cover: H73146011 Clear cover: H87988081 Protective grill: 165530801 Cable harness: H84994031
HELLA 500FF (REF. 37.5) 	HALOGEN <ul style="list-style-type: none"> Lightweight design Impact resistant ABS housing Aluminum vapor coated reflector with free form technology with glass lens <p>Single - Content:</p> <ul style="list-style-type: none"> (1) headlight, (1) H3 12 V / 55W bulb (1) protective cover Mounting instructions and installation components <p>Kit - Content:</p> <ul style="list-style-type: none"> (2) Headlights, (2) H3 12V / 55W bulbs, (1) wire harness (2) Protective covers, (1) switch, (1) relay Mounting instructions and installation material 	<ul style="list-style-type: none"> Voltage: 12 VDC Light source: H3 12 V / 55 Watt Light pattern: Driving Power Consumption: 55 Watt Housing material: ABS (housing) Lens material: Glass Mounting: Zinc coated steel bracket Mounting Type: Vertical Connection: Wire leads Approval: ECE 	005750401 Single 005750941 Kit Replacement parts: <ul style="list-style-type: none"> H3 12/55W bulb: H3 Relay 12 V/15A: 003530001 LED switch (green): H61923001 Accessories: <ul style="list-style-type: none"> Black Cover: H73146011 Clear cover: H87988081 Protective grill: 165530801 Cable harness: H84994031

Product Image / Dimensions	Features	Technical specifications	Part Number
<p>HELLA 700FF (REF. 37.5)</p>  <p style="writing-mode: vertical-rl; transform: rotate(180deg);">HALOGEN</p>	<ul style="list-style-type: none"> Lightweight design Impact resistant ABS housing Aluminum vapor coated reflector with free form technology with glass lens <p>Single - Content:</p> <ul style="list-style-type: none"> (1) headlight, (1) bulb H3 12 V / 55 Watt (1) protective cover Mounting instructions and installation components <p>Kit - Content:</p> <ul style="list-style-type: none"> (2) Headlights, (2) H3 12V / 55W bulbs, (1) wire harness (2) Protective covers, (1) switch, (1) relay Mounting instructions and installation material 	<ul style="list-style-type: none"> Voltage: 12 VDC Light source: H3 12 V / 55 Watt Light pattern: Driving Power Consumption: 55 Watt Housing material: ABS (housing) Lens material: Glass Mounting: Zinc coated steel bracket Mounting Type: Vertical Connection: Wire leads Approval: ECE 	<p>010032001 Single</p> <p>010032801 Kit</p> <p>Replacement parts:</p> <ul style="list-style-type: none"> H3 12/55W bulb: H3 Relay 12 V/15A: H84994031 LED switch (green): H61923001 <p>Accessories:</p> <ul style="list-style-type: none"> White cover: 173147001 Cable harness: H84994031
<p>HELLA 1000 BLACK MAGIC (REF. 17.5)</p>  <p style="writing-mode: vertical-rl; transform: rotate(180deg);">HALOGEN</p>	<ul style="list-style-type: none"> Super thin design Impact resistant ABS housing Aluminum vapor coated reflector The innovative black optics technology creates a only appearance when off <p>Single - Content:</p> <ul style="list-style-type: none"> (1) headlight, (1) H2 bulb (1) Protective cover and Mounting instructions <p>Kit - Content:</p> <ul style="list-style-type: none"> (2) Headlights, (2) H2 12 V / 55 Watt bulbs, (1) wire harness, (2) Protective covers, (1) switch, (1) relay, mounting instructions and components 	<ul style="list-style-type: none"> Voltage: 12 VDC Light source: H2 12 V / 55 Watt Light pattern: Driving Power Consumption: 55 Watt Housing material: ABS (housing) Lens material: Glass Mounting: Zinc coated steel bracket Mounting Type: Vertical Connection: Wire leads Approval: ECE 	<p>004700431 Single</p> <p>004700771 Kit</p> <p>Replacement parts:</p> <ul style="list-style-type: none"> H2 12/55W bulb: H2 Relay 12 V/15A: 003530001 <p>Accessories:</p> <ul style="list-style-type: none"> White cover: 130331001 Clear cover: H87988121 Cable harness: H84994031
<p>HELLA 550 (REF. 17.5)</p>  <p style="writing-mode: vertical-rl; transform: rotate(180deg);">HALOGEN</p>	<ul style="list-style-type: none"> Lightweight design Impact resistant ABS housing Aluminum vapor coated reflector and glass lens <p>Single - Content:</p> <ul style="list-style-type: none"> (1) headlight, 1 bulb H3 12 V / 55 Watt (1) Protective cover and Mounting instructions <p>Kit - Content:</p> <ul style="list-style-type: none"> (2) Headlights, (2) H2 12 V / 55 Watt bulbs, (1) wire harness (2) Protective covers, (1) switch, (1) relay Mounting instructions and installation components 	<ul style="list-style-type: none"> Voltage: 12 VDC Light source: H3 12 V / 55 Watt Light pattern: Driving Power Consumption: 55 Watt Housing material: ABS (housing) Lens material: Glass Mounting: Zinc coated steel bracket Mounting Type: Vertical / Hanging Connection: Without cables Approval: ECE / SAE 	<p>005700471 Single</p> <p>005700891 Kit</p> <p>Replacement parts:</p> <ul style="list-style-type: none"> H3 12/55W bulb: H3 LED switch (green): H61923001 <p>Accessories:</p> <ul style="list-style-type: none"> White cover: H87037001 Clear cover: H87988111 Cable harness: H84994031
<p>HELLA 550 FOG LIGHT</p>  <p style="writing-mode: vertical-rl; transform: rotate(180deg);">HALOGEN</p>	<ul style="list-style-type: none"> Lightweight design Impact resistant ABS housing Aluminum vapor coated reflector Glass lens <p>Single - Content:</p> <ul style="list-style-type: none"> (1) Headlight, 1 H3 12 V / 55 Watt bulb (1) Protective cover and Mounting instructions <p>Kit - Content:</p> <ul style="list-style-type: none"> (2) Headlights, (2) H2 12 V / 55 Watt bulbs, (1) wire harness (2) Protective covers, (1) switch, (1) relay Mounting instructions and installation components 	<ul style="list-style-type: none"> Voltage: 12 VDC Light source: H3 12 V / 55 Watt Light pattern: Fog Power Consumption: 55 Watt Housing material: ABS (housing) Lens material: Glass Mounting: Zinc coated steel bracket Weight: 1200 g Mounting Type: Vertical / Hanging Connection: Without cables Approval: ECE / SAE 	<p>005700441 Single</p> <p>Replacement parts:</p> <ul style="list-style-type: none"> H3 12/55W bulb: H3 LED switch (green): H61923001 <p>Accessories:</p> <ul style="list-style-type: none"> White cover: H87037001 Clear cover: H87988111 Cable harness: H84994031 

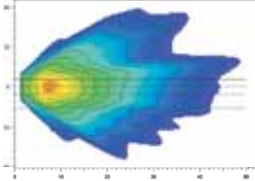
AUXILIARY LIGHTING

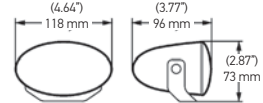
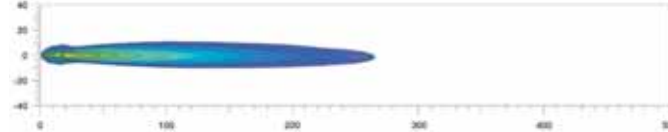
Product Image / Dimensions	Features	Technical specifications	Part Number
<p>HELLA 550 FOG LIGHT / AMBER</p> 	<p>HALOGEN</p> <ul style="list-style-type: none"> Lightweight design Impact resistant ABS housing Aluminum vapor coated reflector Classic design <p>Single - Content:</p> <ul style="list-style-type: none"> (1) headlight, (1) H3 12 V / 55W bulb (1) Protective cover and Mounting instructions <p>Kit - Content:</p> <ul style="list-style-type: none"> (2) Headlights, (2) H3 12V / 55W bulbs, (1) wire harness (2) Protective covers, (1) switch, (1) relay Mounting instructions and installation components 	<ul style="list-style-type: none"> Voltage: 12 VDC Light source: H3 12 V / 55W Light pattern: Fog Power Consumption: 55 Watt Housing material: ABS (housing) Lens material: Glass Mounting: Zinc coated steel bracket Mounting Type: Vertical / Hanging Connection: Without cables Approval: ECE / SAE 	<p>005700421 Single</p> <p>Replacement parts:</p> <ul style="list-style-type: none"> H3 12/55W bulb: H3 LED switch (green): H61923001 <p>Accessories:</p> <ul style="list-style-type: none"> White cover: H87037001 Clear cover: H87988111 Cable harness: H84994031
<p>HELLA 450 (Ref. 17.5)</p> 	<p>HALOGEN</p> <ul style="list-style-type: none"> Impact resistant ABS housing Aluminum vapor coated reflector Classic design <p>Single - Content:</p> <ul style="list-style-type: none"> (1) headlight, (1) bulb H3 12 V / 55W (1) Protective cover and Mounting instructions <p>Kit - Content:</p> <ul style="list-style-type: none"> (2) Headlights, (2) H3 12V / 55W bulbs, (1) wire harness (2) Protective covers, (1) switch, (1) relay Mounting instructions and installation material 	<ul style="list-style-type: none"> Voltage: 12 VDC Light source: H3 12 V / 55 Watt Light pattern: Driving Power Consumption: 55 Watt Housing material: ABS (housing) Lens material: Glass Mounting: Zinc coated steel bracket Mounting Type: Vertical / Hanging Connection: Wire leads Approval: ECE / SAE 	<p>005860231 Single</p> <p>Replacement parts:</p> <ul style="list-style-type: none"> H3 12/55W bulbs: H3 <p>Accessories:</p> <ul style="list-style-type: none"> White cover: 131000011 Clear cover: H87988071 Cable harness: H84994031
<p>HELLA 450 FOG LIGHT</p> 	<p>HALOGEN</p> <ul style="list-style-type: none"> Impact resistant ABS housing Aluminum vapor coated reflector with free form technology Glass lens <p>Single - Content:</p> <ul style="list-style-type: none"> (1) headlight, (1) H3 12 V / 55 Watt bulb (1) Protective cover and Mounting instructions <p>Kit - Content:</p> <ul style="list-style-type: none"> (2) Headlights, (2) H3 12V / 55W bulbs, (1) wire harness, (2) Protective covers, (1) switch, (1) relay Mounting instructions and installation components 	<ul style="list-style-type: none"> Voltage: 12 VDC Light source: H3 12 V / 55 Watt Light pattern: Fog Power Consumption: 55 Watt Housing material: ABS (housing) Lens material: Glass Mounting: Stainless steel bracket Mounting Type: Vertical Connection: Wire leads Approval: ECE / SAE 	<p>005860201 Single</p> <p>005860601 Kit</p> <p>Replacement parts:</p> <ul style="list-style-type: none"> H3 12/55W bulb: H3 Reflector unit: 137001021 <p>Accessories:</p> <ul style="list-style-type: none"> White cover: 131000011 Clear cover: H87988071 Cable harness: H84994031
<p>HELLA 450 FOG LIGHT - AMBER</p> 	<p>HALOGEN</p> <ul style="list-style-type: none"> Lightweight design Impact resistant ABS housing Aluminum vapor coated reflector Glass lens <p>Single - Content:</p> <ul style="list-style-type: none"> (1) Headlight (1) H3 12V / 55W bulb (1) Protective cover Mounting instructions and installation components 	<ul style="list-style-type: none"> Voltage: 12 VDC Light source: H3 12 V / 55 Watt Light pattern: Fog Power Consumption: 55 Watt Housing material: ABS (housing) Lens material: Glass Mounting: Stainless steel bracket Mounting Type: Vertical / Hanging Connection: Wire leads Approval: ECE 	<p>005860221 Single</p> <p>Replacement parts:</p> <ul style="list-style-type: none"> H3 12/55W bulb: H3 <p>Accessories:</p> <ul style="list-style-type: none"> White cover: 137000011 Clear cover: H87988071 Cable harness: H84994031

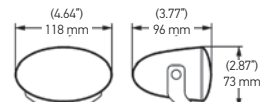
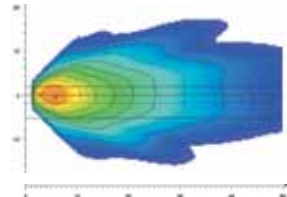
Product Image / Dimensions	Features	Technical specifications	Part Number
<p>FF 75 (REF. 12.5)</p> 	<p>HALOGEN</p> <ul style="list-style-type: none"> • Compact, long and flat design - convenient for tight spaces • Transparent glass lens / blue glass lens • Free form magnesium reflector for output optimal light • Magnesium offers a high thermal resistance that prevents deformation <p>Single - contains:</p> <ul style="list-style-type: none"> • (1) lamp, (1) H7 12 V / 55 Watt bulb • Mounting instructions and installation components <p>Kit - contains:</p> <ul style="list-style-type: none"> • (2) lamps, (2) H7 12 V / 55 Watt bulbs • (1) wire harness, (1) relay, (1) switch • Mounting instructions and installation components 	<ul style="list-style-type: none"> • Voltage: 12 VDC • Light source: H7 12 V / 55 Watt • Light pattern: Driving • Power Consumption: 55 Watt • Housing material: PVC • Lens material: Glass • Mounting: Stainless steel bracket • Mounting Type: Vertical / Hanging • Connection: Bulb connector • Approval: ECE / SAE 	<p>008284011 Single</p> <p>008284811 Kit</p> <p>Replacement parts:</p> <ul style="list-style-type: none"> • H7 12V /55W bulb: H7 <p>Accessories:</p> <ul style="list-style-type: none"> • White cover: H87236051 • Clear cover: H87988011 • Cable harness: H84994031
<p>FF 75 FOG LIGHT</p> 	<p>HALOGEN</p> <ul style="list-style-type: none"> • Compact, long and flat design - convenient for tight spaces • Transparent glass lens • Free form magnesium reflector for output optimal light • Magnesium offers a high thermal resistance that prevents deformation <p>Single - contains:</p> <ul style="list-style-type: none"> • (1) lamp, (1) H7 12 V / 55 Watt bulb • Mounting instructions and installation components <p>Kit - contains:</p> <ul style="list-style-type: none"> • (2) lamps, (2) H7 12 V / 55 Watt bulbs • (1) wire harness, (1) relay, (1) switch • Mounting instructions and installation components 	<ul style="list-style-type: none"> • Voltage: 12 VDC • Light source: H7 12 V / 55 Watt • Light pattern: Fog • Power Consumption: 55 Watt • Housing material: PVC • Lens material: Glass • Mounting: Stainless steel bracket • Mounting Type: Vertical / Hanging • Connection: Bulb connector • Approval: ECE / SAE 	<p>008284001 Single</p> <p>008284801 Kit</p> <p>Replacement parts:</p> <ul style="list-style-type: none"> • H7 12/55W bulb: H7 <p>Accessories:</p> <ul style="list-style-type: none"> • White cover: H87236051 • Clear cover: H87988011 • Cable harness: H84994031
<p>FF 50 (REF. 12.5)</p> 	<p>HALOGEN</p> <ul style="list-style-type: none"> • Compact, long and flat design - convenient for tight spaces • Transparent glass lens / blue glass lens • Free form magnesium reflector for output optimal light • Magnesium offers a high thermal resistance that prevents deformation <p>Single - contains:</p> <ul style="list-style-type: none"> • (1) lamp, (1) H7 12 V / 55W bulb • Mounting instructions and installation components <p>Kit - contains:</p> <ul style="list-style-type: none"> • (2) lamps, (2) H7 12 V / 55W bulbs • (1) wire harness, (1) relay, (1) switch • Mounting instructions and installation components 	<ul style="list-style-type: none"> • Voltage: 12 VDC • Light source: H7 12 V / 55 Watt • Light pattern: Driving • Power Consumption: 55 Watt • Housing material: PVC • Lens material: Glass • Mounting: Stainless steel bracket • Mounting Type: Vertical / Hanging • Connection: Bulb connector • Approval: ECE / SAE 	<p>008283011 Single</p> <p>008283811 Kit</p> <p>Replacement parts:</p> <ul style="list-style-type: none"> • H7 12/55W bulb: H7 <p>Accessories:</p> <ul style="list-style-type: none"> • Clear cover: H87988001 • Cable harness: H84994031
<p>FF 50 FOG LIGHT</p> 	<p>HALOGEN</p> <ul style="list-style-type: none"> • Compact, long and flat design - convenient for tight spaces • Transparent glass lens / blue glass lens • Free form magnesium reflector for optimal light output. Magnesium offers a high thermal resistance that prevents deformation <p>Single - contains:</p> <ul style="list-style-type: none"> • (1) lamp, (1) H7 12 V / 55W bulb, manual installation instructions and components <p>Kit - contains:</p> <ul style="list-style-type: none"> • (2) lamps, (2) H7 12 V / 55W bulbs • (1) wire harness, (1) relay, (1) switch • Mounting instructions and installation components 	<ul style="list-style-type: none"> • Voltage: 12 VDC • Light source: H7 12 V / 55 Watt • Light pattern: Fog • Power Consumption: 55 Watt • Housing material: PVC • Lens material: Glass • Mounting: Stainless steel bracket • Mounting Type: Vertical / Hanging • Connection: Bulb connector • Approval: ECE / SAE 	<p>008283801 Kit</p> <p>Replacement parts:</p> <ul style="list-style-type: none"> • H7 12/55W bulb: H7 <p>Accessories:</p> <ul style="list-style-type: none"> • Clear cover: H87988001 • Cable harness: H84994031

AUXILIARY LIGHTING

Product Image / Dimensions	Features	Technical specifications	Part Number
<p>MICRO DE</p> 	<p>HALOGEN</p> <ul style="list-style-type: none"> • New update style for one of our most popular lamps • Magnesium housing and reflector <p>Single - contains:</p> <ul style="list-style-type: none"> • (1) lamp, (1) H3 12 V / 55 Watt bulb • Mounting instructions and components for installation <p>Kit - contains:</p> <ul style="list-style-type: none"> • (2) lamps, (2) H3 12 V / 55 Watt bulbs • (1) wire harness, (1) relay, (1) switch • Mounting instructions and components for installation 	<ul style="list-style-type: none"> • Voltage: 12 VDC • Light source: H3 12 V / 55 Watt • Light pattern: Fog • Power Consumption: 55 Watt • Housing material: Magnesium • Lens material: Glass • Mounting: Stainless steel bracket • Mounting Type: Vertical / Hanging • Connection: Bulb connector • Approval: ECE / SAE 	<p>008090961 Single</p> <p>008090951 Kit</p> <p>Replacement parts:</p> <ul style="list-style-type: none"> • H3 12 V / 55W bulb: H3 • Rubber plug: 147009007 <p>Accessories:</p> <ul style="list-style-type: none"> • Wire harness: H84994031 • Adjustable bracket: 153152001

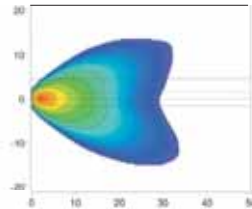
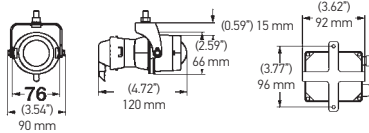

90 MM LED MODULES

The new L4060 LED series is the new addition to the range of 90 millimeter LED modules. This makes HELLA the only supplier in the market to provide a replacement concept for all 90 millimeter halogen modules using LED technology. The design of the new module is very compact and allows three light functions in one module without additional electronics. The resistant cover plate of polycarbonate and the cast aluminum housing are extremely robust and can withstand even tougher loads. The new L4060 LED series give you more illumination and safety with innovative LED technology.

90 MM CONFIGURATOR

This tool shows you the options for equipping or upgrading a vehicle with 90 mm LED modules. See images from Europe's biggest light testing facility and compare the light distribution of halogen and LED modules, in order to help you make the right choice for your application.



www.hella.com/90mm-modules



Product Image / Dimensions	Features	Additional Information	Part Number
----------------------------	----------	------------------------	-------------

L4060 LED
BI-LED GEN II
HIGH / LOW BEAM

LED

- Headlight module
- Polycarbonate lens
- Cast aluminum housing
- Black finish cover
- Dipped beam: 20 Watt
- Voltage: 9 - 33 V
- Connection: DT connector
- Approval: SAE / ECE

Mounting:

- Flush

Applications:

- Universal application
- Headlight update

Content:

- 1 Headlights, Mounting instructions and installation components

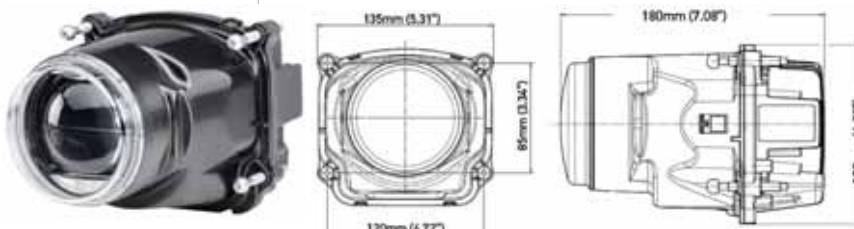

012758121 Homologation SAE





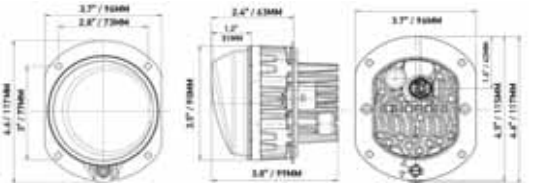

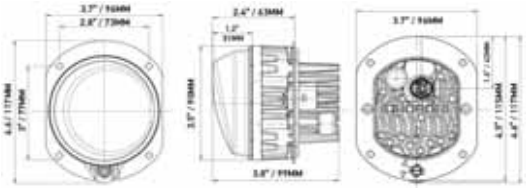
AUXILIARY LIGHTING

90 MM LED MODULES

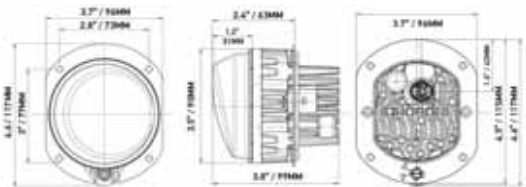
Product Image / Dimensions	Features	Additional Information	Part Number
<p>L4060 LED LED HIGH BEAM WITH DAYTIME RUNNING/ POSITION LIGHT</p>  <p>Pre-mounted carrier frame</p>	<p>LED</p> <ul style="list-style-type: none"> Headlamp module with low beam, position and daylight (DRL) Polycarbonate lens Cast aluminum housing Silver design cover Black finish cover on request Voltage: 9 - 32 VDC Power Consumption: 20 Watt Integrated 4-pin DT connector Approval: ECE / SAE 	<p>Mounting:</p> <ul style="list-style-type: none"> Flush <p>Applications:</p> <ul style="list-style-type: none"> Universal application Headlight update <p>Content:</p> <ul style="list-style-type: none"> 1 Headlight, Mounting instructions and installation components 	<p>011988031 Pre-mounted carrier frame</p> <p>011988131 Performance mount</p> <p>202117001 DT conversion connector</p> 
<p>L4060 LED LED HIGH BEAM</p>  <p>Pre-mounted carrier frame</p>	<p>LED</p> <ul style="list-style-type: none"> Headlight module Polycarbonate lens Cast aluminum housing Silver design cover Black finish cover on request Voltage: 9 - 32 VDC Power Consumption: 20 Watt Integrated 4-pin FEP connector (Power connector DT conversion available - sold separately) Approval: ECE / SAE 	<p>Mounting:</p> <ul style="list-style-type: none"> Flush <p>Applications:</p> <ul style="list-style-type: none"> Universal application Headlight update <p>Content:</p> <ul style="list-style-type: none"> 1 Headlight, Mounting instructions and installation components 	<p>011988021 Pre-mounted carrier frame</p> <p>011988121 Performance mount</p> <p>202117001 DT conversion connector</p> 
<p>L4060 LED LED HIGH BEAM WITH TURN SIGNAL</p> 	<p>LED</p> <ul style="list-style-type: none"> Headlight module Polycarbonate lens Cast aluminum housing Silver design cover Black finish cover on request Only for vehicles below 80" in width Voltage: 9 - 32VDC Power Consumption: 20 Watt Integrated 4-pin FEP connector (Power connector DT conversion available - sold separately) Approval: ECE / SAE 	<p>Mounting:</p> <ul style="list-style-type: none"> Flush <p>Applications:</p> <ul style="list-style-type: none"> Universal application Headlight update <p>Content:</p> <ul style="list-style-type: none"> 1 Headlight, Mounting instructions and installation components 	<p>011988071 With carrier frame without pulse generator</p> <p>011988171 Performance mount without pulse generator</p> <p>202117001 DT conversion connector</p> 
<p>L4060 LED FOG LIGHT WITH CURVE LIGHT</p> 	<p>LED</p> <ul style="list-style-type: none"> Headlight module Polycarbonate lens Cast aluminum housing Silver design cover Black finish cover on request Voltage: 9 - 32VDC Power Consumption: 20 Watt Integrated 4-pin FEP connector (Power connector DT conversion available - sold separately) Approval: ECE / SAE 	<p>Mounting:</p> <ul style="list-style-type: none"> Flush <p>Applications:</p> <ul style="list-style-type: none"> Universal application Headlight update <p>Content:</p> <ul style="list-style-type: none"> 1 Headlight, Mounting instructions and installation components 	<p>011988051 Light Left Hand</p> <p>011988061 Light Right Hand</p> 

Product Image / Dimensions	Features	Additional Information	Part Number
L4060 LED LED FOG LIGHT 	LED <ul style="list-style-type: none"> • Headlight module • Polycarbonate lens • Cast aluminum housing • Silver design cover • Black finish cover on request • Voltage: 9 - 32 VDC • Power Consumption: 20 Watt • Integrated 4-pin FEP connector (Power connector DT conversion available - sold separately) • Approval: SAE 	Mounting: <ul style="list-style-type: none"> • Flush Applications: <ul style="list-style-type: none"> • Universal application • Headlight update Content: <ul style="list-style-type: none"> • (1) Headlight, Mounting instructions and installation components 	011988001 Pre-mounted carrier frame 202117001 DT conversion connector
			

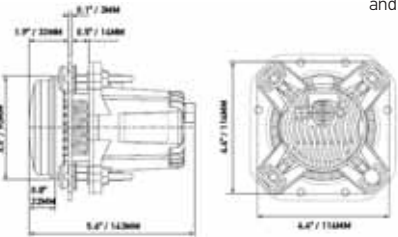
L4060 LED LED FOG LIGHT WITH DAYTIME RUNNING/ POSITION LIGHT 	LED <ul style="list-style-type: none"> • Headlight module • Polycarbonate lens • Cast aluminum housing • Silver design cover • Black finish cover on request • Voltage: 9 - 32 VDC • Power Consumption: 20 Watt • Integrated 4-pin FEP connector (Power connector DT conversion available - sold separately) • Approval: SAE 	Mounting: <ul style="list-style-type: none"> • Flush Applications: <ul style="list-style-type: none"> • Universal application • Headlight update Content: <ul style="list-style-type: none"> • (1) Headlight, Mounting instructions and installation components 	011988011 Pre-mounted carrier frame 202117001 DT conversion connector
			

L4060 LED LED LOW BEAM 	LED <ul style="list-style-type: none"> • Headlight module • Polycarbonate lens • Cast aluminum housing • Silver design cover • Voltage: 9 - 32 VDC • Power Consumption: 20 Watt • Integrated DT connector • Approval: SAE / ECE 	Mounting: <ul style="list-style-type: none"> • Flush Applications: <ul style="list-style-type: none"> • Universal application • Headlight update Content: <ul style="list-style-type: none"> • (1) Headlight, Mounting instructions and installation components 	012488101 012488121 With Daytime Running /Position Light
			

90 MM LED - ACCESSORIES AND SPARE PARTS

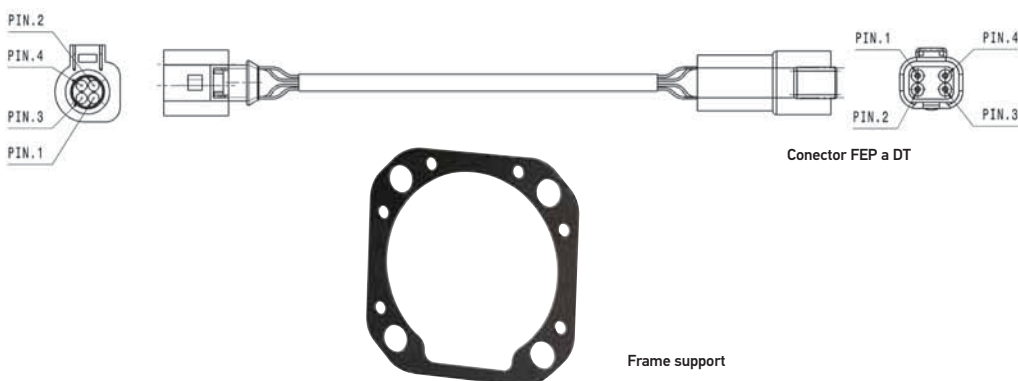

169580011 Frame support
202117001 FEP to DT connector



CONVERSION HEADLAMPS

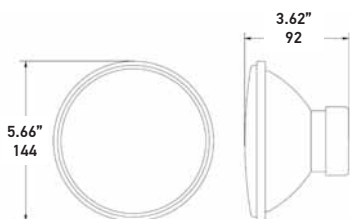

5 1/4" Sealed Beam Conversion Headlamps

Ideal For
Retrofitting
Replaces old sealed beam lighting technology

Features
Produces 50% more powerful beam on low beam
Produces 25% more powerful beam on high beam
Single lamp fits left or right
ECE versions for off-road use only in USA
Dust boots included

002850811
High/Low Beam (ECE), Kit, 2 H4 12 V 60/55W Bulbs, 2 Wiring Adapter
Harnesses

002850871
High/Low Beam (ECE), 1 H4 12 V 60/55W Bulb, 1 Wiring Adapter Harness

002425811
High Beam (ECE), Kit, 2 H1 12 V 55W Bulbs, 4 Adapter Wires

002425901
High Beam (ECE), 1 H1 12 V 55W Bulb, 2 Adapter Wires

Product image /
Dimensions

Features

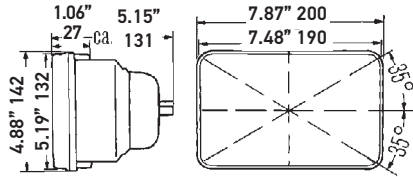

Vision Plus 6" x 7" Rectangular Conversion Headlamps

Ideal For
Retrofitting
Replaces old sealed beam lighting technology

Features
Based on European headlamp technology
Brighter than a standard halogen due to improved optics without increased glare
Produces 50% more powerful beam on low beam
Produces 25% more powerful beam on high beam
Single lamp fits left or right
Replaces standard sealed beam 6052, 6053, H6052, H6054
Direct fit – no modification
Dust boots included
ECE versions for off-road use only in the USA

Part Number **003427811** High/Low Beam (ECE), Kit, 2 H4 12 V 60/55W Bulbs
003427291 High/Low Beam (SAE/DOT), 1 HB2/9003 12 V 60/55W Bulb
003427861 High/Low Beam (ECE), 1 H4 12 V 60/55W Bulb

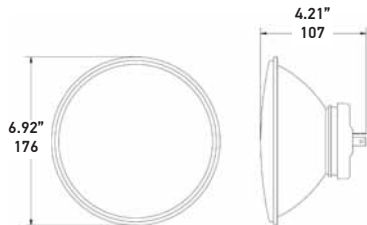

Vision Plus 7" Round Conversion Headlamps

Ideal For
Retrofitting older sealed beam lamps to newer halogen replaceable bulbs

Features
Based on European headlamp technology
Brighter than a standard halogen due to improved optics without increased glare
Produces 50% more powerful beam on low beam
Produces 25% more powerful beam on high beam
Single lamp fits left or right
Replaces 6012, 6014, 6015, 6016, 6017, H6024, H6014, H6017, H6026
Direct replacement for older sealed beam bulbs – no modifications
Direct fit – no modification
Dust boots included

Part Number **002395801** High/Low Beam (ECE), Kit, 2 H4 12 V 60/55W Bulbs
002395301 High/Low Beam (SAE/DOT), 1 HB2/9003 12 V 60/55W Bulb
002395991 High/Low Beam (ECE), 1 H4 12 V 60/55W Bulb

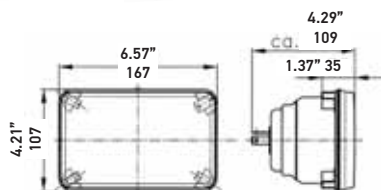

4" x 6" Rectangular Conversion Headlamps

Ideal For
Retrofitting
Replaces old sealed beam lighting technology

Features
Produces 50% more powerful beam on low beam
Produces 25% more powerful beam on high beam
Single lamp fits left or right
ECE versions for off-road use only in USA
Dust boots included

Part Number **003177801** High/Low Beam (ECE), Kit, 2 H4 12 V 60/55W Bulbs, 2 Wiring Adapter Harnesses
003177862 High/Low Beam (ECE), 1 H4 12 V 60/55W Bulb, 1 Wiring Adapter Harness
003177821 High Beam (ECE), Kit, 2 H1 12 V 55W Bulbs, 4 Adapter Wires
003177871 High Beam (ECE), 1 H1 12 V 55W Bulb, 2 Adapter Wires

4.21"
107

AUXILIARY LIGHTING

DIGITAL TOOLS



PRODUCT DETAILS

www.myhellalights.com

HELLA has adopted new communication technologies and provides a series of supporting information pages through the Internet. As a dynamic media, these pages are updated continuously and the websites grow online according to the needs of the customers.

Under www.myhellalights.com you will find photographs and 360° views of many of the products such as auxiliary lamps, as well as light bulbs, windshield wiper blades, speakers, the OPTILUX product range and much more.



www.myhellalights.com



ELIVER - Light simulations

Our online tool, Eliver, allows you to directly compare different lamps. All modules can be tested in a realistic 3D environment. Eliver also offers you the possibility to download the technical data sheets of the selected lamps.

All information, all lamps in just one click.

www.hella.com/MicroSite/eliver_US-Version



www.hella.com/MicroSite/eliver_US-Version



HELLA ADDLIGHT

**Search, select and virtually install auxiliary lamps
HELLA in your vehicle**

The new HELLA application allows you to virtually install your favorite auxiliary lights directly on a photo of your vehicle.

It is easy:

1. Install the application on your smartphone using the QR code.
2. Download the free HELLA application to your Smartphone or Tablet using the QR code of www.hella.com/apps or directly from iTunes and Google Play (Apple iOS or Android) and you're ready.



www.hella.com/apps



ORIGINAL PARTS

Functional safety, a perfect fit and product durability



NIGHTDRIVE - Learn the latest in lighting innovations with features in a 3D environment, available on Apple Store and Google Play

VEHICLES SPECIFIC LIGHTING

HELLA offers three guarantees with its wide range of lighting products for specific vehicles: better functionality, perfect fit and lasting customer satisfaction. All spare parts are manufactured to the same specifications and quality standards as the parts HELLA manufactures for its customers of original equipment worldwide. Through our technological innovations it allows us to continually develop our range of products such as lamps, taillights and interior lights.

HELLA is a world leader in automotive lighting technology and is a provider of many OE brands. HELLA has helped transform halogen lighting systems to xenon AFS and now to LED matrix systems that make lighting our exclusive technology.

Find lighting parts for specific vehicles at:



www.partcat.com/hella



New!
LED Bulbs

HELLA BULBS: In combination with the lamps, taillights and other lighting components, the bulbs play a key role in providing good road lighting and optimal visibility to the vehicle.

This means that they are a crucial safety factor. Enough reason to choose the best quality when selecting the right bulb. So trust HELLA: our products cover a wide range of applications, for example: passenger cars, commercial vehicles and agricultural vehicles. Always enjoy optimal visibility, with HELLA!



www.myhellalights.com



SHAPELINE
DESIGN YOUR LIGHT

www.hella.com/shapeline

INDIVIDUAL LIGHTING SIGNATURE!

The variety and range of shapes and the various combination options paired with a technically optimized product design make the new Shapeline series a true innovation in vehicle lighting.

Whether the front, side or rear of a vehicle, whatever size or series, being it small or large. Shapeline offers a unique and, above all, consistent look using a customized configuration and arrangement of lamps. This allows us to meet the demands of vehicle manufacturers with lower numbers of manufactured vehicles. Along with innovative variety of shapes of Shapeline lamps provide you with nearly infinite design freedom.

Tech or Style: The HELLA Shapeline series provides design freedom for nearly any application and vehicle, achieves a consistent light signature for your vehicle at the same time.

Design your light – with HELLA Shapeline!

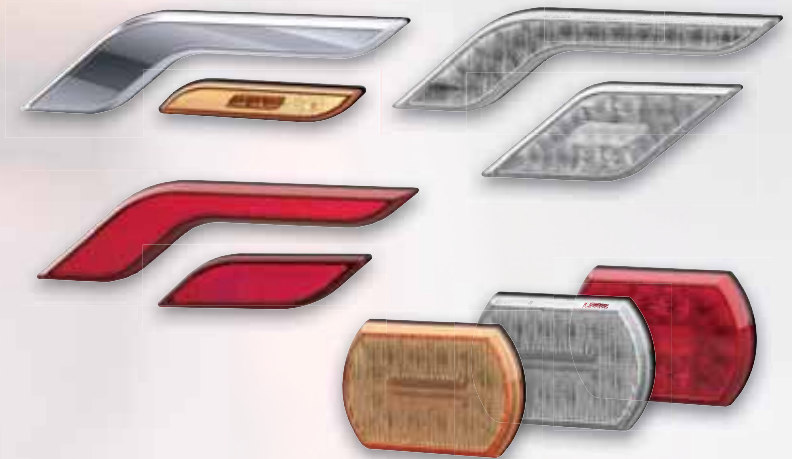

DESIGN WITH EASE

www.hella.com/shapeline

- Premium Design
- Customizable
- ECE and SAE
- Multivolt
- Robust
- Simple



HELLA *VALUEFIT*





MICROSITE: Find more information about Hella VALUEFIT work lights at:



www.hellahd.com

HELLA VALUEFIT

Products for the toughest working conditions

HELLA VALUEFIT offers entry-level access to LED technology and represents a good solution for converting from halogen to LED. Compared to halogen work lights, LED work lights offer considerably better light output. The substantially higher color temperature of 6,000 Kelvin is very similar to natural daylight. This makes it easier to distinguish between different colors in the dark and, in turn, prevents the eyes from tiring quickly during work at night. VALUEFIT LED work lights are completely maintenance-free and offer a much longer service life than the bulb of a halogen headlamp.

HELLA products are measured in our inhouse state of the art light laboratory. Hella is proud to be one of a few, who actually just advertise the **real measured lumen** for our light output. Be aware that a lot of competitors advertise their products with a theoretical raw or calculated light output, which can be far off the actual light output you get. With Hella you can be sure, that the lights will meet your expectations and do provide the right amount of light for every application.



The products in this section can expose you to chemicals including Di(2-ethylhexyl) phthalate (DEHP), which is known to the State of California to cause cancer and birth defects or other reproductive harm. For more information go to www.P65Warnings.ca.gov

INTRODUCING OUR NEW 450 LED & 500 LED

Perfect replacement of your traditional Halogen Auxiliary lights. Equal in size and shape, but much higher light performance combined with a modern design and longer durability.

NEW



500 LED DRIVING LAMP

LED



2100 lm

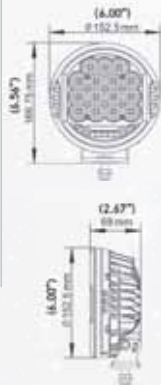

Round LED Auxiliary light with high performance LEDs and stylish PO light. The 500 LED comes with a black stone shield cover. 2100 measured lumen and IP67 protection Off-road use only. Amber cover converts the 500 LED to a Fog lamp for dusty or foggy environments.

Kit contains: (2) LED driving lights, stone shields, mounting brackets and hardware, (1) relay, switch and wiring harness

Voltage	10-30 VDC
Light pattern:	Driving Beam
Light source:	LED
Power consumption:	22.5 Watt
Color temperature:	6000 Kelvin
Housing material:	Aluminum
Connection:	Wire leads (Single) / DT connector (Kit)
Mounting:	Stainless steel bracket
Dimensions:	6.0" x 6.6" x 2.7" / 153 x 167 x 68 mm (WxHxD)
Approvals:	CE, ECE-R10, ECE-R112, IP67
Part Number	358117161 Single 358117171 Kit 358116991 Amber stone shield

450 LED DRIVING LAMP

LED



3000 lm

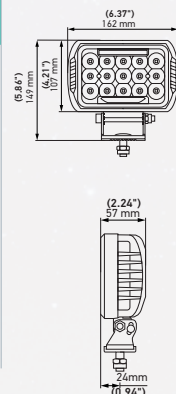

Rectangular LED Auxiliary light with high performance LEDs and stylish PO light. The 450 LED comes with a black stone shield cover. 3000 measured lumen and IP67 protection. Off-road use only.

Kit contains: (2) LED driving lights, stone shields, mounting brackets and hardware, (1) relay, switch and wiring harness.

Voltage	10-30 VDC
Light pattern:	Driving Beam
Light source:	LED
Power consumption:	75 Watt
Color temperature:	6000 Kelvin
Housing material:	Aluminum
Connection:	Wire leads
Mounting:	Stainless steel bracket
Dimensions:	6.4" x 5.9" x 2.2" / 162 x 149 x 57 mm (WxHxD)
Approvals:	CE, ECE-R10, ECE-R112, IP67
Part Number	358154041 Single 358154051 Kit 358154061 Amber stone shield

HELLA VALUEFIT

PRODUCT RANGE

Product image / Dimensions	Features
----------------------------	----------

4LED CUBE

LED



600 lm

Flood Beam



690 lm

Spot Beam

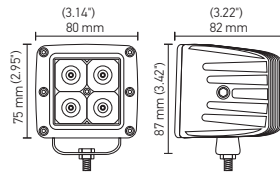

Compact LED cubes with great light distribution, both in flood and spot beam pattern. The wide 90 degree spread flood beams provide perfect light conditions around your vehicle. The far reaching spot beams provide additional light in front of your vehicle. 1 year warranty.

Kit contains: (2) LED lights, mounting brackets and hardware, (1) relay, switch and wiring harness with DT connector

Voltage	10-30 VDC
Light pattern:	Spot Beam / Flood Beam
Light source:	LED
Power consumption:	12 Watt / 24 Watt (Kit)
Color temperature:	6000 Kelvin
Housing material:	Aluminum
Connection:	Wire leads (Single) / DT connector (Kit)
Mounting:	Stainless steel bracket
Dimensions:	3.1" x 3.4" x 3.2" / 80 x 75 x 82 mm (WxHxD)
Approvals:	IP67

Part Number

- 357204821** Kit, Spot Beam, Black housing
- 357204031** Flood Beam, Black housing
- 357204041** Flood Beam, White housing
- 357204831** Kit, Flood Beam, Black housing

6LED CUBE

LED



600 lm

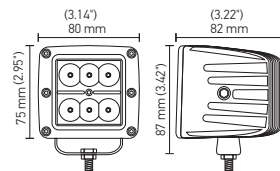

The compact square design combined with 6 powerful LEDs are the perfect combination for you. Available as surface bracket mount or with a special flush mount cover to install it direct into the bumper. 1 year warranty

Voltage	10-30 VDC
Light pattern:	Flood Beam
Light source:	LED
Power consumption:	18 Watt
Color temperature:	6000 Kelvin
Housing material:	Aluminum
Connection:	Wire leads
Mounting:	Stainless steel bracket
Dimensions:	3.1" x 3.4" x 3.2" / 80 x 75 x 82 mm (WxHxD)
Approvals:	IP67

Part Number

- 357204051** Flood Beam

6LED CUBE

LED



1000 lm

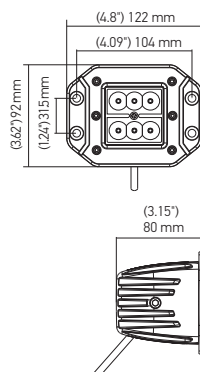

6LED Cube Flush Mount

The compact square design combined with 6 powerful LEDs are the perfect combination for you. Available as surface bracket mount or with a special flush mount cover to install it direct into the bumper. 1 year warranty

Voltage	10-30 VDC
Light pattern:	Flood Beam
Light source:	LED
Power consumption:	18 Watt
Color temperature:	6000 Kelvin
Housing material:	Aluminum
Connection:	Wire leads
Mounting:	Stainless steel bracket
Dimensions:	4.8" x 3.6" x 3.1" / 122 x 92 x 80 mm (WxHxD)
Approvals:	IP67

Part Number

- 357204021** Flood Beam

HELLA VALUEFIT PRODUCT RANGE

Product image / Dimensions	Features
----------------------------	----------

7" ROUND

LED



1080 lm

Driving Beam



3000 lm

Spot Beam

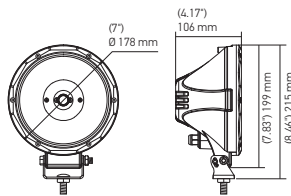

Classic 7" round Aux lights reflector design combined with modern LED technology. Powerful spot beam provides a bright and narrow light beam for good sight and safe maneuvering on and off the road. 1 year warranty

Voltage	10-30 VDC
Light pattern:	Driving Beam
Light source:	LED
Power consumption:	20 Watt
Color temperature:	6000 Kelvin
Housing material:	Aluminum
Connection:	Wire leads
Mounting:	Stainless steel bracket
Dimensions:	7.0" x 8.5" x 4.2" / 178 x 178 x 106 mm (WxHxD)
Approvals:	IP67 /SAE, ECE (Driving Beam)

Part Number
357200001 Driving Beam
357200011 Spot Beam

90MM SPOT LIGHT

LED



1000 lm

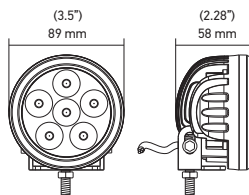

The compact round design combined with 6 powerful LEDs are the perfect combination for you. Available as surface bracket mount or with a special flush mount cover to install it direct into the bumper. 1 year warranty

Voltage	10-30 VDC
Light pattern:	Spot Beam
Light source:	LED
Power consumption:	18 Watt
Color temperature:	6000 Kelvin
Housing material:	Aluminum
Connection:	Wire leads
Mounting:	Stainless steel bracket
Dimensions	3.5" x 3.5" x 2.3" / 89 x 89 x 58 mm (WxHxD)
Approvals:	IP67

Part Number
357201001 Spot Beam

90MM SPOT LIGHT FLUSH MOUNT

LED



1000 lm

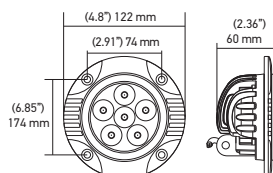

The compact round design combined with 6 powerful LEDs are the perfect combination for you. Available as surface bracket mount or with a special flush mount cover to install it direct into the bumper. 1 year warranty

Voltage	10-30 VDC
Light pattern:	Spot Beam
Light source:	LED
Power consumption:	18 Watt
Color temperature:	6000 Kelvin
Housing material:	Aluminum
Connection:	Wire leads
Mounting:	Stainless steel bracket
Dimensions	4.8" x 4.8" x 2.4" / 122 x 122 x 60 mm (WxHxD)
Approvals:	IP67

Part Number
357201011 Spot Beam

Product image / Dimensions	Features
----------------------------	----------

6LED MINN LIGHTBAR

LED



1000 lm

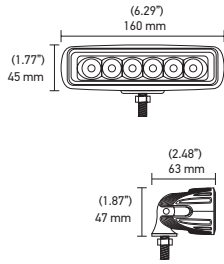

Thanks to its 6 high power LEDs, it is a top seller in this range. The low profile shape and the adjustable mounting bracket make this lamp a desired addition to any vehicle. 1 year warranty

Voltage	10-30 VDC
Light pattern:	Flood Beam
Light source:	LED
Power consumption:	18 Watt
Color temperature:	6000 Kelvin
Housing material:	Aluminum
Connection:	Wire leads
Mounting:	Stainless steel bracket
Dimensions	6.3" x 1.8" x 2.5" / 160 x 45 x 63 mm (WxHxD)
Approvals:	IP67
Part Number	357203001 Flood, Black housing 357203051 Flood, White housing

6LED MINI LIGHTBAR

LED



1000 lm

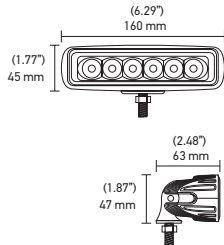

Thanks to its 6 high power LEDs, it is a top seller in this range. The low profile shape and the adjustable mounting bracket make this lamp a desired addition to any vehicle. 1 year warranty

Voltage	10-30 VDC
Light pattern:	Flood Beam
Light source:	LED
Power consumption:	18 Watt
Color temperature:	6000 Kelvin
Housing material:	Aluminum
Connection:	Wire leads
Mounting:	Stainless steel bracket
Dimensions	6.3" x 1.8" x 2.5" / 160 x 45 x 63 mm (WxHxD)
Approvals:	IP67
Part Number	357203011 Spot, Black housing

6LED MINI LIGHTBAR FLUSH MOUNT

LED



1000 lm

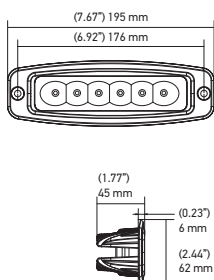

Thanks to its 6 high power LEDs, it is a top seller in this range. The low profile shape and the adjustable mounting bracket make this lamp a desired addition to any vehicle. The flush mount housing works perfect for the install direct into the bumper. 1 year warranty

Voltage	10-30 VDC
Light pattern:	Flood Beam
Light source:	LED
Power consumption:	18 Watt
Color temperature:	6000 Kelvin
Housing material:	Aluminum
Connection:	Wire leads
Mounting:	Stainless steel bracket
Dimensions	7.7" x 2.4" x 1.8" / 195 x 62 x 45 mm (WxHxD)
Approvals:	IP67
Part Number	357203031 Flood, Black Housing

HELLA VALUEFIT LBX SERIES

NEW

- 1 **Combo Beam.** A combination of a spot beam and flood beam for the LBX-540 & LBX-720
- 2 **Diecast Aluminum Housing** able to withstand the elements.
- 3 **Aluminum Alloy Brackets** for sturdy upright mounting. A perfect fit for roof, grille and bumper mounting.
- 4 An all around professional LED light bar, a perfect fit for your next race to out shine the competition!



Color Temperature

→ Color temperature is close to natural daylight.
Drivers operating in such lighting conditions
stay alert longer.

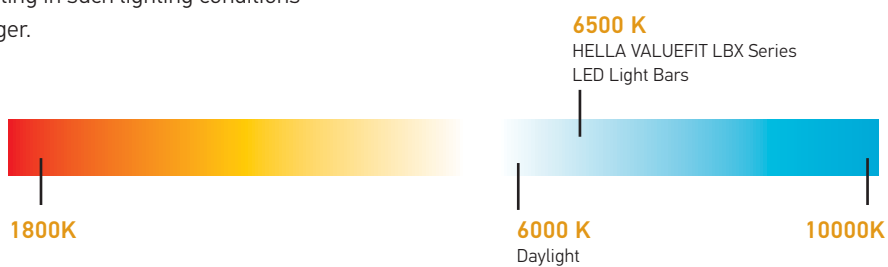

Product image / Dimensions	Features
----------------------------	----------

LBX 220 LED - 8"

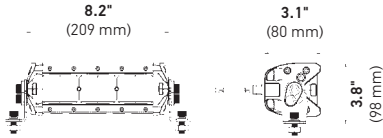

1000 lm

Innovative lens design for stealth look. Low mounting position offers exceptional ground illumination. 1 year warranty

Voltage	9-30 VDC
Light pattern:	Flood Beam
Light source:	LED
Power consumption:	22 Watt
Color temperature:	6500 Kelvin
Housing material:	Aluminum
Connection:	Integrated DT connector + 7ft (2000mm) adapter cable with open wires
Mounting:	Stainless steel bracket
Dimensions	8.2" x 3.8" x 3.1" / 209 x 98 x 80 mm (WxHxD)
Approvals:	CE, ECE-R10, IP67
Part Number	36000002 Close Range

LBX 380 LED - 14"

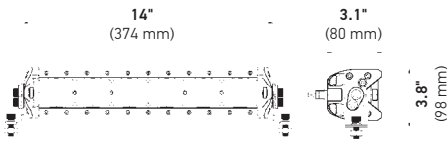

2000 lm

Innovative lens design for stealth look. Low mounting position offers exceptional ground illumination. 1 year warranty

Voltage	9-30 VDC
Light pattern:	Flood Beam
Light source:	LED
Power consumption:	44 Watt
Color temperature:	6500 Kelvin
Housing material:	Aluminum
Connection:	Integrated DT connector + 7ft (2000mm) adapter cable with open wires
Mounting:	Stainless steel bracket
Dimensions	14.0" x 3.8" x 3.1" / 374 x 98 x 80 mm (WxHxD)
Approvals:	CE, ECE-R10, IP67
Part Number	36001002 Combo Beam

LBX 540 LED - 21"

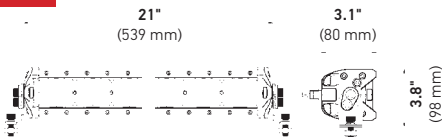

3500 lm

SAE APPROVED

Innovative lens design for stealth look. Low mounting position offers exceptional ground illumination. The combination of Flood and Spot reflectors creates a far and wide illumination for maximum visibility at night. 1 year warranty

Voltage	9-30 VDC
Light pattern:	Combo Beam
Light source:	LED
Power consumption:	66 Watt
Color temperature:	6500 Kelvin
Housing material:	Aluminum
Connection:	Integrated DT connector + 7ft (2000mm) adapter cable with open wires
Mounting:	Stainless steel bracket
Dimensions	21" x 3.8" x 3.1" / 539 x 98 x 80 mm (WxHxD)
Approvals:	CE, ECE-R10, ECE-R112, SAE approved, IP67
Part Number	36002002 Combo Beam

LBX 720 LED - 27"

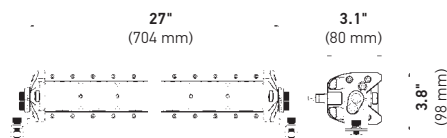

5500 lm

Innovative lens design for stealth look. Low mounting position offers exceptional ground illumination. The combination of Flood and Spot reflectors creates a far and wide illumination for maximum visibility at night. 1 year warranty

Voltage	9-30 VDC
Light pattern:	Combo Beam
Light source:	LED
Power consumption:	88 Watt
Color temperature:	6500 Kelvin
Housing material:	Aluminum
Connection:	Integrated DT connector + 7ft (2000mm) adapter cable with open wires
Mounting:	Stainless steel bracket
Dimensions	27" x 3.8" x 3.1" / 704 x 98 x 80 mm (WxHxD)
Approvals:	CE, ECE-R10, ECE-R112, IP67
Part Number	36003002

HELLA VALUEFIT SPORT SERIES

- 1 Combo Beam.** A combination of a spot beam and flood beam.
- 2 Diecast Aluminum Housing** able to withstand the elements.
- 3 Aluminum Alloy Brackets** for sturdy upright mounting. A perfect fit for roof, grille and bumper mounting.
- 4** Get that off-road look whether you're on the street or blazing the trails!



Color Temperature

→ Color temperature is close to natural daylight.
Drivers operating in such lighting conditions
stay alert longer.



6000 K
HELLA VALUEFIT Sport Series
LED Light Bars

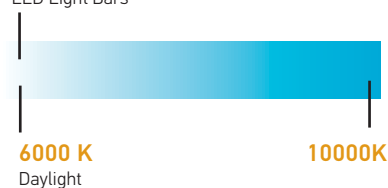

Product image / Dimensions	Features
----------------------------	----------

12 LED SPORT SERIES - 8"



1200 lm

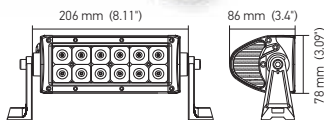

The double row reflector gives this SPORT SERIES its modern look and great light performance. 1 year warranty

Voltage	10-30 VDC
Light pattern:	Flood Beam
Light source:	LED
Power consumption:	36 Watt
Color temperature:	6000 Kelvin
Housing material:	Aluminum
Connection:	Wire leads
Mounting:	Stainless steel bracket
Dimensions	8.1" x 3.0" x 3.4" / 206 x 78 x 86 mm (WxHxD)
Approvals:	IP67
Part Number	357208001 Black housing 357208011 White housing

40 LED SPORT SERIES - 22"



4300 lm

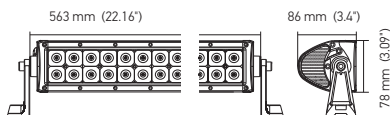

The double row reflector gives this SPORT SERIES its modern look and great light performance. The combination of Flood and Spot reflectors creates a far and wide illumination for maximum visibility at night. 1 year warranty

Voltage	10-30 VDC
Light pattern:	Combo Beam
Light source:	LED
Power consumption:	120 Watt
Color temperature:	6000 Kelvin
Housing material:	Aluminum
Connection:	Wire leads
Mounting:	Stainless steel bracket
Dimensions	22.1" x 3.1" x 3.4" / 558 x 78 x 86 mm (WxHxD)
Approvals:	IP67
Part Number	357208101 Combo beam

60 LED SPORT SERIES - 32"



5900 lm

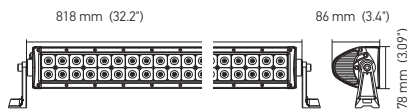

The double row reflector gives this SPORT SERIES its modern look and great light performance. The combination of Flood and Spot reflectors creates a far and wide illumination for maximum visibility at night. 1 year warranty

Voltage	10-30 VDC
Light pattern:	Combo Beam
Light source:	LED
Power consumption:	180 Watt
Color temperature:	6000 Kelvin
Housing material:	Aluminum
Connection:	Wire leads
Mounting:	Stainless steel bracket
Dimensions	32.2" x 3.0" x 3.4" / 812 x 76 x 86 mm (WxHxD)
Approvals:	IP67
Part Number	357208201 Combo beam

96 LED SPORT SERIES - 50"



9500 lm

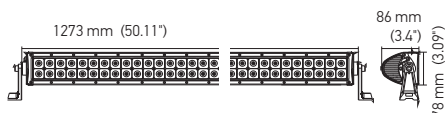

The double row reflector gives this SPORT SERIES its modern look and great light performance. The combination of Flood and Spot reflectors creates a far and wide illumination for maximum visibility at night. 1 year warranty

Voltage	10-30 VDC
Light pattern:	Combo Beam
Light source:	LED
Power consumption:	288 Watt
Color temperature:	6000 Kelvin
Housing material:	Aluminum
Connection:	Wire leads
Mounting:	Stainless steel bracket
Dimensions	50.1" x 3.1" x 3.4" / 1270 x 78 x 86 mm (WxHxD)
Approvals:	IP67
Part Number	357208301 Combo beam

HELLA VALUEFIT DESIGN SERIES

- 1 Combo Beam.** A combination of a spot beam and flood beam
- 2 Diecast Aluminum Housing** able to withstand the elements.
- 3 Aluminum Alloy Brackets** for sturdy upright mounting. A perfect fit for roof, grille and bumper mounting.
- 4 Sleek low profile design** for a discreet lighting solution!



Color Temperature

→ Color temperature is close to natural daylight.
Drivers operating in such lighting conditions
stay alert longer.

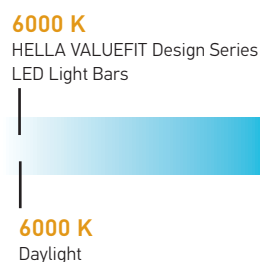

Product image /
Dimensions

Features

6 LED DESIGN SERIES - 11"



3000 lm

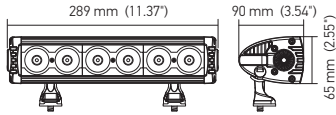

The round reflectors give the DESIGN SERIES the unique appearance. The combination of Flood and Spot reflectors creates a far and wide illumination for maximum visibility at night. 1 year warranty

Voltage	10-30 VDC
Light pattern:	Combo Beam
Light source:	LED
Power consumption:	60 Watt
Color temperature:	6000 Kelvin
Housing material:	Aluminum
Connection:	Wire leads
Mounting:	Stainless steel bracket
Dimensions	11.4" x 2.6" x 3.5" / 289 x 65 x 90 mm (WxHxD)
Approvals:	IP67
Part Number	357209001 Combo beam

12 LED DESIGN SERIES - 21"



5500 lm

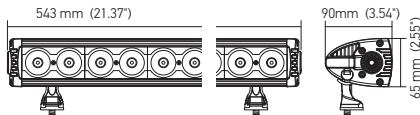

The round reflectors give the DESIGN SERIES the unique appearance. The combination of Flood and Spot reflectors creates a far and wide illumination for maximum visibility at night. 1 year warranty

Voltage	10-30 VDC
Light pattern:	Combo Beam
Light source:	LED
Power consumption:	180 Watt
Color temperature:	6000 Kelvin
Housing material:	Aluminum
Connection:	Wire leads
Mounting:	Stainless steel bracket
Dimensions	21.4" x 2.6" x 3.5" / 543 x 65 x 90 mm (WxHxD)
Approvals:	IP67
Part Number	357209101

18 LED DESIGN SERIES - 31"



8500 lm

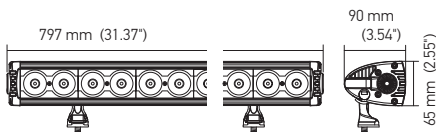

The round reflectors give the DESIGN SERIES the unique appearance. The combination of Flood and Spot reflectors creates a far and wide illumination for maximum visibility at night. 1 year warranty

Voltage	10-30 VDC
Light pattern:	Combo Beam
Light source:	LED
Power consumption:	180 Watt
Color temperature:	6000 Kelvin
Housing material:	Aluminum
Connection:	Wire leads
Mounting:	Stainless steel bracket
Dimensions	31.4" x 2.6" x 3.5" / 797 x 65 x 90 mm (WxHxD)
Approvals:	IP67
Part Number	357209201

30 LED DESIGN SERIES - 51"



14500 lm

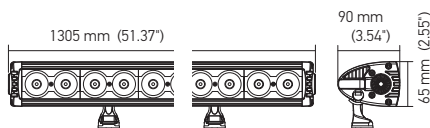

The round reflectors give the DESIGN SERIES the unique appearance. The combination of Flood and Spot reflectors creates a far and wide illumination for maximum visibility at night. 1 year warranty

Voltage	10-30 VDC
Light pattern:	Combo Beam
Light source:	LED
Power consumption:	300 Watt
Color temperature:	6000 Kelvin
Housing material:	Aluminum
Connection:	Wire leads
Mounting:	Stainless steel bracket
Dimensions	51.4" x 2.6" x 3.5" / 1305 x 65 x 90 mm (WxHxD)
Approvals:	IP67
Part Number	357209301

HELLA VALUEFIT PRO SERIES

- 1 Combo Beam.** A combination of a spot beam and flood beam
- 2 Diecast Aluminum Housing** able to withstand the elements.
- 3 Aluminum Alloy Brackets** for sturdy upright mounting. A perfect fit for roof, grille and bumper mounting.
- 4** An all around professional LED light bar, a perfect fit for your next race to out shine the competition!



Color Temperature

- Color temperature is close to natural daylight.
- Drivers operating in such lighting conditions stay alert longer.

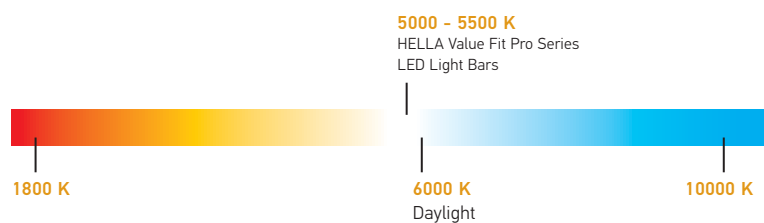

Product image / Dimensions	Features
----------------------------	----------

20 LED PRO SERIES - 12"

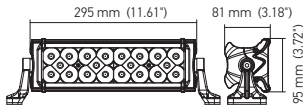

3100 lm

The powerful PRO SERIES comes with a double row reflector and state-of-the-art LED technology. Powerful LEDs provide perfect visibility at night. 1 year warranty

Voltage	10-30 VDC
Light pattern:	Spot Beam
Light source:	LED
Power consumption:	60 Watt
Color temperature:	5500 Kelvin
Housing material:	Aluminum
Connection:	Wire leads
Mounting:	Stainless steel bracket
Dimensions	11.6" x 3.7" x 3.2" / 285 x 96 x 81 mm (WxHxD)
Approvals:	IP67
Part Number	357210001

40 LED PRO SERIES - 21"

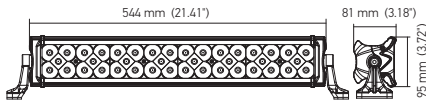

5500 lm

The powerful PRO SERIES comes with a double row reflector and state-of-the-art LED technology. The combination of Flood and Spot reflectors creates a far and wide illumination for maximum visibility at night. 1 year warranty

Voltage	10-30 VDC
Light pattern:	Combo Beam
Light source:	LED
Power consumption:	120 Watt
Color temperature:	5500 Kelvin
Housing material:	Aluminum
Connection:	Wire leads
Mounting:	Stainless steel bracket
Dimensions	21.4" x 3.7" x 3.2" / 544 x 96 x 81 mm (WxHxD)
Approvals:	IP67
Part Number	357210101

60 LED PRO SERIES - 31"

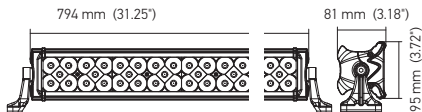

9250 lm

The powerful PRO SERIES comes with a double row reflector and state-of-the-art LED technology. The combination of Flood and Spot reflectors creates a far and wide illumination for maximum visibility at night. 1 year warranty

Voltage	10-30 VDC
Light pattern:	Combo Beam
Light source:	LED
Power consumption:	180 Watt
Color temperature:	5500 Kelvin
Housing material:	Aluminum
Connection:	Wire leads
Mounting:	Stainless steel bracket
Dimensions	31.3" x 3.7" x 3.2" / 794 x 96 x 81 mm (WxHxD)
Approvals:	IP67
Part Number	357210201

100 LED PRO SERIES - 51"

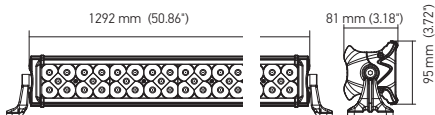

15500 lm

The powerful PRO SERIES comes with a double row reflector and state-of-the-art LED technology. The combination of Flood and Spot reflectors creates a far and wide illumination for maximum visibility at night. 1 year warranty

Voltage	10-30 VDC
Light pattern:	Combo Beam
Light source:	LED
Power consumption:	300 Watt
Color temperature:	5500 Kelvin
Housing material:	Aluminum
Connection:	Wire leads
Mounting:	Stainless steel bracket
Dimensions	50.9" x 3.7" x 3.2" / 1292 x 96 x 81 mm (WxHxD)
Approvals:	IP67
Part Number	357210301

HELLA VALUEFIT WORKLIGHTS







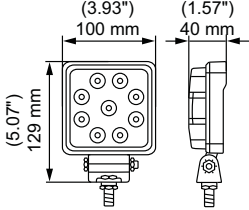

3rd Generation

Check out our new high performance worklights with unique features, innovative technology and very powerful light output.

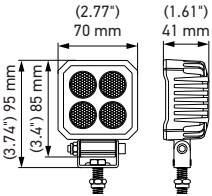

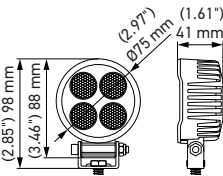
NEW

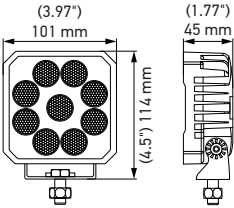
HELLA VALUEFIT WORK LIGHTS

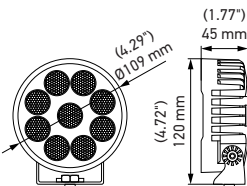
Product image / Dimensions	Features																		
<p>PS1000 LED</p>  <p>1000 lm</p>	<p>LED</p>  <p>Latest LED technology. Thin plastic housing for 100% corrosion resistance. Lightweight - high vibration resistance. Black stainless steel mounting hardware. 2 year warranty.</p> <table border="1"> <tr><td>Voltage</td><td>10 – 30 VDC</td></tr> <tr><td>Light output (measured):</td><td>1,000 Lumen</td></tr> <tr><td>Power consumption:</td><td>9 Watt</td></tr> <tr><td>Color temperature:</td><td>6,500 Kelvin</td></tr> <tr><td>Housing material:</td><td>Thermoplastic</td></tr> <tr><td>Connection:</td><td>30" (800mm) cable with open wires</td></tr> <tr><td>Mounting:</td><td>Black stainless steel bracket</td></tr> <tr><td>Approvals:</td><td>CE, ECE-R10, IP67, IP6K9K (withstands high pressure cleaning)</td></tr> <tr><td>Part Number</td><td>357114002 Close Range</td></tr> </table>	Voltage	10 – 30 VDC	Light output (measured):	1,000 Lumen	Power consumption:	9 Watt	Color temperature:	6,500 Kelvin	Housing material:	Thermoplastic	Connection:	30" (800mm) cable with open wires	Mounting:	Black stainless steel bracket	Approvals:	CE, ECE-R10, IP67, IP6K9K (withstands high pressure cleaning)	Part Number	357114002 Close Range
Voltage	10 – 30 VDC																		
Light output (measured):	1,000 Lumen																		
Power consumption:	9 Watt																		
Color temperature:	6,500 Kelvin																		
Housing material:	Thermoplastic																		
Connection:	30" (800mm) cable with open wires																		
Mounting:	Black stainless steel bracket																		
Approvals:	CE, ECE-R10, IP67, IP6K9K (withstands high pressure cleaning)																		
Part Number	357114002 Close Range																		
<p>TS1700 LED</p>  <p>1700 lm</p>	<p>LED</p>  <p>Most powerful LED worklight in this size. Active Thermo Management to prevent overheating and ensures a long lifetime. Under cold working conditions the light output increases for an even better performance. Super compact size - just 3x3". Black stainless steel mounting hardware. 2 year warranty.</p> <table border="1"> <tr><td>Voltage</td><td>10 – 30 VDC</td></tr> <tr><td>Light output (measured):</td><td>1,700 Lumen</td></tr> <tr><td>Power consumption:</td><td>24 Watt</td></tr> <tr><td>Color temperature:</td><td>5,700 Kelvin</td></tr> <tr><td>Housing material:</td><td>Aluminum</td></tr> <tr><td>Connection:</td><td>30" (800mm) cable with open wires</td></tr> <tr><td>Mounting:</td><td>Black stainless steel bracket</td></tr> <tr><td>Approvals:</td><td>CE, ECE-R10, IP67, IP6K9K (withstands high pressure cleaning)</td></tr> <tr><td>Part Number</td><td>357110002 Close Range</td></tr> </table>	Voltage	10 – 30 VDC	Light output (measured):	1,700 Lumen	Power consumption:	24 Watt	Color temperature:	5,700 Kelvin	Housing material:	Aluminum	Connection:	30" (800mm) cable with open wires	Mounting:	Black stainless steel bracket	Approvals:	CE, ECE-R10, IP67, IP6K9K (withstands high pressure cleaning)	Part Number	357110002 Close Range
Voltage	10 – 30 VDC																		
Light output (measured):	1,700 Lumen																		
Power consumption:	24 Watt																		
Color temperature:	5,700 Kelvin																		
Housing material:	Aluminum																		
Connection:	30" (800mm) cable with open wires																		
Mounting:	Black stainless steel bracket																		
Approvals:	CE, ECE-R10, IP67, IP6K9K (withstands high pressure cleaning)																		
Part Number	357110002 Close Range																		
<p>TR1700 LED</p>  <p>1700 lm</p>	<p>LED</p>  <p>Most powerful LED worklight in this size. Active Thermo Management to prevent overheating and ensures a long lifetime. Under cold working conditions the light output increases for an even better performance. Super compact size - just 3x3". Black stainless steel mounting hardware. 2 year warranty.</p> <table border="1"> <tr><td>Voltage</td><td>10 – 30 VDC</td></tr> <tr><td>Light output (measured):</td><td>1,700 Lumen</td></tr> <tr><td>Power consumption:</td><td>24 Watt</td></tr> <tr><td>Color temperature:</td><td>5,700 Kelvin</td></tr> <tr><td>Housing material:</td><td>Aluminum</td></tr> <tr><td>Connection:</td><td>30" (800mm) cable with open wires</td></tr> <tr><td>Mounting:</td><td>Black stainless steel bracket</td></tr> <tr><td>Approvals:</td><td>CE, ECE-R10, IP67, IP6K9K (withstands high pressure cleaning)</td></tr> <tr><td>Part Number</td><td>357111002 Close Range</td></tr> </table>	Voltage	10 – 30 VDC	Light output (measured):	1,700 Lumen	Power consumption:	24 Watt	Color temperature:	5,700 Kelvin	Housing material:	Aluminum	Connection:	30" (800mm) cable with open wires	Mounting:	Black stainless steel bracket	Approvals:	CE, ECE-R10, IP67, IP6K9K (withstands high pressure cleaning)	Part Number	357111002 Close Range
Voltage	10 – 30 VDC																		
Light output (measured):	1,700 Lumen																		
Power consumption:	24 Watt																		
Color temperature:	5,700 Kelvin																		
Housing material:	Aluminum																		
Connection:	30" (800mm) cable with open wires																		
Mounting:	Black stainless steel bracket																		
Approvals:	CE, ECE-R10, IP67, IP6K9K (withstands high pressure cleaning)																		
Part Number	357111002 Close Range																		
<p>TS3000 LED</p>  <p>3000 lm</p>	<p>LED</p>  <p>Most powerful HELLA ValueFit worklight. Active Thermo Management to prevent overheating. Under cold working conditions the light output increases for an even better performance (up to 4,000 lm). Heavy Duty bracket for high impact resistance. Black stainless steel mounting hardware. 2 year warranty.</p> <table border="1"> <tr><td>Voltage</td><td>10 – 30 VDC</td></tr> <tr><td>Light output (measured):</td><td>3,000 Lumen</td></tr> <tr><td>Power consumption:</td><td>31 Watt</td></tr> <tr><td>Color temperature:</td><td>5,700 Kelvin</td></tr> <tr><td>Housing material:</td><td>Aluminum</td></tr> <tr><td>Connection:</td><td>30" (800mm) cable with open wires</td></tr> <tr><td>Mounting:</td><td>Black stainless steel bracket</td></tr> <tr><td>Approvals:</td><td>CE, ECE-R10, IP67, IP6K9K (withstands high pressure cleaning)</td></tr> <tr><td>Part Number</td><td>357112002 Close Range</td></tr> </table>	Voltage	10 – 30 VDC	Light output (measured):	3,000 Lumen	Power consumption:	31 Watt	Color temperature:	5,700 Kelvin	Housing material:	Aluminum	Connection:	30" (800mm) cable with open wires	Mounting:	Black stainless steel bracket	Approvals:	CE, ECE-R10, IP67, IP6K9K (withstands high pressure cleaning)	Part Number	357112002 Close Range
Voltage	10 – 30 VDC																		
Light output (measured):	3,000 Lumen																		
Power consumption:	31 Watt																		
Color temperature:	5,700 Kelvin																		
Housing material:	Aluminum																		
Connection:	30" (800mm) cable with open wires																		
Mounting:	Black stainless steel bracket																		
Approvals:	CE, ECE-R10, IP67, IP6K9K (withstands high pressure cleaning)																		
Part Number	357112002 Close Range																		
<p>TR3000 LED</p>  <p>3000 lm</p>	<p>LED</p>  <p>Most powerful HELLA ValueFit worklight. Active Thermo Management to prevent overheating. Under cold working conditions the light output increases for an even better performance (up to 4,000 lm). Heavy Duty bracket for high impact resistance. Black stainless steel mounting hardware. 2 year warranty.</p> <table border="1"> <tr><td>Voltage</td><td>10 – 30 VDC</td></tr> <tr><td>Light output (measured):</td><td>3,000 Lumen</td></tr> <tr><td>Power consumption:</td><td>31 Watt</td></tr> <tr><td>Color temperature:</td><td>5,700 Kelvin</td></tr> <tr><td>Housing material:</td><td>Aluminum with black stainless steel mounting bracket</td></tr> <tr><td>Connection:</td><td>30" (800mm) cable with open wire leads</td></tr> <tr><td>Approvals:</td><td>CE, ECE-R10, IP67, IP6K9K (withstands high pressure cleaning)</td></tr> <tr><td>Part Number</td><td>357113002 Close Range</td></tr> </table>	Voltage	10 – 30 VDC	Light output (measured):	3,000 Lumen	Power consumption:	31 Watt	Color temperature:	5,700 Kelvin	Housing material:	Aluminum with black stainless steel mounting bracket	Connection:	30" (800mm) cable with open wire leads	Approvals:	CE, ECE-R10, IP67, IP6K9K (withstands high pressure cleaning)	Part Number	357113002 Close Range		
Voltage	10 – 30 VDC																		
Light output (measured):	3,000 Lumen																		
Power consumption:	31 Watt																		
Color temperature:	5,700 Kelvin																		
Housing material:	Aluminum with black stainless steel mounting bracket																		
Connection:	30" (800mm) cable with open wire leads																		
Approvals:	CE, ECE-R10, IP67, IP6K9K (withstands high pressure cleaning)																		
Part Number	357113002 Close Range																		

HELLA VALUEFIT PRODUCT RANGE

Product image / Dimensions	Features
----------------------------	----------

S3000 LED

LED



3000 lm

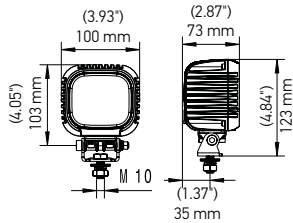

Perfect close range illumination to generate daylight working conditions at night. Designed for applications at the highest lighting requirements. Powerful compact LED worklight - 1 light can replace up to 3 halogen worklights. Integrated DT connector for safe and perfectly sealed electrical connection. 2 year warranty.

Voltage	10 – 52 VDC
Light output (measured):	3,000 Lumen
Power consumption:	31 Watt
Color temperature:	6000 Kelvin / 2500 Kelvin amber version
Housing material:	Aluminum
Connection:	Integrated DT Connector + 30" (800mm) adapter cable with open wire leads
Mounting:	Stainless steel bracket
Approvals:	CE, ECE-R10, RoHS, IP67, IP6K9K (withstands high pressure cleaning)
Part Number	357109002 Close Range 357109022 Close Range, amber

5RD LED 2.0

LED



2000 lm

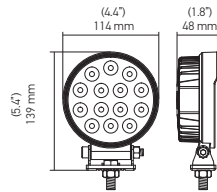

Powerful LED worklight. Flat and compact design. Also available in amber for winter or foggy environments. Stainless steel mounting hardware. 1 year warranty.

Voltage	10 - 30 VDC
Light output (measured):	2000 Lumen / 1700 Lumen amber version
Power consumption:	24 Watt
Color temperature:	6000 Kelvin / 2500 Kelvin amber version
Housing material:	Aluminum
Connection:	20" (500mm) cable with open wires
Mounting:	Stainless steel bracket
Approvals:	CE, ECE-R10, IP67, IP6K9K (withstands high pressure cleaning)
Part Number	357105002 Close Range 357105012 Long Range 358115371 (357106012AMB) Close Range, amber

5RD LED 1.0

LED



1000 lm

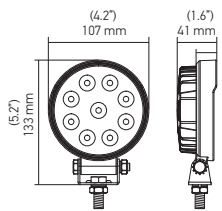

Favorite LED worklight in size and shape. Flat and round design (4" diameter). Stainless steel mounting hardware. 1 year warranty.

Voltage	10 - 30 VDC
Light output (measured):	1000 Lumen
Power consumption:	15 Watt
Color temperature:	6000 Kelvin
Housing material:	Aluminum
Connection:	20" (500mm) cable with open wires
Mounting:	Stainless steel bracket
Approvals:	CE, ECE-R10, IP67, IP6K9K (withstands high pressure cleaning)
Part Number	357101002 Close Range 357100002 Long Range

5RD LED

LED



700 lm

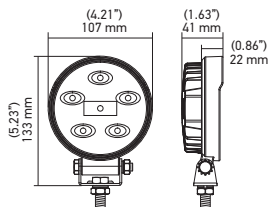



Perfect entry level worklight for a switch from halogen to LED. Flat and square design (4x4"), Stainless steel mounting hardware. 1 year warranty.

Voltage	10 - 30 VDC
Light output (measured):	700 Lumen
Power consumption:	9 Watt
Color temperature:	6000 Kelvin
Housing material:	Aluminum
Connection:	20" (500mm) cable with open wires
Mounting:	Stainless steel bracket
Approvals:	CE, ECE-R10, IP67, IP6K9K (withstands high pressure cleaning)
Part Number	357108001 Close Range

HELLA VALUEFIT

WORK LIGHTS

Product image / Dimensions	Features																								
<p>4SQ LED 2.0</p>  <p>2000 lm</p>	<p>Powerful LED worklight in suitable size. Also available with a magnet, switch and handle Stainless steel mounting hardware. 1 year warranty.</p> <table border="1"> <tr><td>Voltage</td><td>10 - 30 VDC</td></tr> <tr><td>Light output (measured):</td><td>2000 Lumen</td></tr> <tr><td>Power consumption:</td><td>24 Watt</td></tr> <tr><td>Color temperature:</td><td>6000 Kelvin</td></tr> <tr><td>Housing material:</td><td>Aluminum</td></tr> <tr><td>Connection:</td><td>20" (500mm) cable with open wires</td></tr> <tr><td>Mounting:</td><td>Stainless steel bracket</td></tr> <tr><td>Approvals:</td><td>CE, ECE-R10, IP67, IP6K9K (withstands high pressure cleaning)</td></tr> </table> <p>Part Number</p> <table border="1"> <tr><td>357106002</td><td>Close Range</td></tr> <tr><td>357106012</td><td>Long Range</td></tr> <tr><td>357103061</td><td>Close Range, Handle + Switch, Magnet</td></tr> <tr><td>357103071</td><td>Long Range, Handle + Switch, Magnet</td></tr> </table>	Voltage	10 - 30 VDC	Light output (measured):	2000 Lumen	Power consumption:	24 Watt	Color temperature:	6000 Kelvin	Housing material:	Aluminum	Connection:	20" (500mm) cable with open wires	Mounting:	Stainless steel bracket	Approvals:	CE, ECE-R10, IP67, IP6K9K (withstands high pressure cleaning)	357106002	Close Range	357106012	Long Range	357103061	Close Range, Handle + Switch, Magnet	357103071	Long Range, Handle + Switch, Magnet
Voltage	10 - 30 VDC																								
Light output (measured):	2000 Lumen																								
Power consumption:	24 Watt																								
Color temperature:	6000 Kelvin																								
Housing material:	Aluminum																								
Connection:	20" (500mm) cable with open wires																								
Mounting:	Stainless steel bracket																								
Approvals:	CE, ECE-R10, IP67, IP6K9K (withstands high pressure cleaning)																								
357106002	Close Range																								
357106012	Long Range																								
357103061	Close Range, Handle + Switch, Magnet																								
357103071	Long Range, Handle + Switch, Magnet																								

<p>4SQ LED 1.0</p>  <p>1000 lm</p>	<p>Favorite LED worklight in size and shape. Flat and square design (4x4") Also available with a handle and switch. Stainless steel mounting hardware. 1 year warranty.</p> <table border="1"> <tr><td>Voltage</td><td>10 - 30 VDC</td></tr> <tr><td>Light output (measured):</td><td>1000 Lumen</td></tr> <tr><td>Power consumption:</td><td>15 Watt</td></tr> <tr><td>Color temperature:</td><td>6000 Kelvin</td></tr> <tr><td>Housing material:</td><td>Aluminum</td></tr> <tr><td>Connection:</td><td>20" (500mm) cable with open wires</td></tr> <tr><td>Mounting:</td><td>Stainless steel bracket</td></tr> <tr><td>Approvals:</td><td>CE, ECE-R10, IP67, IP6K9K (withstands high pressure cleaning)</td></tr> </table> <p>Part Number</p> <table border="1"> <tr><td>357103002</td><td>Close Range</td></tr> <tr><td>357102002</td><td>Long Range</td></tr> <tr><td>357103041</td><td>Close Range, Handle + Switch , DT connector</td></tr> <tr><td>357103051</td><td>Long Range, Handle + Switch , DT connector</td></tr> </table>	Voltage	10 - 30 VDC	Light output (measured):	1000 Lumen	Power consumption:	15 Watt	Color temperature:	6000 Kelvin	Housing material:	Aluminum	Connection:	20" (500mm) cable with open wires	Mounting:	Stainless steel bracket	Approvals:	CE, ECE-R10, IP67, IP6K9K (withstands high pressure cleaning)	357103002	Close Range	357102002	Long Range	357103041	Close Range, Handle + Switch , DT connector	357103051	Long Range, Handle + Switch , DT connector
Voltage	10 - 30 VDC																								
Light output (measured):	1000 Lumen																								
Power consumption:	15 Watt																								
Color temperature:	6000 Kelvin																								
Housing material:	Aluminum																								
Connection:	20" (500mm) cable with open wires																								
Mounting:	Stainless steel bracket																								
Approvals:	CE, ECE-R10, IP67, IP6K9K (withstands high pressure cleaning)																								
357103002	Close Range																								
357102002	Long Range																								
357103041	Close Range, Handle + Switch , DT connector																								
357103051	Long Range, Handle + Switch , DT connector																								

<p>4SQ LED</p>  <p>700 lm</p>	<p>Perfect entry level worklight for a switch from halogen to LED. Flat and square design (4x4"). Stainless steel mounting hardware. 1 year warranty.</p> <table border="1"> <tr><td>Voltage</td><td>10 - 30 VDC</td></tr> <tr><td>Light output (measured):</td><td>700 Lumen</td></tr> <tr><td>Power consumption:</td><td>9 Watt</td></tr> <tr><td>Color temperature:</td><td>6000 Kelvin</td></tr> <tr><td>Housing material:</td><td>Aluminum</td></tr> <tr><td>Connection:</td><td>20" (500mm) cable with open wires</td></tr> <tr><td>Mounting:</td><td>Stainless steel bracket</td></tr> <tr><td>Approvals:</td><td>CE, ECE-R10, IP67, IP6K9K (withstands high pressure cleaning)</td></tr> </table> <p>Part Number</p> <table border="1"> <tr><td>357107001</td><td>Close Range</td></tr> </table>	Voltage	10 - 30 VDC	Light output (measured):	700 Lumen	Power consumption:	9 Watt	Color temperature:	6000 Kelvin	Housing material:	Aluminum	Connection:	20" (500mm) cable with open wires	Mounting:	Stainless steel bracket	Approvals:	CE, ECE-R10, IP67, IP6K9K (withstands high pressure cleaning)	357107001	Close Range
Voltage	10 - 30 VDC																		
Light output (measured):	700 Lumen																		
Power consumption:	9 Watt																		
Color temperature:	6000 Kelvin																		
Housing material:	Aluminum																		
Connection:	20" (500mm) cable with open wires																		
Mounting:	Stainless steel bracket																		
Approvals:	CE, ECE-R10, IP67, IP6K9K (withstands high pressure cleaning)																		
357107001	Close Range																		

<p>RC 360 GEN. 2</p>  <p>3250 lm</p>	<p>Remote controlled LED searchlight Vertical rotation: 110 degree, horizontal rotation: 360 degree Flash function: SOS Distress Signal (3 long flash - 2 short flash) Remote control and batteries included 1 year warranty</p> <table border="1"> <tr><td>Voltage</td><td>10 - 30 VDC</td></tr> <tr><td>Light output (measured):</td><td>3250 Lumen</td></tr> <tr><td>Power consumption:</td><td>80 Watt</td></tr> <tr><td>Color temperature:</td><td>6500 Kelvin</td></tr> <tr><td>Housing material:</td><td>Aluminum</td></tr> <tr><td>Connection:</td><td>15 ft cable with cigarette lighter plug</td></tr> <tr><td>Mounting:</td><td>Magnet or fixed mounting (upright only)</td></tr> <tr><td>Approvals:</td><td>IP67</td></tr> </table> <p>Part Number</p> <table border="1"> <tr><td>357104041</td><td>Spot light, Black housing</td></tr> <tr><td>357104051</td><td>Spot light, White housing</td></tr> </table>	Voltage	10 - 30 VDC	Light output (measured):	3250 Lumen	Power consumption:	80 Watt	Color temperature:	6500 Kelvin	Housing material:	Aluminum	Connection:	15 ft cable with cigarette lighter plug	Mounting:	Magnet or fixed mounting (upright only)	Approvals:	IP67	357104041	Spot light, Black housing	357104051	Spot light, White housing
Voltage	10 - 30 VDC																				
Light output (measured):	3250 Lumen																				
Power consumption:	80 Watt																				
Color temperature:	6500 Kelvin																				
Housing material:	Aluminum																				
Connection:	15 ft cable with cigarette lighter plug																				
Mounting:	Magnet or fixed mounting (upright only)																				
Approvals:	IP67																				
357104041	Spot light, Black housing																				
357104051	Spot light, White housing																				

HELLA VALUEFIT PRODUCT RANGE

Product image / Dimensions	Features
----------------------------	----------

2 LED BLUE



300 lm

LED



Great optical warning effect to increase work safety. Provides visual blue warning signal for pedestrians. 2 LEDs project the blue light beam spot within 3-5 meters in front of the vehicle. Designed for forklifts. 1 year warranty.

Voltage	10 - 80 VDC
Light output (measured):	300 Lumen
Power consumption:	6 Watt
Color temperature:	9000 Kelvin
Housing material:	Aluminum
Connection:	20" (500mm) cable with open wires
Mounting:	Stainless steel bracket
Approvals:	CE, ECE-R10, IP67, IP6K9K (withstands high pressure cleaning)
Part Number	530040329 (H71030181) Warning Spot, Blue

SL60 LED



LED

- Super compact LED warning stripe to improve the safety at work
- Projection: Blue or red stripe-shaped warning line to the ground
- Powerful light output for visibility even under daylight conditions
- Compact design is well-suited when little installation space is available
- 2 year warranty

- Voltage: 10-80 VDC
- Power Consumption: max. 7 Watt
- Colors: Blue, Red
- Housing Material: Aluminum
- Connection: 20 " cable with open wires
- Mounting: Stainless Steel Bracket
- Approvals: CE, ECE-R10, IP6K9K (withstands high pressure cleaning)

996210001 Blue

996210011 Red

Contains:

- 1 LED Light
- Mounting instructions and installation components

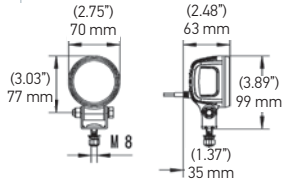

Product image / Dimensions	Features
----------------------------	----------

WIRE HARNESS FOR SINGLE LIGHT



Perfect for HELLA ValueFit auxiliary lights and lightbars
For single light - up to 300W of power
Relay, switch and fuse included

Voltage:	12 VDC
Power:	Up to 300 W
Connection:	ATP Connector
Contains:	1 x 10 ft cable, 1 x 18" fuse cable, 1 x 6.4 ft switch cable
Part Number	357211001

WIRE HARNESS FOR TWO LIGHTS



Wire Harness for Two Lights

Perfect for HELLA ValueFit auxiliary lights and lightbars
For two lights - up to 300 W of power
Relay, switch and fuse included

Voltage:	12 VDC
Power:	Up to 300 W
Connection:	DT Connectors
Contains:	2 x 10 ft cable, 1 x 18" fuse cable, 1 x 6.4 ft switch cable
Part Number	357211011

DISPLAYS:

Product displays are the number one sales tool to highlight new products and get the immediate attention of the customers. Having a well designed product displays helps to explain the products and will have a positive effect on the sales success. Our displays are fully assembled, completely wired, using high quality On/Off switches and a 110 V power supply.

HELLA VALUEFIT AUXILIARY LIGHT DISPLAY



Products	(1) HELLA VALUEFIT 450 LED (1) HELLA VALUEFIT 500 LED and amber stone shield
Dimensions	20" x 4" x 5.9" / 510 x 102 x 150 mm (WxHxD)
Part Number	358117201

HELLA VALUEFIT WORKLIGHT DISPLAY



Content	(1) HELLA VALUEFIT PS1000 (1) HELLA VALUEFIT TR1700 (1) HELLA VALUEFIT TS3000
Dimensions	17.7" x 4.7" x 6.3" / 450 x 120 x 160 mm (WxHxD)
N° de Parte	999942107

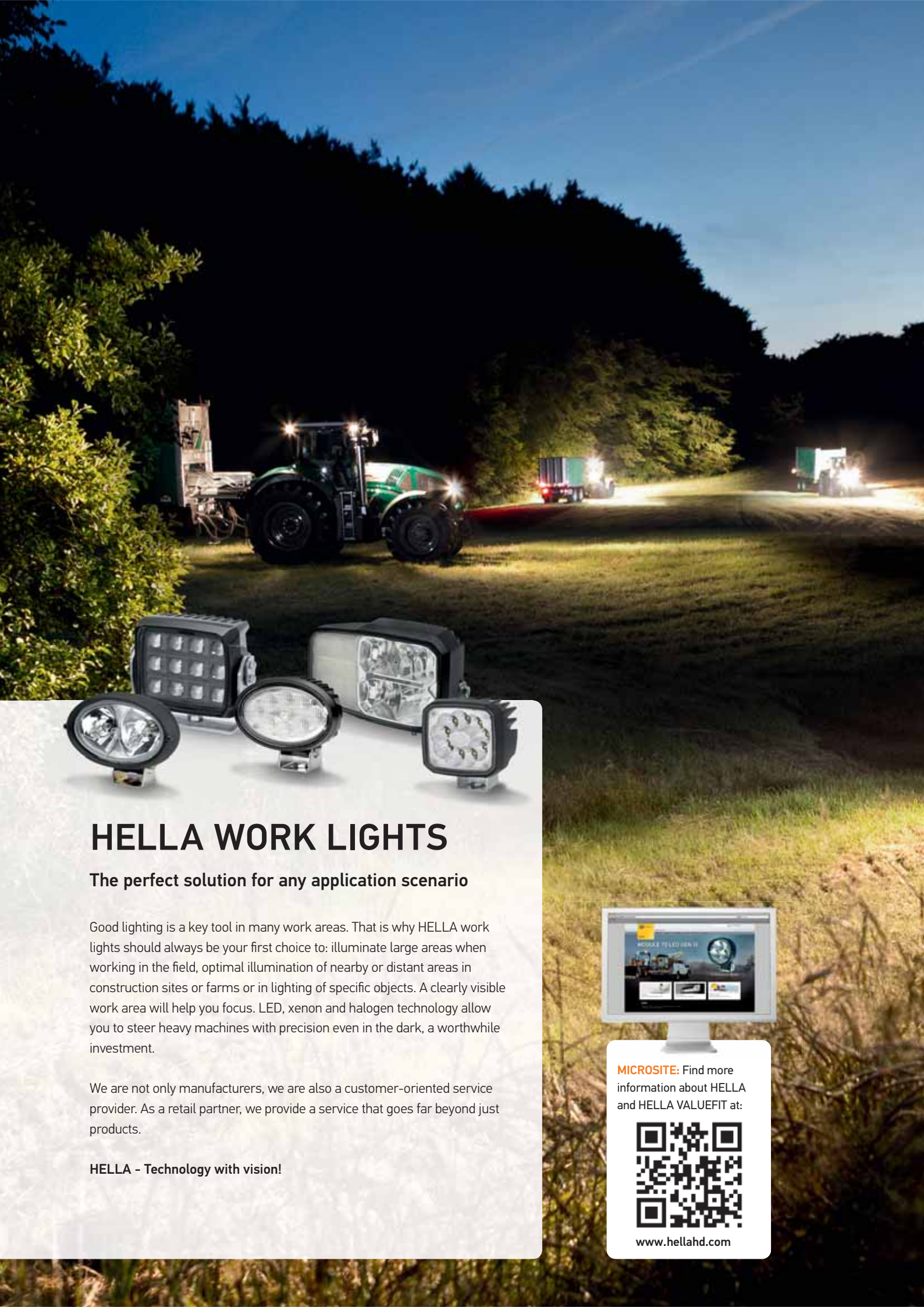

HELLA WORK LIGHTS

The perfect solution for any application scenario

Good lighting is a key tool in many work areas. That is why HELLA work lights should always be your first choice to: illuminate large areas when working in the field, optimal illumination of nearby or distant areas in construction sites or farms or in lighting of specific objects. A clearly visible work area will help you focus. LED, xenon and halogen technology allow you to steer heavy machines with precision even in the dark, a worthwhile investment.

We are not only manufacturers, we are also a customer-oriented service provider. As a retail partner, we provide a service that goes far beyond just products.

HELLA - Technology with vision!



MICROSITE: Find more information about HELLA and HELLA VALUEFIT at:



www.hellahd.com



WORK LIGHTS

PRODUCT RANGE

Product image /
Dimensions

Features

HYPALUME

LED

- Developed specifically for mining and lighting tower applications
- Highly efficient light distribution
- Powerful LEDs illuminate the surrounding area for daylight working conditions
- Close Range, long range and extra wide illumination options
- Different versions from 24 VDC up to 240 VAC available
- Thermal management
- 5 year warranty

Features

- Light output (measured): 28,000 lumen
- Power requirement: 300 Watt
- Color temperature: 5,700 Kelvin
- Housing Material: Aluminum
- Protection: Reverse polarity, transient spike circuit protection
- > 60 VDC over-voltage protection
- Connection: 4 pin DT connector
- Mounting: Heavy Duty Stainless Steel Bracket
- Approvals: RCM, FCC, CE, IP6K7, IP 6K9K (withstands high pressure cleaning)
- Soft Start at PIN3
- 5 Dimming levels at PIN 4
- Non-stick and easy to clean surface coating
- High impact Grilamid nylon lens,
- 50 G Heavy Duty stainless steel bracket
- Mounting standing / hanging.

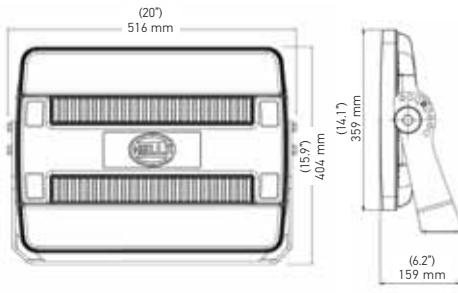

48 V

HypaLUME 48V RFCommSafe

Close Range	011872221
Long Range	011872231*
Extra Wide	011872241*

24-48 V

HypaLUME Multi-voltage 24 - 48 VDC

Close Range	011872501
Long Range	011872511*
Extra Wide	011872521*

Accessories

AC/DC Converter 320 W 24 V	358116681
AC/DC Converter 320 W 48 V	358116171
AC/DC Converter 300 W 480 VAC - 24 VDC	358116701

100-240 V AC

HypaLUME 100-240 V AC

Close Range	958334011
Long Range	958334021*
Extra Wide	958334031*

*Special order item

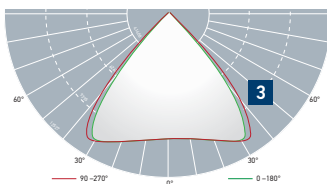
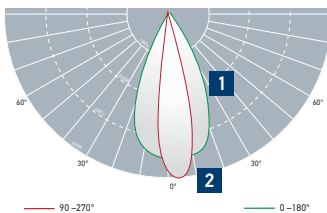

- 1 CR: Close Range
- 2 LR: Long Range
- 3 XW: Extra Wide Flood



ZEROGLARE

Bringing Onroad Safety to Mining

HELLA Mining has developed the **ZEROGLARE** optical system to bring the safety and comfort of highway driving to mining operations! The **ZEROGLARE** optical system ensures no light from oncoming traffic will be directed into the eyes of oncoming drivers eliminating the occurrence of discomfort or disability glare. The innovative optical system has a sharp horizontal cut off to control the light onto the ground in front of the vehicle and not into oncoming operators field of vision.



The **ZEROGLARE** optical system ensures all emitted light is directed below the horizontal plane



With **ZEROGLARE**

Scan for Video on ZEROGLARE



Product image / Dimensions	Features	Technical Specifications	Part Number
----------------------------	----------	--------------------------	-------------

RokLUME 380

LED



8000 lm

- Most powerful LED worklight in the HELLA range
- Designed for the roughest mining conditions
- Heavy Duty bracket for extra strong resistance to vibration
- Aluminum housing is protected with a special NanoSafe (non-sticky and easy to clean surface) coating
- NanoSafe (non-sticky and easy to clean surface) coating
- ZEROGLARE option for non-glare illumination
- DT counterpart included
- 5 year warranty

Contains:

- 1 LED Light, mounting instructions and installation components

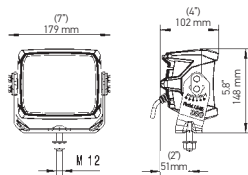

- Voltage: 20-32 VDC
- Light Output (measured): 8,000 lm
- Power Consumption: 84 Watt
- Color Temperature: 5,000 Kelvin
- Housing Material: Aluminum
- Lens Material: Hardcoated PC lens
- Connection: DT connector
- Mounting: Heavy Duty bracket
- Approvals: IP6K8, IP6K9K (withstands high pressure cleaning)

996197001 ZEROGLARE 24 V

996197011 Close Range 24 V

996197021 Longe range 24 V

996197041 Pencil beam 24 V

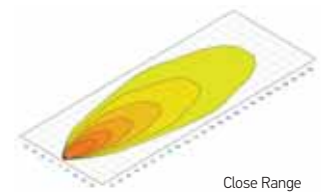
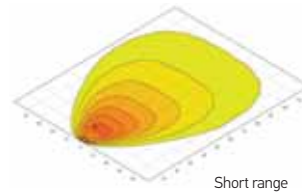

RokLUME 280

LED



4400 lm

- Powerful LED worklight designed for the roughest mining conditions
- Heavy Duty bracket for extra strong resistance to vibration
- Aluminum housing is protected with a special NanoSafe (non-sticky and easy to clean surface) coating
- ZEROGLARE option for non-glare illumination
- DT counterpart included
- 5 year warranty

Contains:

- 1 LED Light
- Mounting instructions and installation components

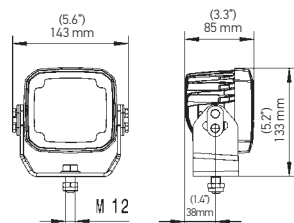

- Voltage: 9-33 VDC
- Light Output (measured): 4,400 lm
- Power Consumption: 55 Watt
- Color Temperature: 5,000 Kelvin
- Housing Material: Aluminum
- Lens Material: Hardcoated PC lens
- Connection: DT connector
- Mounting: Heavy Duty bracket
- Approvals: IP6K8, IP6K9K (withstands high pressure cleaning)

995606541 ZEROGLARE





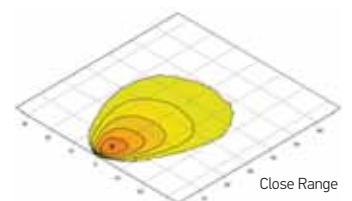

995606501 Close Range



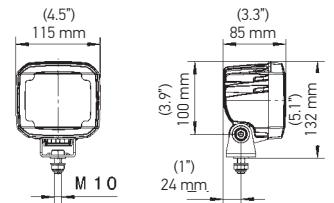
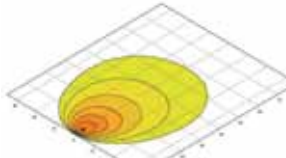
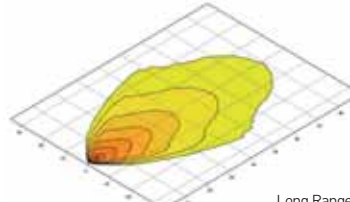

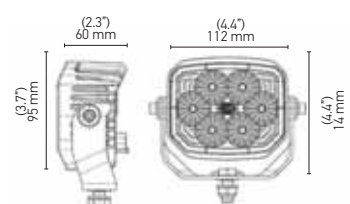
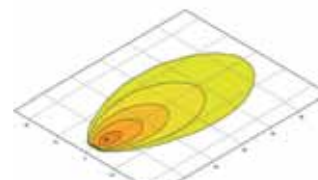
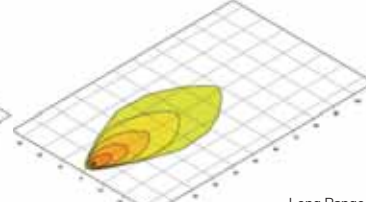

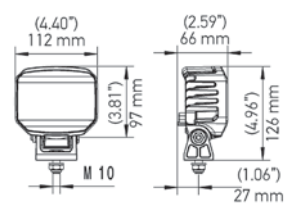
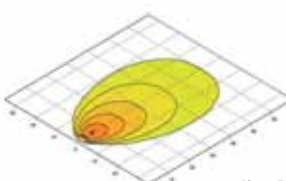
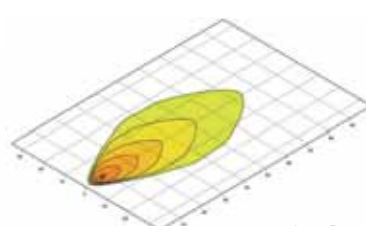
995606521 Pencil beam

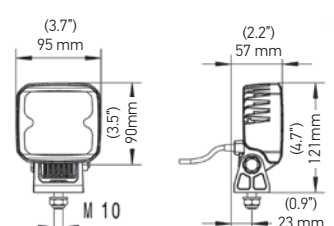
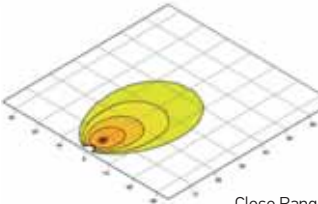
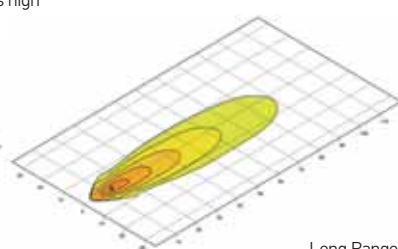

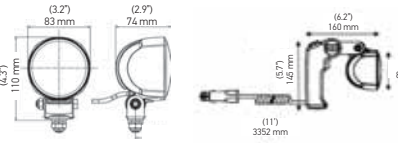
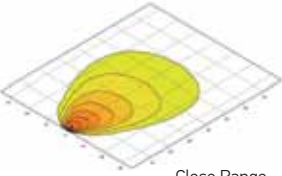
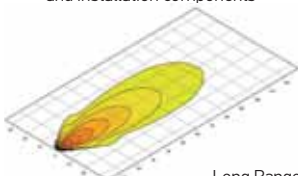
WORK LIGHTS

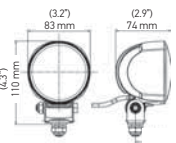
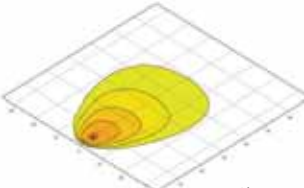
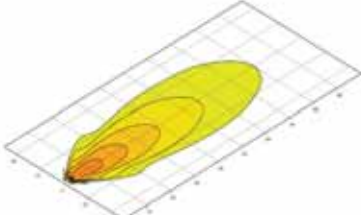

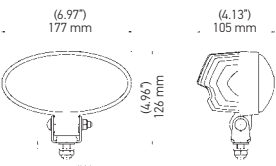
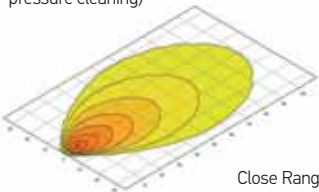
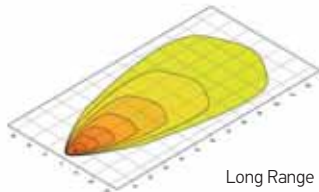

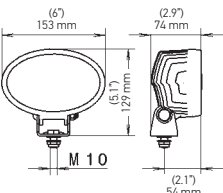
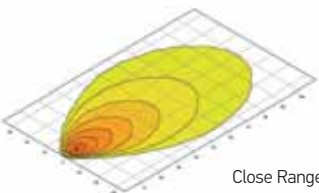
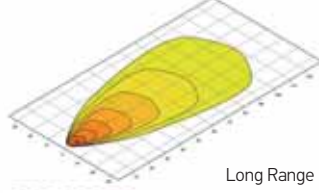

PRODUCT RANGE

Product image / Dimensions	Features	Technical Specifications	Part Number
<p>ULTRA BEAM LED GEN II</p>  <p>4000 lm</p>	<p>LED</p> <ul style="list-style-type: none"> High performance LED worklight for various applications The Ultra Beam LED Gen.2 provides twice as much light as Gen. 1 Available with standard U-bracket or the Heavy Duty surrounding bracket Duty surrounding bracket Thermo Management to secure the perfect LED temperature at all times 2 year warranty 	<ul style="list-style-type: none"> Voltage: 9-33 VDC Light Output (measured): 4,000 lm Power Consumption: 55 Watt Color Temperature: 6,500 Kelvin Housing Material: Aluminum Lens Material: PC Connection: DT connector Mounting: Stainless steel U-bracket / Heavy Duty bracket Approvals: IP6K8, IP6K9K (withstands high pressure cleaning)  	<p>995606001 Close Range</p> <p>995606011 Long Range</p> <p>995606071 Close Range HD bracket</p> <p>995606081 Long Range HD bracket</p> <p>Contains:</p> <ul style="list-style-type: none"> 1 LED Light Mounting instructions and installation components
<p>POWER BEAM 1500 LED</p>  <p>1350 lm</p>	<p>LED</p> <ul style="list-style-type: none"> Compact and robust LED worklight Heavy Duty bracket for strong vibration resistance and 180 degree mounting Plastic cover on the back functions as handle for easy angle adjustments Thermo Management to secure the perfect LED temperature at all times 2 year warranty 	<ul style="list-style-type: none"> Voltage: 9-33 VDC Light Output (measured): 1,350 lm Power Consumption: 22 Watt Color Temperature: 6,500 Kelvin Housing Material: Aluminum Lens Material: PC Connection: DT connector Mounting: Heavy Duty bracket Approvals: IP6K8, IP6K9K (withstands high pressure cleaning)  	<p>996288021 Long Range</p> <p>996288031 Close Range</p> <p>Contains:</p> <ul style="list-style-type: none"> 1 LED Light Mounting instructions and installation components
<p>ROKLUME 190 TP</p>  <p>1850 lm</p>	<p>LED</p> <ul style="list-style-type: none"> Thermo-conductive plastic housing for 100% corrosion resistance Reinforced fiber-glass plastic U-bracket withstands even the hardest impacts Thermo Management to secure the perfect LED temperature at all times Ideal for service pick-up trucks on mine-sites, tow trucks and construction vehicles 2 year warranty 	<ul style="list-style-type: none"> Voltage: 10.5-32 VDC Light Output (measured): 1,850 lm Power Consumption: 26 Watt Color Temperature: 5,000 Kelvin Housing Material: Thermo Plastic Lens Material: PC Connection: DT connector Mounting: Reinforced fibre-glass bracket Approvals: IP6K8, IP6K9K (withstands high pressure cleaning)  	<p>996488501 Close Range</p> <p>996488511 Long Range</p>
<p>ROKLUME 155 TP</p>  <p>1200 lm</p>	<p>LED</p> <ul style="list-style-type: none"> Compact thermo-conductive plastic housing for 100% corrosion resistance Reinforced fiber-glass plastic U-bracket withstands even the hardest impacts Thermo Management to secure the perfect LED temperature at all times Ideal for service pick-up trucks on mine-sites, tow trucks and construction vehicles 2 year warranty 	<ul style="list-style-type: none"> Voltage: 9-33 V Light Output (measured): 1,200 lm Power Consumption: 15 Watt Color Temperature: 5,000 Kelvin Housing Material: Thermo Plastic Lens Material: PC Connection: 12" cable with DT connector Mounting: Reinforced fibre-glass bracket Approvals: IP6K8, IP6K9K (withstands high pressure cleaning)  	<p>996284051 Close Range</p> <p>996284061 Long Range</p> <p>Contains:</p> <ul style="list-style-type: none"> 1 LED Light Mounting instructions

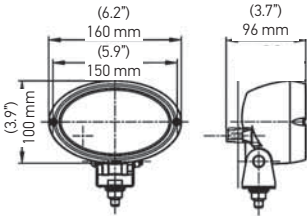
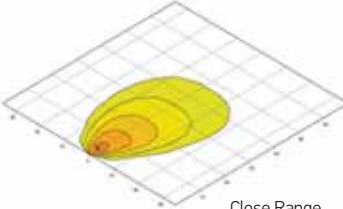
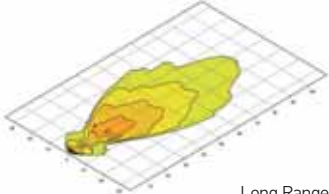
Product image / Dimensions	Features	Technical Specifications	Part Number
<p>MODULE 70 LED GEN 4</p>  <p>2500 lm</p>	<p>LED</p> <ul style="list-style-type: none"> • Most powerful HELLA LED worklight in this round size • 3 Powerful multichip LEDs generate a widespread homogenous light distribution • Thermo Management to secure the perfect LED temperature at all times • LED searchlight comes with handle, switch and spiral cable with lighter plug • 2 year warranty 	<ul style="list-style-type: none"> • Voltage: 9 -33 VDC • Light Output (measured): 2,500 lm • Power Consumption: 30 Watt • Color Temperature: 6,500 Kelvin • Housing Material: Aluminum • Lens material: Glass • Connection: 6.5ft cable with open wires / Searchlight: 11ft spiral cable with lighter plug • Mounting: Stainless steel / handle with switch • Approvals: IP6K8, IP6K9K (withstands high pressure cleaning)  <p>Close Range</p>  <p>Long Range</p>	<p>996476001 Close Range</p> <p>996476011 Long Range</p> <p>996476501* Spot Light Searchlight</p> <p>996476511* Close Range Searchlight</p> <p>*Special order item</p> <p>Contains:</p> <ul style="list-style-type: none"> • 1 LED Light, mounting instructions and installation components
<p>MODUL 70 LED GEN 3.2</p>  <p>1800 lm</p>	<p>LED</p> <ul style="list-style-type: none"> • The new Generation 3.2 provides 2x the light than the old Oval 70 LED Gen. 3 • Compact size perfect for various applications • Homogenous light distribution generates perfect working conditions around your vehicle • Thermo Management to secure the perfect LED temperature at all times • 2 year warranty 	<ul style="list-style-type: none"> • Voltage: 9-33 VDC • Light Output (measured): 1,800 lm • Power Consumption: 20 Watt • Color Temperature: 6,500 Kelvin • Housing Material: Aluminum • Lens Material: Glass • Connection: 6.5ft cable with open wire leads • Mounting: Stainless steel bracket • Approvals: IP6K8, IP6K9K (withstands high pressure cleaning)  <p>Close Range</p>  <p>Long Range</p>	<p>996576031 Close Range</p> <p>996576001 Long Range</p> <p>Contains:</p> <ul style="list-style-type: none"> • 1 LED Light • Mounting instructions and installation components
<p>OVAL 90 LED GEN 2</p>  <p>5000 lm</p>	<p>LED</p> <ul style="list-style-type: none"> • High performance LED worklight for various applications • The Oval 90 LED Gen.2 provides 2x as much light as Gen. 1 • Curved lens provides an extra wide spread illumination to the outer areas • Thermo Management to secure the perfect LED temperature at all times • 2 year warranty 	<ul style="list-style-type: none"> • Voltage: 9-33 VDC • Light Output (measured): 5,000 lm • Power Consumption: 60 Watt • Color Temperature: 6,500 Kelvin • Housing Material: Aluminum • Lens Material: PC • Connection: DT connector • Mounting: Stainless steel bracket • Approvals: IP6K8, IP6K9K (withstands high pressure cleaning)  <p>Close Range</p>  <p>Long Range</p>	<p>996486001 Close Range</p> <p>996486011 Long Range</p> <p>Contains:</p> <ul style="list-style-type: none"> • 1 LED Light • Mounting instructions and installation components
<p>OVAL 100 LED GEN 2</p>  <p>4400 lm</p>	<p>LED</p> <ul style="list-style-type: none"> • High performance LED worklight for various applications • The Oval 100 LED Gen.2 provides 2x as much light as Gen. 1 • Oval design gives the light a very modern look • Thermo Management to secure the perfect LED temperature at all times • 2 year warranty 	<ul style="list-style-type: none"> • Voltage: 9-33 VDC • Light Output (measured): 4,400 lm • Power Consumption: 56 Watt • Color Temperature: 6,500 Kelvin • Housing Material: Aluminum • Lens Material: PC • Connection: DT connector • Mounting: Stainless steel bracket • Approvals: IP6K8, IP6K9K (withstands high pressure cleaning)  <p>Close Range</p>  <p>Long Range</p>	<p>996761001 Close Range</p> <p>996761011 Long Range</p> <p>Contains:</p> <ul style="list-style-type: none"> • 1 LED Light • Mounting instructions and installation components

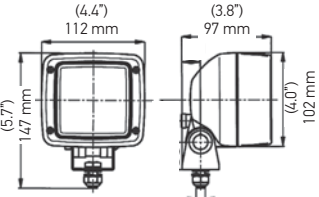
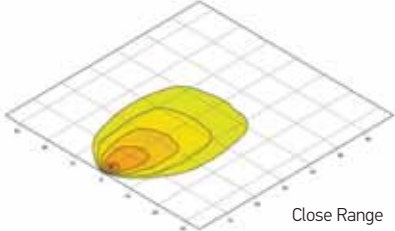
WORK LIGHTS

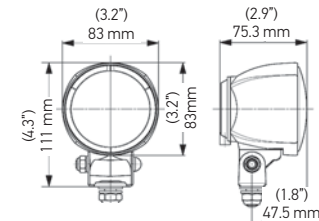
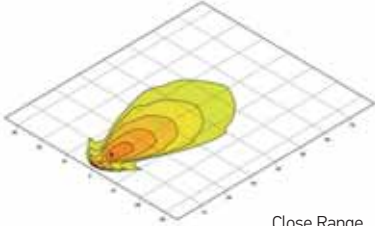
PRODUCT RANGE

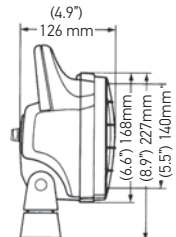
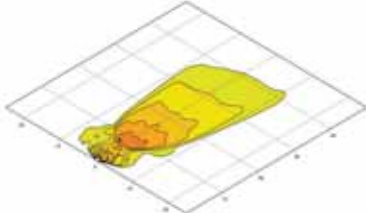
Product image / Dimensions	Features	Technical Specifications	Part Number
<p>OVAL 100 H3</p>  <p>1150 lm</p>	<p>HALOGEN</p> <ul style="list-style-type: none"> • Classic oval halogen worklight • HELLA Free-Form reflector optimizes light distribution • H3 bulb included • 2 year warranty 	<ul style="list-style-type: none"> • Voltage: 12 VDC • Light Output (measured): 1,150 lm / 2,300 lm • Power Consumption: 55 / 110 Watt • Color Temperature: 2,500 Kelvin • Housing Material: HD Plastic • Lens Material: Glass • Connection: 6" cable with open wire leads • Mounting: Stainless Steel bracket • Protection: IP5K9K (pressure cleaner proof)  <p>Close Range</p>  <p>Long Range</p>	<p>996361271 <small>Close Range</small></p> <p>358115061 (H15161031) <small>Long Range 2 X H3</small></p> <p>Contains:</p> <ul style="list-style-type: none"> • 1 Halogen Light • Mounting instructions and installation components
<p>ULTRA BEAM H3</p>  <p>1150 lm</p>	<p>HALOGEN</p> <ul style="list-style-type: none"> • The classic halogen worklight • HELLA Free-Form reflector technology optimizes light distribution • H3 bulb included • 2 year warranty 	<ul style="list-style-type: none"> • Voltage: 12 VDC • Light Output (measured): 1,150 lm • Power Consumption: 55 Watt • Color Temperature: 2,500 Kelvin • Housing Material: HD Plastic • Lens Material: Glass • Connection: AMP connector with 4" cable with open wires • Mounting: Stainless Steel bracket • Protection: IP5K9K (pressure cleaner proof)  <p>Close Range</p>	<p>358115111 (H15506021) <small>Close Range</small></p> <p>Contains:</p> <ul style="list-style-type: none"> • 1 Halogen Light • Mounting instructions and installation components
<p>MODULE 70 H3</p>  <p>1150 lm</p>	<p>HALOGEN</p> <ul style="list-style-type: none"> • Compact halogen worklight for applications with tight mounting options • Easily accessible H3 bulb (included) - no tools required for bulb replacement • Cable feed through an opening in the rubber cap • 2 year warranty 	<ul style="list-style-type: none"> • Voltage: 12 VDC • Light Output (measured): 1,150 lm • Power Consumption: 55 Watt • Color Temperature: 2,500 Kelvin • Housing Material: HD Plastic • Lens Material: Glass • Connection: Cable with open wire leads • Mounting: Stainless Steel bracket • Protection: IP5K9K (pressure cleaner proof)  <p>Close Range</p>	<p>996176491 <small>Close Range Flush mount</small></p> <p>Contains:</p> <ul style="list-style-type: none"> • 1 Halogen Light • Mounting instructions and installation components
<p>MATADOR H3</p>  <p>1150 lm</p>	<p>HALOGEN</p> <ul style="list-style-type: none"> • Halogen worklight with protective grill to protect glass lens from rock chips • 4-point Omega bracket for versatile surface mounting options • Comes with an integrated switch • H3 bulb included • 2 year warranty 	<ul style="list-style-type: none"> • Voltage: 12 VDC / 24 VDC • Light Output (measured): 1,150 lm / 1,300 lm • Power Consumption: 55 Watt / 70 Watt • Color Temperature: 2,500 Kelvin • Housing Material: HD Plastic • Lens Material: Glass • Connection: Cable with open wire leads • Mounting: Stainless Steel bracket • Protection: IP5K9K (pressure cleaner proof) 	<p>358115281 (H15470001) <small>12V Close Range</small></p> <p>003470911 (H15470011) <small>24V Close Range</small></p>

Product image / Dimensions	Features	Technical Specifications	Part Number
----------------------------	----------	--------------------------	-------------

C140 LED HEADLAMPS

LED

- Upgrade your vehicle with HELLA's latest LED snowplow lights
- All four light functions in LED: high beam, low beam, direction indicator and PO light
- Integrated 6-pin DT connector for a sealed and safe connection
- 2 year warranty

- Voltage: 10 - 32 VDC
- Power Consumption: 25 / 40 Watt
- Light Output: Low Beam, High Beam, Indicator, Position
- Color Temperature: 6,000 Kelvin
- Housing Material: Aluminum
- Lens Material: PC
- Connection: 6 pin DT connector
- Mounting: HD stainless steel bracket
- Approvals: ECE, SAE, IP6K9K (withstands high pressure cleaning)

996374011 Left
996374021 Right

- Contains:**
- 1 LED Light
 - Mounting instructions and installation components

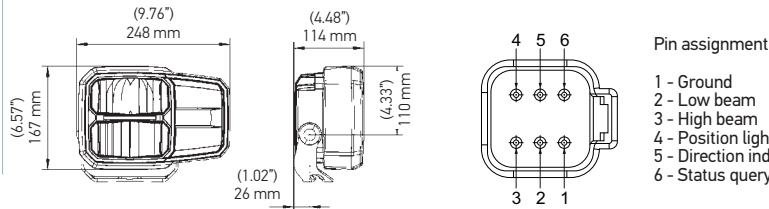

C220 COMBINATION HEADLAMPS

HALOGEN

- Stylish combination headlights / snowplow light
- HELLA Free-Form reflector technology provides superior illumination
- Heavy Duty vibration dampened mounting stud bracket
- 12V bulbs are included
- 2 year warranty

- Voltage: 12 VDC
- Light Output: Low Beam, High Beam, Indicator, Position
- Color Temperature: 2,500 Kelvin
- Housing Material: HD Plastic
- Lens Material: Glass
- Connection: 6 pin DT connector
- Mounting: Heavy Duty stud bracket
- Approvals: ECE, IP5K9K (pressure cleaner proof)
- Light Source: 12 V H7/H3/P21W/T4W

996174251 Left
996174261 Right

- Contains:**
- 1 Halogen Light
 - Mounting instructions and installation components

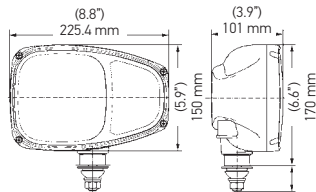

2500 lm

C120 COMBINATION HEADLAMPS

HALOGEN

- Oval shaped combination headlights / snowplow light
- HELLA Free-Form reflector technology provides superior illumination
- Heavy Duty vibration dampened stud mounting bracket
- 12V bulbs are included
- 2 year warranty

- Voltage: 12 VDC
- Light Output: Low Beam, High Beam, Indicator, Position
- Color Temperature: 2,500 Kelvin
- Housing Material: HD Plastic
- Lens Material: Glass
- Connection: 6 pin DT connector
- Mounting: Surface or bracket mount
- Approvals: ECE, SAE, IP5K9K (pressure cleaner proof)
- Light Source: 12 V H7/H3/P21W/T4W

996167051 Left
996167061 Right
996167191 Left, Stud
996167201 Right, Stud

- Contains:**
- 1 Halogen Light
 - Mounting instructions and installation components

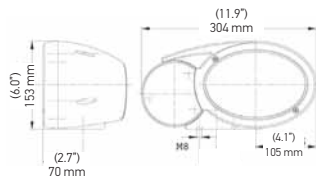

2500 lm

M120 COMBINATION HEADLAMPS

HALOGEN

- Classic square shaped combination headlights / snowplow light
- HELLA Free-Form reflector technology provides superior illumination
- Heavy Duty vibration dampened stud mounting bracket
- 12 V bulbs are included
- 2 year warranty

- Voltage: 12 VDC
- Light Output: Low Beam, High Beam, Indicator, Position
- Color Temperature: 2,500 Kelvin
- Housing Material: HD Plastic
- Lens Material: Glass
- Connection: 6 pin DT connector
- Mounting: Heavy Duty stud bracket
- Approvals: ECE, IP5K9K (pressure cleaner proof)
- Light Source: 12 V H7/H3/P21W/T4W

996120051 12V, Left
996120061 12V, Right

- Contains:**
- 1 Halogen Light
 - Mounting instructions and installation components

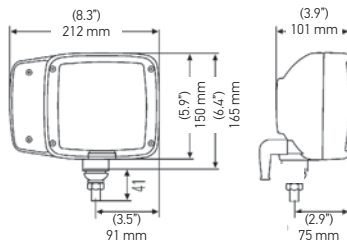

2500 lm

996081277

DISCOVER: NEW!

LIGHT BARS HELLA OWS FULL SIZE!

Available in 48", 56" and 60", as well as
the HELLA MINI LIGHT BAR 10" and 16"





MICROSITE: Find more information at:



www.hellahd.com

OPTICAL WARNING SYSTEMS

The Optical Warning Systems (OWS), the KL series signaling systems, the rotating lamps, beacons and their constant technological implementations make HELLA products so special. Rotating lamps, flashers, warning lights: this is where our specialists combine the best technology with extreme resistance. The result: high-quality LED technology, modern reflector technology, which resists even the toughest weather and working conditions as well as a continuous service without compromising its operation.

HELLA allows you to be absolutely safe and visible at all times.

HELLA FULL SIZE LED LIGHTBAR





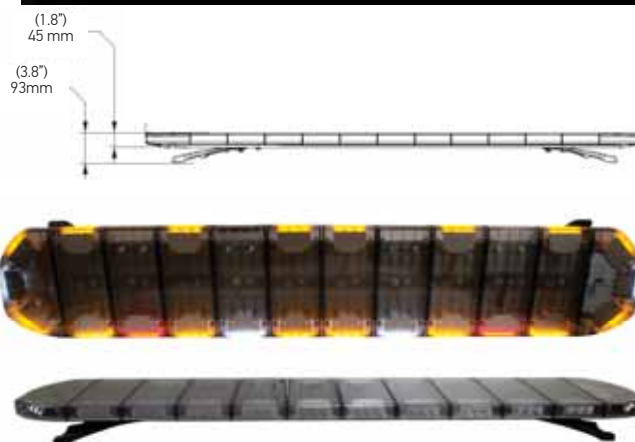





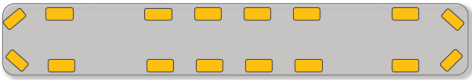
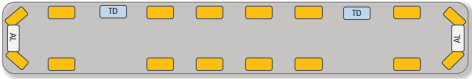
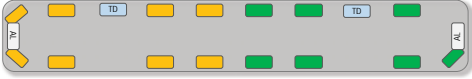

- Choose from 8 different lightbar options varying in sizes to fit your car, truck or light commercial vehicle
- Available in lengths of 48", 56" and 60"
- Stop/Tail/Turn Alley Lights and Take-Down Light options
- Smoked lens design for a stealth look
- All lightbars come with integrated traffic director functionality
- Easy maintenance with top accessibility
- Can be mounted permanently or temporarily using strap kits
- 5 year warranty

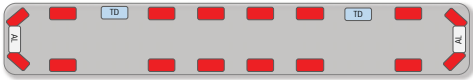
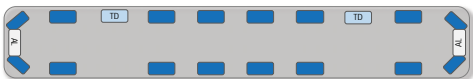
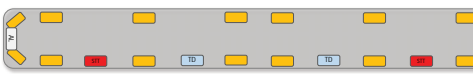

Technical Data	
Voltage:	10-30 VDC
Flash Pattern:	29 user selectable flash pattern
Approvals:	SAE J845 Class 1 , California Title 13
Colors:	Amber, Red, Blue, Green
Power Consumption:	103 / 130 / 143 / 182 Watt
Mounting:	Bracket or vehicle specific strap kits (separate purchase)
Connection:	10ft cable with open wire leads
IP Rating	IP 67

Description	Color	Part Number
LB4800A	● LED Light Bar, 48", Amber	358111781 (H27941001)
LB4800AL	● LED Light Bar, 48", Amber, with takedown and alley lights	358111871 (H27941091)
LB4800AGL	● LED Light Bar, 48", Amber / Green, with takedown and alley lights	358111821* (H27941041)
LB4800RBL	● LED Light Bar, 48", Red / Blue, with takedown and alley lights	358111841* (H27941061)
LB4800RL	● LED Light Bar, 48", Red, with takedown and alley lights	358111851* (H27941071)
LB4800BL	● LED Light Bar, 48", Blue, with takedown and alley lights	358111861* (H27941081)
LB5600AL	● LED Light Bar, 56", Amber, with stop, tail, turn, takedown and alley lights	358111801 (H27941021)
LB6000AL	● LED Light Bar, 60", Amber, with stop, tail, turn, takedown and alley lights	358111811 (H27941031)

* Special order item

<p>358111781</p>  <p>358111871</p>  <p>358111821</p>  <p>358111841</p> 	<p>358111851</p>  <p>358111861</p>  <p>358111801</p>  <p>358111811</p> 	<p>Description</p> <ul style="list-style-type: none"> LED amber module  LED green module  LED red module  LED blue module  Flasher  Takedown light  Alley Lights 
---	---	--

HELLA LED LIGHT BAR STRAP KITS

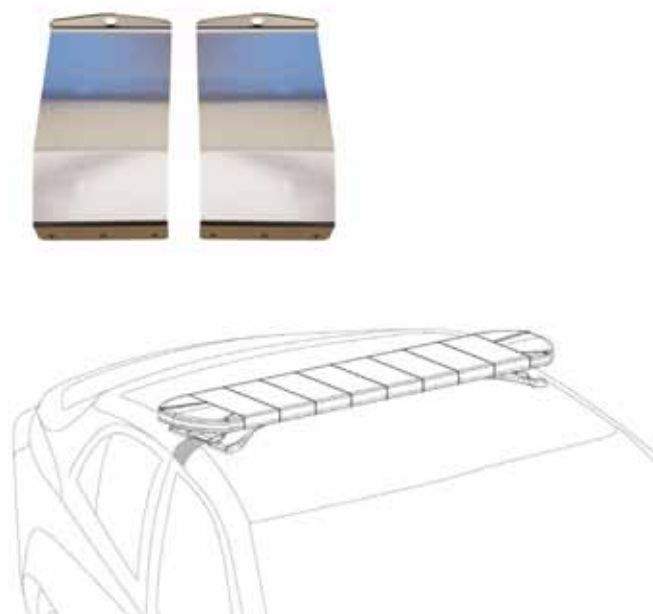

Applications	Years	Part Number
CHEVY IMPALA	2014 - 2015	358115551 (H27942011)
CHEVY SILVERADO	2014 - 2018	358115561 (H27942021)
CHEVY TAHOE	2007 - 2014	358115571 (H27942031)
GMC YUKON	2001 - 2014	358115581 (H27942041)
DODGE CHARGER	2011 - 2020	358115591 (H27942051)
DODGE RAM 1500	2012 - 2019	358115601 (H27942061)
DODGE RAM 1500-3500	2010 - 2011	358115611 (H27942081)
FORD EXPLORER	2013 - 2019	358115631 (H27942101)
FORD F150 - F550	2015 - 2020	358115641 (H27942111)
FORD F150	2004 - 2014	358115651 (H27942121)
FORD F250 - 550	1999 - 2016	358115661 (H27942131)
FORD TAURUS	2013 - 2019	358115671 (H27942141)

HELLA LED LIGHT BAR CONTROLLER





- 360 adjustable bracket mounting
- Seven auxiliary functions can be switched
- Independent control of power
- Mounted to any angled surface
- Supports controlling of light bar and traffic advisor
- Audio and visible feedback



Description	
HELLA LED Light Bar Controller	358115681 (H27943001)

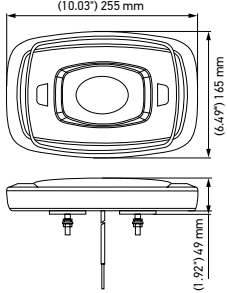

OPTICAL WARNING SYSTEMS

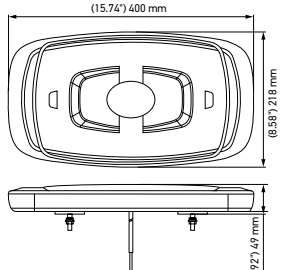
PRODUCT RANGE

Product image / Dimensions	Features	Technical Specifications	Part Number
10" MINI LIGHTBAR 	LED <ul style="list-style-type: none"> • 10" mini lightbar • Amber light output in both clear and amber lenses • Multiple user selectable flashing options including rotating pattern • Bracket or magnetic mounting options • 5 year warranty 	<ul style="list-style-type: none"> • Voltage: 10-30 VDC • Flash Pattern: 10 user selectable flash pattern • Approval: SAE J845 Class 1, ECE-R10, EMC CISPR 25 Class 3, IP6K9K (withstands high pressure cleaning) • Colors: Amber, Amber/White • Power Consumption: 70 Watt • Mounting: Fixed or Magnet mount • Connection: Fixed mount: 20" cable with open wire leads, Magnet: 10ft spiral cable with lighter plug + switches 	014566111 Fixed, Clear Lens, Amber
			014566311* Fixed, Amber Lens, Amber
			014566411 Fixed, Clear Lens, Amber/White
			014566121 Magnet, Clear Lens, Amber
			014566321* Magnet, Amber Lens, Amber
			014566421 Magnet, Clear Lens, Amber/White
NEW			<i>* Special order item</i>

16" MINI LIGHTBAR 	LED <ul style="list-style-type: none"> • 16" mini lightbar • Amber light output in both clear and amber lenses • Multiple user selectable flashing options including rotating pattern • Bracket or magnetic mounting options • 5 year warranty 	<ul style="list-style-type: none"> • Voltage: 10-30 VDC • Flash Pattern: 10 user selectable flash pattern • Approval: SAE J845 Class 1, ECE-R10, EMC CISPR 25 Class 3, IP6K9K (withstands high pressure cleaning) • Colors: Amber, Amber/White • Power Consumption: 70 Watt • Mounting: Fixed or Magnet mount • Connection: Fixed mount: 20" cable with open wire leads, Magnet: 10ft spiral cable with lighter plug + switches 	014565111 Fixed, Clear Lens, Amber
			014565311* Fixed, Amber Lens, Amber
			014565411 Fixed, Clear Lens, Amber/White
			014565121 Magnet, Clear Lens, Amber
			014565321* Magnet, Amber Lens, Amber
			014565421 Magnet, Clear Lens, Amber/White
NEW			<i>* Special order item</i>

MLB 50 LED 	LED <ul style="list-style-type: none"> • 14" classic design mini lightbar • Low power function for night time use • Available in permanent and vacuum magnet mount • 5 year warranty 	<ul style="list-style-type: none"> • Voltage: 10-30 VDC • Flash Pattern: 24 user selectable flash pattern • Approval: SAE J845 Class 1, California Title 13, ECE-R10 • Colors: Amber, Amber/White • Power Consumption: 70 Watt • Mounting: Fixed, Magnet mount • Connection: Fixed mount: 10" cable with open wire leads, Magnet: 10ft spiral cable with lighter plug + switches 	358111431 (H27995001) Fixed Amber
			358111441 (H27995011) Magnet, Amber
			358111451 (H27995021) Fixed Amber/White
			358111461 (H27995031) Magnet Amber/White
			358111471 (H27996001) Fixed Amber
			358111481 (H27996011) Magnet Amber
NEW			<i>* Special order item</i>

MLB 100 LED LIGHT BAR 	LED <ul style="list-style-type: none"> • Non-volatile memory recalls last flash pattern • Multiple units can be synchronized • Reverse polarity protection • Weatherproof and vibration resistant design for external use • 5 year warranty 	<ul style="list-style-type: none"> • Light Source: 30 LEDs • Warning Patterns: 23 Flash Patterns • Operating Voltage: 12 / 24 VDC • Max Power: 50 W • Approvals: SAE J845 Class 1, California Title 13, ECE R65, ECE R10 • Connection Fixed: 12" (30 cm) wire leads • Connection Magnet: 10' (3 m) lighter plug with on/off and pattern select switch • Multi-Unit Sync: Over 15 units • Operating Temperature: -30°C to +60°C • IP Rating: IP67 	358111471 (H27996001) Fixed Amber
			358111481 (H27996011) Magnet Amber
			358111511 (H27996041) Fixed Amber/White
			358111521 (H27996051) Magnet Amber/White
			358111531* (H27996061) Fixed Red/Blue
			358111541* (H27996071) Magnet Red/Blue
358111551* (H27996081) Fixed Blue			
NEW			<i>* Special order item</i>

Product image / Dimensions	Features	Technical Specifications	Part Number
----------------------------	----------	--------------------------	-------------

MLB 200 LED LIGHT BAR

LED

- 16" low profile warning lightbar (just 1.4" height)
- Available in various colors and different mounting options
- Weatherproof and vibration resistant
- 5 year warranty

- Voltage: 10-30 VDC
- Flash Pattern: 24 user selectable flash pattern
- Approval: SAE J845 Class 1, California Title 13, ECE-R10
- Colors: Amber, Amber/White
- Power Consumption: 74 Watt
- Mounting: Fixed, Magnet mount
- Connection: Fixed mount: 10' cable with open wire leads, Magnet: 10ft spiral cable with lighter plug + switches

358111561 (H27997001)	Fixed Mount Amber
358111571 (H27997011)	Magnet Mount Amber
358111581 (H27997021)	Fixed Mount Amber/White
358111591 (H27997031)	Magnet Mount Amber/White



MLB 200 LED COLOR DUAL LIGHT BAR

LED

- 16" low profile warning lightbar (just 1.4" height)
- Dual memory allows for easy switching between two different color modes
- Available in various colors and different mounting options
- 5 year warranty

- Voltage: 10-30 VDC
- Flash Pattern: 24 user selectable flash pattern
- Approval: SAE J845 Class 1, California Title 13, ECE-R10
- Colors: Amber/White, Amber/Blue
- Power Consumption: 72 Watt
- Mounting: Fixed, Magnet mount
- Connection: Fixed mount: 10' cable with open wire leads, Magnet: 10ft spiral cable with lighter plug + switches

358111601 (H27997501)	Fixed Mount Amber/White
358111611 (H27997511)	Magnet Mount Amber/White
358111621 (H27997521)	Fixed Mount Amber/Blue
358111631 (H27997531)	Magnet Mount Amber/Blue

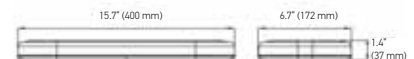

K-LED 100 LED

LED

- Modern round beacon (SAE J845 Class 1)
- High and compact low dome option
- Various mounting options including the DIN pole mount
- 5 year warranty

- Voltage: 10-30 VDC
- Flash Pattern: 11 / 14 user selectable flash pattern
- Approval: SAE J845 Class 1, California Title 13, ECE R65, ECE R10
- Color: Amber
- Power Consumption: 42 / 30 Watt
- Mounting: Fixed, Magnet, Pole mount
- Connection: Fixed mount: 10' cable with open wire leads, Magnet: 10ft spiral cable with lighter plug + switches

358113811 (H27112001)	Fixed Mount
358114791 (H27112011)	Magnet
358114801 (H27112031)	DIN Pole

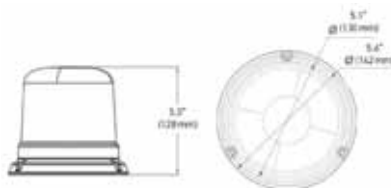

K-LED 100 COMPACT LED

LED

- Modern round beacon (SAE J845 Class 1)
- High and compact low dome option
- Various mounting options including the DIN pole mount
- 5 year warranty





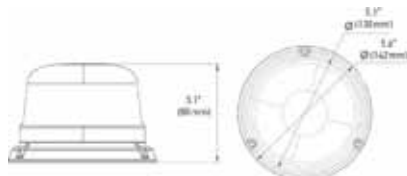

- Voltage: 10-30 VDC
- Flash Pattern: 11 / 14 user selectable flash pattern
- Approval: SAE J845 Class 1, California Title 13, ECE R65, ECE R10
- Color: Amber
- Power Consumption: 42 / 30 Watt
- Mounting: Fixed, Magnet, Pole mount
- Connection: Fixed mount: 10' cable with open wire leads, Magnet: 10ft spiral cable with lighter plug + switches



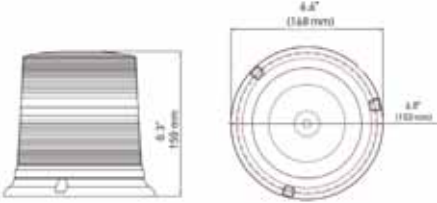

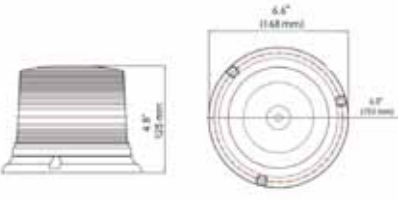
358114821 (H27114001)	Fixed Mount
358114831 (H27114011)	Magnet
358118041	Fixed Mount, 14 FP, bulk 20 pcs
358118051	Fixed Mount, 14 FP, bulk 20 pcs

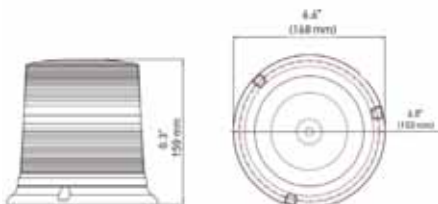

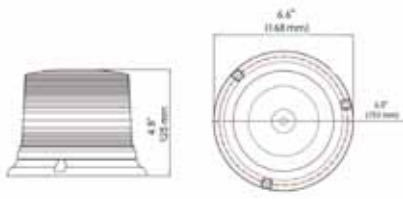
OPTICAL WARNING SYSTEMS

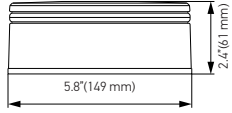
PRODUCT RANGE

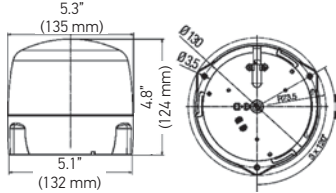

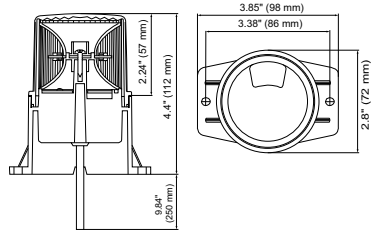

Product image / Dimensions	Features	Technical Specifications	Part Number
<p>K-LED 50</p> 	<p>LED</p> <ul style="list-style-type: none"> • Modern round beacon (SAE J845 Class 1) • High and compact low dome option • Available in amber and white • 5 year warranty 	<ul style="list-style-type: none"> • Voltage: 10-30 VDC • Flash Pattern: 15 user selectable flash pattern • Approval: SAE J845 Class 1, ECE R10 • Colors: Amber, White • Power Consumption: 22 Watt • Mounting: Fixed, Magnet mount • Connection: Fixed mount: 16 " cable with open wire leads, Magnet: 10ft spiral cable with lighter plug + switches 	<p>358114761 (H27111001) Fixed Mount</p> <p>358114771 (H27111011) Magnet</p> <p>358114781 (H27111101) White, Fixed Mount</p>
<p>K-LED 50 COMPACT</p> 	<p>LED</p> <ul style="list-style-type: none"> • Modern round beacon (SAE J845 Class 1) • High and compact low dome option • Available in amber and white • 5 year warranty 	<ul style="list-style-type: none"> • Voltage: 10-30 VDC • Flash Pattern: 15 user selectable flash pattern • Approval: SAE J845 Class 1, ECE R10 • Colors: Amber, White • Power Consumption: 22 Watt • Mounting: Fixed, Magnet mount • Connection: Fixed mount: 16 " cable with open wire leads, Magnet: 10ft spiral cable with lighter plug + switches 	<p>358114811 (H27113001) Fixed Mount</p> <p>358113821 (H27113011) Magnet</p>
<p>K-LED 40</p> 	<p>LED</p> <ul style="list-style-type: none"> • Perfect entry level LED beacon (SAE J845 Class 2) • High and compact low dome option • Available as permanent fixed mount or temporarily magnet mount • 5 year warranty 	<ul style="list-style-type: none"> • Flash Pattern: 5 user selectable flash pattern • Approval: SAE J845 Class 2 • Color: Amber • Power Consumption: 3 Watt • Mounting: Fixed, Magnet mount • Connection: Fixed mount: 16 " cable with open wire leads, Magnet: 10ft spiral cable with lighter plug + switches 	<p>358114701 (H27117001) Fixed Mount</p> <p>358114711 (H27117011) Magnet</p>
<p>K-LED 40 COMPACT</p> 	<p>LED</p> <ul style="list-style-type: none"> • Perfect entry level LED beacon (SAE J845 Class 2) • High and compact low dome option • Available as permanent fixed mount or temporarily magnet mount • 5 year warranty 	<ul style="list-style-type: none"> • Flash Pattern: 5 user selectable flash pattern • Approval: SAE J845 Class 2 • Color: Amber • Power Consumption: 3 Watt • Mounting: Fixed, Magnet mount • Connection: Fixed mount: 16 " cable with open wire leads, Magnet: 10ft spiral cable with lighter plug + switches 	<p>358114681 (H27115001) Fixed Mount</p> <p>358114691 (H27115011) Magnet</p>

Product image / Dimensions	Features	Technical Specifications	Part Number
<p>K-LED REBELUTION</p>  <p>NEW</p>	<p>LED</p> <ul style="list-style-type: none"> • Innovation and change – that’s what the KLED Rebelution beacon stands for. The narrow light exit area is setting new standards in the beacon market. The most striking feature of the KLED Rebelution is its unique and unconventional design. It manages without a classical dome and impresses with its discreet, futuristic styling. • The low profile design gives it a stealth look for a perfect vehicle design integration. • 2 year warranty 	<ul style="list-style-type: none"> • Voltage: 10-30 VDC • Flash Pattern: flashing (1 pattern) or rotating (1 pattern/speed) • Approval: ECE-R65, SAE Class 2 (outstanding) • Color: Amber • Power Consumption: 38 / 13 Watt • Mounting: Fixed mount • Connection: 6 " cable with open wire leads, 	<p>455255001 Fixed, flashing</p> <p>455256001 Fixed, rotating</p>
<p>ROTALED</p> 	<p>LED</p> <ul style="list-style-type: none"> • The classic HELLA LED beacon (SAE J845 Class 1, CT13, ECE,...) • Fulfills all legal requirements • Low energy consumption makes this beacon ideal for continued use • 2 year warranty 	<ul style="list-style-type: none"> • Voltage: 10-30 VDC • Flash Pattern: 5 user selectable flash pattern • Approval: SAE J845 Class 1, ECE R65, ECE R10, CISPR25 Class 5 • Color: Amber • Power Consumption: 10 Watt • Mounting: Fixed, Flex mount • Connection: Fixed mount: cable with open wire leads, Flex: DIN plug 	<p>010979001 Fixed Mount</p> <p>010979011 Flex Mount</p>
<p>FL MINI</p> 	<p>LED</p> <ul style="list-style-type: none"> • Super compact LED beacon (SAE J845 Class 3) • Wide voltage range up to 80 VDC • Designed for Forklifts with UL approval • 2 year warranty 	<ul style="list-style-type: none"> • Voltage: 10-80 VDC • Flash Pattern: 1 flashing pattern • Approval: ECE, SAE J845 Class 3, UL • Color: Amber • Power Consumption: 8 Watt • Mounting: Fixed mount • Connection: Fixed mount: 10 " cable with open wire leads 	<p>014959111 Fixed Mount</p>

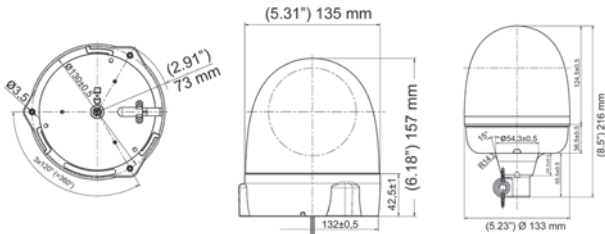
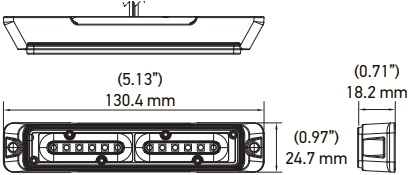
OPTICAL WARNING SYSTEMS

PRODUCT RANGE

Product image / Dimensions	Features	Technical Specifications	Part Number
<p>KL ROTAFLEX / KL ROTAFIX</p> 	<p>HALOGEN</p> <ul style="list-style-type: none"> Sturdy dome with smooth easy-to-clean surface Various mounting options Fixed installation possible from the top or bottom DIN Pole flexible pipe socket with shock absorption 2 year warranty 	<ul style="list-style-type: none"> Voltage: 12 or 24 VDC Flash Pattern: Rotating 160 RPM Approval: SAE J845 Class 1, ECE R65, ECE R10 Color: Amber Power Consumption: 75 / 95 Watt Mounting: Fixed, Magnet, Flex mount Connection: Fixed mount: 7.5" cable with open wires, Magnet: 10' spiral cable with cigarette lighter plug, Flex: DIN plug 	<p>007337001 12 V Fixed Mount</p> <p>007337021* 12 V Magnet</p> <p>006846001 12 V Flex Mount</p> <p>007337011 24 V Fixed Mount</p> <p>007337031* 24 V Magnet</p> <p>006846011 24 V Flex Mount</p> <p>* Special order item</p>
<p>KL ROTA COMPACT</p> 	<p>HALOGEN</p> <ul style="list-style-type: none"> The classic HELLA beacon Fulfills highest legal requirements (SAE J845 Class 1, ECE,...) Modular mounting options to suit all applications 2 year warranty 	<ul style="list-style-type: none"> Voltage: 12 or 24 VDC Flash Pattern: Rotating 180 RPM Approval: SAE J845 Class 1, ECE R65, ECE R10 Color: Amber Power Consumption: 70 / 85 Watt Mounting: Fixed, Flex mount Connection: Fixed mount: 7.5" cable with open wires, Magnet: 10' spiral cable with cigarette lighter plug, Flex: DIN plug 	<p>009506001 12 V Fixed Mount</p> <p>009506011 24 V Flex Mount</p> <p>009506201 12 V Fixed Mount</p>
<p>MS6-DC DUAL COLOR LIGHTHEADS</p> <p>NEW</p> 	<p>LED</p> <ul style="list-style-type: none"> Get twice as much for your money - optical warning strobe + worklight all in one Dual Color LED lighthouse with integrated white scene light override function Lighthouse has a comfortable 7 foot installation cable Multiple units can be grouped to flash simultaneously or alternately 5 year warranty 	<ul style="list-style-type: none"> Voltage: 10-30 VDC Light Source: 2x6 LEDs Flash Pattern: 29 user selectable flash pattern Approval: SAE J595 Class 1 Colors: Red, Blue, Amber with White override function Power Consumption: 18 Watt Housing material: Aluminum Mounting: Screw Connection: 7ft cable with open wire 	<p>358118131 Red + Blue split / all White overwrite</p> <p>358118141 Amber + White split / all White overwrite</p> <p>358118151* All Red / all Blue overwrite</p> <p>358118161* All Red / all White overwrite</p> <p>358118171* All Blue / all White overwrite</p> <p>* Special order item</p>
<p>MS4 TRIPLE COLOR LIGHTHEADS</p> 	<p>LED</p> <ul style="list-style-type: none"> Triple color LED warning strobe with integrated white scene light override function Multiple units can be grouped to flash simultaneously or alternately 5 year warranty 	<ul style="list-style-type: none"> Voltage: 10-30 VDC Light Source: 4x3 LEDs Flash Pattern: 21 user selectable flash pattern (incl. steady on) Approval: SAE J595 Class 1 Colors: Red, Blue, Amber, White with White override function Power Consumption: 18 Watt Housing material: Aluminum Mounting: Screw Connection: 7' cable with open wires 	<p>358111911 (H22899001) Red/ White/ Blue</p> <p>358111921 (H22899011) Amber/ White/ Blue</p>

Product image / Dimensions	Features	Technical Specifications	Part Number
<p>MST6E SLIM STROBE LIGHTHEADS</p> 	<p>LED</p> <ul style="list-style-type: none"> • Super low profile for discreet placement • Frosted lens for glowing body technology and 180 degree visibility • 5 year warranty 	<ul style="list-style-type: none"> • Voltage: 10-30 VDC • Light Source: 6 LEDs • Flash Pattern: 21 user selectable flash pattern • Approval: SAE J595 Class 1 • Colors: Amber, Blue, Red, White and Green • Power Consumption: 6 Watt • Housing material: Plastic • Mounting: Screw + 3M tape • Connection: 8" cable with open wires 	<p>358111691 (H22897001) Amber</p> <p>358111701 (H22897011) Blue</p> <p>358111711 (H22897021) White</p> <p>358111721 (H22897031) Red</p> <p>358111731 (H22897041) Green</p> <p>358111741 (H22897051) Amber/White</p> <p>358111751* (H22897061) Amber/Green</p> <p>358111771* (H22897081) Green/White</p> <p>* Special order item</p>
<p>CONCEALED LED GEN.II LIGHTHEADS</p> 	<p>LED</p> <ul style="list-style-type: none"> • Reliable LED concealed lighthouse set (2 lights, control unit, long install cables) • Pop-in design for easy installation (can be used as hideaways or for surface mounting) • Synchronized units can flash simultaneously or alternately • 5 year warranty 	<ul style="list-style-type: none"> • Voltage: 10-30 VDC • Light Source: 2x6 LEDs • Flash Pattern: 37user selectable flash pattern • Approval: SAE J595 Class 1 • Colors: Amber, White, A/W and Blue/White • Power Consumption: 12 Watt • Housing material: Aluminum • Mounting: Screw • Connection: 3ft + 10ft cable with easy connectors 	<p>358111941* (H22901001) Amber</p> <p>358111951* (H22901021) White</p> <p>358111961 (H22901031) Amber/White</p> <p>358111971* (H22901041) Blue/White</p> <p>* Special order item</p>
<p>MS6 STROBE LIGHTHEADS</p> 	<p>LED</p> <ul style="list-style-type: none"> • Classic 6 LED warning strobe • Black aluminum base for maximum heat dissipation • Fulfills all legal requirements (SAE J845 Class 1, CT13, ...) • Synchronized units can flash simultaneously or alternately • 5 year warranty 	<ul style="list-style-type: none"> • Voltage: 10-30 VDC • Light Source: 6 LEDs • Flash Pattern: 19 user selectable flash pattern • Approval: SAE J595 Class 1, California Title 13 • Colors: Amber, Blue, Red and White • Power Consumption: 10 Watt • Housing material: Aluminum • Mounting: Screw • Connection: 4" cable with open wires 	<p>358111151 (H22890001) Amber</p> <p>358111161 (H22890021) White</p> <p>358111171 (H22890031) Blue</p> <p>358111181 (H22890041) Red</p> <p>358111191 (H22890051) Amber/White</p> <p>358111201 (H22890061) Red/Blue</p> <p>358111211 (H22890071) Red/White</p>
<p>MST6 SLIM STROBE LIGHTHEADS</p> 	<p>LED</p> <ul style="list-style-type: none"> • Super low profile for discreet placement • Fulfills all legal requirements (SAE J845 Class 1, CT13, ...) • Synchronized units can flash simultaneously or alternately • 5 year warranty 	<ul style="list-style-type: none"> • Voltage: 10-30 VDC • Light Source: 6 LEDs • Flash Pattern: 23 user selectable flash pattern • Approval: SAE J595 Class 1, California Title 13 • Colors: Amber, Blue, Red and White • Power Consumption: 6 Watt • Housing material: Plastic • Mounting: Screw • Connection: 8" cable with open wires 	<p>358111321 (H22895001) Amber</p> <p>358111331* (H22895021) Blue</p> <p>358111341 (H22895031) White</p> <p>358111351* (H22895041) Red</p> <p>358111361 (H22895051) Amber/White</p> <p>358111371 (H22895061) Red/Blue</p> <p>* Special order item</p>

OPTICAL WARNING SYSTEMS

PRODUCT RANGE

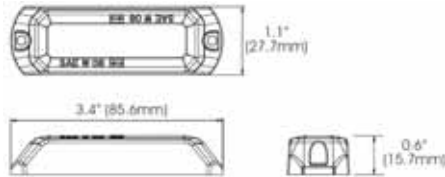
Product image / Dimensions	Features	Technical Specifications	Part Number
MS3 MINI LED LIGHTHEADS 	LED <ul style="list-style-type: none"> • Compact 3 LED warning strobe • Black aluminum base for maximum heat dissipation • Fulfills all legal requirements (SAE J845 Class 1, CT13, ...) • Synchronized units can flash simultaneously or alternately • 5 year warranty 	<ul style="list-style-type: none"> • Voltage: 10-30 VDC • Light Source: 3 LEDs • Flash Pattern: 12 user selectable flash pattern • Approval: SAE J595 Class 1, California Title 13 • Colors: Amber, White • Power Consumption: 5 Watt • Housing material: Aluminum • Mounting: Screw • Connection: 4" cable with open wires 	358111221 (H22891001) Amber
			358111241 (H22891031) White
			

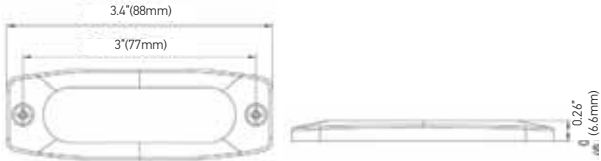
MST3 SLIM STROBE LIGHTHEADS 	LED <ul style="list-style-type: none"> • Super compact and low profile flasher for discreet placement • Fulfills all legal requirements (SAE J845 Class 1, CT13, ...) • Synchronized units can flash simultaneously or alternately • 5 year warranty 	<ul style="list-style-type: none"> • Voltage: 10-30 VDC • Light Source: 3 LEDs • Flash Pattern: 12 user selectable flash pattern • Approval: SAE J595 Class 1, California Title 13 • Colors: Amber, Blue, Red and White • Power Consumption: 3 Watt • Housing material: Plastic • Mounting: Screw • Connection: 8 " cable with open wires 	358111001 (H22896001) Amber
			358111011 (H22896021) Blue
			358117131 (H22896041) White
			358117121 (H22896031) Red
			

LOW PROFILE LED WARNING AND TRAFFIC STICKS 	LED <ul style="list-style-type: none"> • Super low profile for stealth look and minimize rear view obstruction • Non-volatile memory recalls last flash pattern used at power up • Reverse battery protection • Available in amber, white, red, blue, and green • Available as components to build your own custom color configurations • 5 year warranty 	<ul style="list-style-type: none"> • Light Source: 3 LEDs per lighthouse • Warning Patterns: 27 Patterns (Warning version) / 31 Patterns (Traffic version) • Operating Voltage: 12 - 24 VDC • Max Power: 4 Heads = 24.4 W • Max Power: 6 Heads = 37.2 W • Max Power: 8 Heads = 48.7 W • Approvals: SAE J595 Class 1(1), California Title 13(2), ECE R10 • Colors: Amber, White, Red, Blue, Green • Connection Warning Stick: 3' (40 cm) cable / wire leads • Connection Traffic Stick: 15' (4.5 m) cable / wire leads • Operating Temperature: -30°C to +60°C • IP Rating: IPX5 	358111401* (H27914001) 4 Lighthoods Amber
			358111411* (H27915001) 6 Lighthoods Amber
			358111421* (H27916001) 8 Lighthoods Amber
			358115731 (H27918101) Single LED Pod - Amber
			358115741* (H27918111) Single LED Pod - White
			358115751* (H27918121) Single LED Pod - Red
			358115761* (H27918131) Single LED Pod - Blue
			358116751 (H27919041) 6 Switch Control Panel
			358114391 (H27919051) 4 Switch Control Panel
			<p>* Special order item</p>



6 Button Control Panel with LED Display



4 Switch Control Panel

Find the right product with ease



The purpose of our online information is to provide you with more ways to efficiently and conveniently identify the latest HELLA products and obtain important information about them. No matter what you are looking for, we are sure to have the right product in our range!

- Product information
- Product videos
- 3D animations
- Configuration tools for many Applications
- Interactive applications for phones smart and tablets
- LIGHTING technology comparisons
- Adjustment recommendations

ELIVER - WORK LIGHTS and OPTICAL WARNING SYSTEMS simulator

This online tool allows you to compare the light distribution of WORK LIGHTS and flash patterns of HELLA products in a realistic environment.



www.hella.com/eliver

WORK LIGHT CONFIGURATOR

Which work lamp is the right choice for your application? The HELLA online configurator provides you with matching product recommendations, including all relevant product information.



www.hella.com/worklight-configurator

HELLA MINING

The HELLA Mining Center of Excellence was created in Australia in 2002 to design, develop and manufacture lighting products specifically for the mining industry. HELLA uses its research, engineering and logistics expertise to produce lighting products designed to meet world class standards that can be used in mining applications worldwide.

HELLA Mining products meet the needs of mining companies. The concept of "Technology with Vision" highlights the fact that we exceed the expectations of our customers by producing quality products that meet the requirements for the toughest industry on the planet in an efficient, advanced and professional manner, offering real technology with vision to future.



www.hellamining.com

MICROSITE: Find more information about HELLA Mining

MICROSITE: Find more information about HELLA MARINE:



www.hellamarine.com



HELLA MARINE

HELLA MARINE is headquartered in Auckland, New Zealand, a country with a rich maritime history, world class boat building and yacht racing success.

Combining this passion for the ocean with decades of experience in the design of LED products, HELLA MARINE lights are totally compatible and feature functional design, offering total peace of mind, safety and durability at sea. Through research and development, innovative design and the use of high quality materials, HELLA MARINE continues to establish benchmarks for extremely reliable and highly efficient products.

At present, HELLA MARINE is a world-renowned and reliable brand in navigation for its high-performance LED LIGHTING systems, available in more than 60 countries through the HELLA global network and specialized maritime distributors.



HELLA BULBS

Simulations and calculations have been used to support the development of headlights for many years. However, this information alone can not replace the actual impression of lighting as seen in the largest European Light test center in HELLA facilities Lippstadt, Germany.



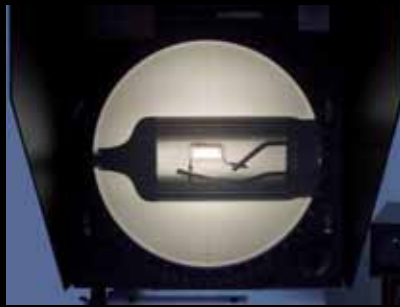

Geometrical Measurement

A measuring projector is used to check the filament geometry - with regard to the statutory standards in accordance with IEC 60810. The filament must be dimensioned and positioned within bulb specifications.



Vibration and Shock Test

Here, vibration resistance of the bulb and the filament in particular, are tested on an electrodynamic vibration table.



Life Test

Sophisticated tests are used to prove the high reliability of the HELLA bulbs over a long period.



Paint Adhesion Test

The adhesion of paint on colored glass bulbs -such as the PY21W for example - are tested in a climate chamber at different temperatures and air humidities. Optimum adhesion of glass bulb paint guarantees the prescribed amber indicator light over the whole service life period.



Light Flux Measurement

The Ulbricht sphere and goniometer are used to determine the light fluxes and luminous intensities of the HELLA bulbs.



All the aforementioned tests and the forms of light measurement require technical capacity that can only be found in HELLA production plants.

Compliance with World Class Standards



DOT



SAE
INTERNATIONAL

Q
OCP 0009 **INMETRO**

ARAI
Progress through Research

SCC

HELLA HALOGEN BULBS

PRODUCT RANGE



Standard



+50



Long Life

STANDARD

HELLA standard halogen bulbs provide a quality of original equipment manufacturer and great value for your money. The optimal balance between performance and service life. With SAE / ECE and INMETRO approval (when applicable).

- Halogen and Miniature **See page 88**
- Emergency Set **See page 109**
- LED Miniature bulbs **See page 110**
- Bulbs for Motorcycles **See page 126**
- Halogen 12 V Blister Pack **See page 116**
- Miniature Blister Pack **See page 117**
- Halogen 24 V Blister Pack **See page 118**

PERFORMANCE

Our bulbs are establishing new reference points for halogen lighting, making driving safer and more pleasant, providing a beam of light with greater intensity compared to HELLA Standard bulbs. The opaque silver lid offers an elegant look in the clear glass headlights

- High Performance 2.0 **See page 120**
- +50 **See page 121**

LONG LIFE

HELLA Long Life halogen bulbs have a long service life up to 2 times longer than HELLA standard bulbs and are more environmentally friendly, as they do not have to be replaced frequently. Provides an optimal value for your money and the best selection for frequent travelers.

See page 119



Clear Blue

Xtreme Yellow

High Performance 2.0

OPTILUX Extreme White XB

HEAVY DUTY / DOUBLE POWER

Double power of 24V produces the light by means of a single filament. Heavy duty bulbs offer more power, more safety, without dazzling traffic.

The double power reduces costs by increasing the life of up to 100%.

- Heavy Duty See page 123
- Double Power See page 123

HIGH WATTAGE

It offers more light, with double brightness compared to HELLA standard halogen bulbs and greater luminous efficiency, its Special filament guarantees safety and relaxed driving in off-road conditions.

Note: Take into account that due to the high wattage it can generate on heating the wiring of the headlight.





















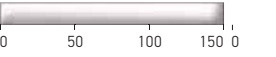

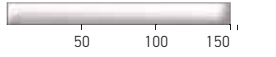

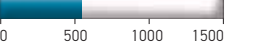
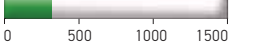
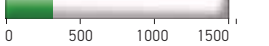

See page 122

DESIGN

Our design bulbs meet special requirements regarding design and safety. The xenon-like effect makes whiter light the correct alternative for design-oriented drivers. Our range of products:

OPTILUX

- Extreme Yellow XY See page 124
- Extreme White XB See page 125

STANDARD	PERFORMANCE		LONG LIFE	HEAVY DUTY
Standard	High Performance 2.0	+50	Long Life	Heavy Duty Double Power
				
				
<p>Features: 12 V / 24 V Best mixture of light output and reliability. Original equipment quality with excellent luminous efficiency and the best quality / price ratio. Meets global standard (ECE R37 & SAE/DOT and INMETRO regulation).</p>	<p>Features: 12 V Up to 100% more light than HELLA standard bulbs Meets global standard (ECE R37 & SAE/DOT and INMETRO regulation). Specially designed by halogen mixing gas & filament.</p>	<p>Features: 12 V Up to 50% more light output than HELLA standard bulbs Meets global standard (ECE R37 & SAE/DOT and INMETRO regulation). Filament design optimized. Wider and brighter light OE quality. With silver top coating to be invisible in the headlight</p>	<p>Features: 12 V / 24 V Up to 200% longer life time than HELLA standard bulbs. Special mixture of halogen gases to achieve high durability and increase lifetime. Meets global standard (ECE R37 & SAE/DOT regulation).</p>	<p>Features: 24 V Increased vibration resistance All advantages of standard bulbs Reduced downtime cost due to less bulb changes</p>
Extra light output [%] *	Extra light output [%] *	Extra light output [%] *	Extra light output [%] *	Extra light output [%] *
				
Light colour [K]	Light colour [K]	Light colour [K]	Light colour [K]	Light colour [K]
				
Service life [h] **	Service life [h] **	Service life [h] **	Service life [h] **	Service life [h] **
				
<p>Packaging: Individual box, blister pack</p>	<p>Packaging: Blister pack</p>	<p>Packaging: Individual box, blister pack</p>	<p>Packaging: Individual box</p>	<p>Packaging: Individual box, blister pack</p>
<p>Applications:</p> 	<p>Applications:</p> 	<p>Applications:</p> 	<p>Applications:</p> 	<p>Applications:</p> 
<p>Available in: 862, 880, 881, 884, 885, 886, 887, 888, 889, 890, 891, 892, 893, 894, 896, 898, 899, 9003, 9004, 9005, 9005XS, 9006, 9006XS, 9007, H1, H2, H3, H4, H7, H8, H9, H10 (9145), H11, H12 (9055), H13, H16, HS1, H20W, H21W, H5W, H6W</p>	<p>Available in: H1, H3, H7, H9, H11, H13 (9008), 9003, 9004 (HB1), 9005 (HB3), 9006 (HB4), 9007 (HB5)</p>	<p>Available in: H1P50, H3P50, H4P50, H7P50, H11P50, H13P50, 9004P50, 9005P50, 9006P50, 9007P50</p>	<p>Available in: H1LL, H1 24V LL, H3 24LL, H4LL, H4 24V LL, H7 24LL, H7LL, H11LL, H13LL, 9003LL, 9004LL, 9005LL, 9006LL, 9007LL</p>	<p>Available in: 198HD, 5637HD, 7510LTS, H3 24V HD, H3HD, H4 24V HD</p> <p>Double Power: H1 24V DP, H3 24V DP, H4 24V DP, H4 24V DP, H7 24V DP, H11 24V DP</p>



HIGH WATTAGE **OPTILUX**

High Wattage **Optilux Extreme Yellow XY** **Optilux Extreme White XB**



Features:
12 V
Longer service life compared to standard HELLA bulbs
Environmentally friendly, because they do not have to be replaced as often. Excellent luminous efficiency.
Excellent quality / price
For off-road use only

Features:
12 V
The XY Optilux bulbs produce a clear yellow light their filament is made of specific measures to provide the exact amount of light needed in the way.

Features:
12 V
Extreme White bulbs XB Optilux give a radical look at the xenon light in a halogen bulb, with its blue coating. These bulbs incorporate gas xenon bulb improved performance

* Compared to standard HELLA bulbs
** Service life in hours based on the performance of the H7 bulb

Extra light output [%] *

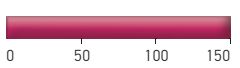

Extra light output [%] *

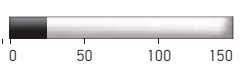

Extra light output [%] *

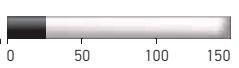

Light colour [K]

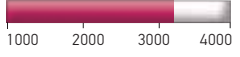

Light colour [K]

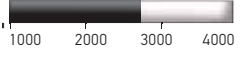

Light colour [K]

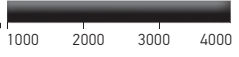

Service life [h] **



Service life [h] **

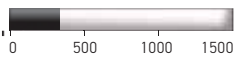

Service life [h] **



Packaging:
Individual box, blister pack

Packaging:
Plastic Case

Packaging:
Plastic Case

Applications:

Applications:

Applications:

Available in:
H1 100W, H1 130W, H2 100W
H3 100W, H3 130W,
H3 24V 100W, H4 100/55W
H4 100/80W, H4 130/90W
H4 24V 100/90W, H7 100W
H7 70W, 9004 100/80W
9005 100W, 9006 80W
9007 100/80W

Available in:
880, 881, 893, 9006,
H1, H10, H11, H13,
H16E, H3, H3C, H4
H7, H8, H9, HB1,
HB3, HB4, HB5

Available in:
880, 881, 893, 9004,
9005, 9006, 9007, H1,
H10, H11, H13, H16,
H2, H3, H3C, H4, H7,
H8, H9, HB1, HB3, HB4,
HB5



PRODUCT RANGE

COMPLIES WITH ECE, SAE AND INMETRO STANDARD*

*Where applicable



STANDARD
Standard Halogen Bulbs - 12 V

862	898	H3 35W	H15
880	899	H4	H16
881	9003	H4 35/35W	HS1
884	9004	H4 45/45W	H10W
885	9005	H4 P45T	H20W
886	9005XS	H7	H21W
887	9006	H8	H5W
888	9006XS	◆ H8B	H6W
889	9007	H9	◆ M5 35/35W
890	9009S	◆ H9B	◆ M5 35/35W1
891	HIR2	H10 (9145)	◆ M5 25/25W
892	H1	H11	◆ M5 25/25W1
893	H2	H11B	◆ M5 18/18W
894	H3	H12 (9055)	◆ M5 35/35W3
896	H3C	H13	◆ M5 25/25W3

Standard Halogen Bulbs - 24 V

H1 24V	H7 24V
H3 24V	H11 24V
H4 24V	H21W 24V

STANDARD
Standard Halogen Bulbs Blister Pack - 12 V



Double Blister Pack	Single Blister Pack
9003TB, 9004TB,	9003SB, 9004SB,
9005TB, 9006TB,	9005SB, 9006SB,
9007TB, H1TB,	9007SB, H1SB,
H10TB, H11TB,	H10SB, H11SB,
H13TB, H3TB,	H13SB, H3SB,
H3 35WTB, H4TB,	H3 35WSB, H4SB,
H4 35/35WTB,	H4 35/35WSB,
H4 45/45WTB,	H4 45/45WSB,
H4 P45TTB,	H4 P45TSB, H7SB,
H7TB, H8TB,	H8SB, H9SB,
H9TB, HS1TB	HS1SB, H16SB
◆ M5 35/35WTB	◆ M5 35/35WSB

◆ **Standard Halogen Bulbs Blister Pack - 24 V**

Double Blister Pack	Single Blister Pack
H1 24VTB	H1 24VSB
H3 24VTB	H3 24VSB
H4 24VTB	H4 24VSB
H7 24VTB	H7 24VSB
H9 24VTB	H9 24VSB
H11 24VTB	H11 24VSB



STANDARD
Miniature Bulbs - (Box - Multiple voltages)

17	194R	3157NA	6411	7507
1003	198HD	3457	6413	7507C
1004	199	3457NA	6418	7511
1034	2057	3496	6423	7528
1034A	2057NA	3497	6424	7533
1034NA	2357	3652	6428	7534
1073	2357NA	37	6429	7537
1141	2396	3757A	6430	7951
1141 24V	2397	3796	6438	7951 55/50W
1156	24	3797	6451	7952
1156NA	24NA	3799	6453	89
1157	265	3893	6475	90
1157A	2721	3898	6476	912
1157NA	2741	3899	6480	921
1176	2722	3930	660	921NA
1176A	2723	400	67	93
1224	2741	5007	7225	9507
1308	2820	5008	7240	97
1445	2821	51	73	A3603
158	2825	53	74	A3625
158A	2825BL	57	7440	DE3021
168	2840	5627	7440A	DE3022
1683	2841	5637	7440NA	DE3175
1816	2845	5637HD	7441	DE3425
1891	2827NA	6235	7443	JC5
1893	3047	6245	7443A	JC10
1895	3047LL	6260	7443NA	JC20
194	3057	63	7506	PSX24W
194NA	3156	631	7506A	
194B	3157	635	7506NA	

STANDARD
Miniature Bulbs Blister Pack

Double Blister Pack	Single Blister Pack
7506TB	168TB
1034TB	73TB
2825TB	53TB
7528TB	1157TB
921TB	7507CTB
7443TB	1141TB
158TB	7506ATB
5007TB	6418TB
67TB	DE3021TB
3898TB	7225TB
3157TB	2827NATB
5008TB	2821TB
5637TB	7507CTB
3893TB	1141TB
7440TB	7506ATB
7507TB	6418TB
DE3175TB	DE3021TB
6411TB	7225TB
2721TB	2827NATB
	2821TB

◆ **Miniature Bulbs, Blister Pack - 24 V**

Double Blister Pack	Single Blister Pack
1141 24VTB	6429TB
2741TB	7510LTSTB
2841TB	7511TB
2845TB	7534TB
3797TB	7537TB
3930TB	7952TB
5627TB	9507TB
6423TB	
	1141 24VSB
	2845SB
	5627SB
	7511SB
	7537SB

STANDARD
Xenon Lamps (HID)

D1S 4300 K
D2S 4300 K
D2R 4300 K
D3S 4300 K
D4S 4300 K



PERFORMANCE
Xenon Lamps +30 (HID)

D1S 5000 K
D2S 5000 K
D2R 5000 K



LED
LED Bulbs



5000 K	6500 K
6411LED 5K	6411LED 6.5K
6418LED 5K	6418LED 6.5K
921LED 5K	921LED 6.5K

LONG LIFE
Long Life 12 V and 24 V

9003LL	H1LL
9004LL	H4 24V LL
9005LL	H7 24V LL
9006LL	H7LL
9007LL	H11LL

Long Life Miniature Bulbs

1003LL	3157LL
1141LL	7440LL
1156LL	7443LL
1157LL	
2057LL	
2057NALL	
2357LL	
3047LL	





A: Amber glass



NA: Natural Amber glass

The "Amber Crystal" bulbs have an amber tint on their crystal.
The "Natural amber glass" bulbs are made with a mixture of minerals that provide the amber color in the crystal.

Part No. Nomenclature

- A: Amber glass
- NA: Natural amber glass
- BL: Blue crystal
- R: Red crystal
- C: Clear glass, (transparent)
- CB: Light blue glass
- TCB: Light blue glass - two pieces
- P50: 50% more light than standard HELLA bulbs
- HD: Heavy equipment
- YL: Yellow glass
- TB: Blister Pack double
- ◆: New product



PERFORMANCE

+50 - 12V

Box	Double Blister Pack
H1P50	H1P50TB
H4P50	H3P50TB
H3P50	H4P50TB
H7P50	H7P50TB
H11P50	H11P50TB
H13P50	H13P50TB
9004P50	9004P50TB
9005P50	9005P50TB
9006P50	9006P50TB
9007P50	9007P50TB

HIGH WATTAGE

High Wattage 12 V

Single box	Double Blister Pack	Single Blister Pack
H1 100W	H1 100WTB	H4 100/80WSB
H1 130W	H3 100WTB	9007 100/80WSB
H2 100W	H3 130WTB	9004 100/80WSB
H3 100W	H4 100/55WTB	9006 80WSB
H3 130W	H4 100/80WTB	9005 100WSB
H3 24V 100W	H4 130/90WTB	
H4 100/55W	H7 100WTB	
H4 100/80W	9004 100/80WTB	
H4 130/90W	9005 100WTB	
H4 24V 100/90W	9006 80WTB	
H7 100W	9007 100/80WTB	
H7 70W		
9004 100/80W	◆ H3 24V 100WTB	
9005 100W	◆ H4 24V 100/90WTB	
9006 80W		
9007 100/80W		

Notice that due to the high consumption it can be generated on heating in the wiring of the headlight.

DOUBLE POWER

HEAVY DUTY

Heavy Duty - 12 V and 24 V

Halogen	Miniature
H3HD	198HD
H3 24V HD	5637HD
H4 24V HD	7510LTS
H1 24V DP	◆ Single Blister Pack ◆ Double Blister Pack
H3 24V DP	H1 24V DPSB
H4 24V DP	H3 24V HDSB
H7 24V DP	H3 24V DPSB
H11 24V DP	H4 24V HDSB
	H4 24V DPSB
	H7 24V DPSB
	H11 24V DPSB

PERFORMANCE

High Performance 2.0

Double Blister Pack	
H1 2.0TB	9004 2.0TB
H3 2.0TB	9003 2.0TB
H7 2.0TB	9005 2.0TB
H9 2.0TB	9006 2.0TB
H11 2.0TB	9007 2.0TB
H13 2.0TB	

STANDARD

Emergency Set

Halogen bulb, miniature bulbs and fuses

H7EMK
H4EMK
H1EMK
9005EMK
9006EMK
H724VEMK
H424VEMK



Double Plastic Case

DESIGN

Optilux Extreme White XB - 12V

880	32 W	H71071212
881	32 W	H71071222
893	37.5 W	H71071232
9004	65/45 W	H71071392
9005	65 W	H71071402
9005	65 W	H71071412
9005	100 W	H71071422
9006	55 W	H71071432
9006	55 W	H71071442
9006	80 W	H71071452
9007	65/55 W	H71071472
H1	55 W	H71071242
H10	65 W	H71071012
H10	42 W	H71071252
H11	80 W	H71071032
H11	55 W	H71071262
H13	100/80 W	H71071052
H13	60/55 W	H71071272
H16	35 W	H71071282
H2	100 W	H71070227
H3	100 W	H71070181
H3	55 W	H71071312
H3C	55 W	H71071322
H3C	80 W	H71071332
H4	100/80 W	H71070201
H4	60/55 W	H71071352
H7	100 W	H71070307
H7	55 W	H71071362
H8	55 W	H71070772
H8	35 W	H71071372
H9	100 W	H71070792
H9	65 W	H71071382
HB1	100/80 W	H71070327
HB3	100 W	H71070347
HB4	80 W	H71070367
HB5	100/80 W	H71070387

Double Plastic Case

DESIGN

Optilux Extreme Yellow XY - 12V

880	27 W	H71071172
881	27 W	H71071182
893	37.5 W	H71071192
9006	55 W	H71071462
H1	55 W	H71070642
H10	42 W	H71071112
H11	55 W	H71071132
H13	60/55 W	H71071152
H16	35 W	H71071302
H3	55 W	H71070662
H3C	55 W	H71071342
H4	60/55 W	H71070682
H7	55 W	H71070702
H8	35 W	H71071072
H9	65 W	H71071092
HB1	65/45 W	H71070562
HB3	65 W	H71070582
HB4	55 W	H71070602
HB5	60/55 W	H71070622

PRODUCT RANGE

BULBS SUMMARY

1 HEADLIGHT

HALOGEN STANDARD BULBS

LOW BEAM HIGH BEAM * FOG LIGHT (WHERE APPLICABLE)

H1*	H2	H3*	H3C*	H4*	H7*	H8*	H8B*	H9	H9B*	H10	H11	H11B	H12
H13	H15	H16	9003	9004	9005*	9005XS	9006	9006XS	9007	862*	880*		
881*	884*	HS1	7951	HIR2	M5	XENON		D1S	D2S	D2R	D3S	D4S	

2 INDICATORS

FRONT REAR SIDE

7507C	7506NA	3156	3157	H21W	H6W
P21W	PY21W	P27W	P27/7W		
7440	7440NA	158A	6411	6411	2825
W21W	WY21W	WY5W	LED	W5W	5008
					R10W

3 POSITION LIGHT

FRONT REAR

3893	194	2845	7440	7443
T4W	W3W	W5W	W21W	W21/5W
5007	5008	6428	6413	H5W
R5W	R10W		C5W	H6W
				H10W

4 REVERSE LIGHT

7506	7440	DE3175	H21W	H6W
P21W	W21W	C10W		

5 DASHBOARD

2721	007997051
------	-----------

6 LICENSE PLATE LIGHT

7225	7537	5007	194
P21/4W	P21/5W	R5W	W3W
7440	7443	5008	2825
W21W	W21/5W	R10W	W5W

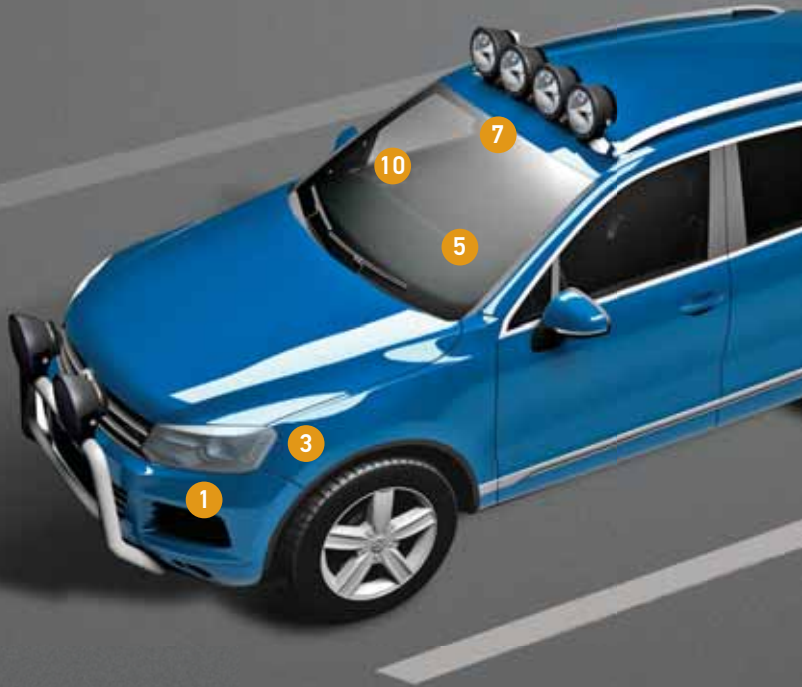

<p>1</p> <p>PERFORMANCE</p> <p>+50%</p> <table border="0"> <tr><td>H1P50TB</td><td>9004P50TB</td></tr> <tr><td>H3P50TB</td><td>9005P50TB</td></tr> <tr><td>H4P50TB</td><td>9006P50TB</td></tr> <tr><td>H7P50TB</td><td>9007P50TB</td></tr> <tr><td>H11P50TB</td><td></td></tr> <tr><td>H13P50TB</td><td></td></tr> </table>	H1P50TB	9004P50TB	H3P50TB	9005P50TB	H4P50TB	9006P50TB	H7P50TB	9007P50TB	H11P50TB		H13P50TB		<p>PERFORMANCE</p> <p>High Performance 2.0</p> <table border="0"> <tr><td>H1 2.0TB</td><td>9004 2.0TB</td></tr> <tr><td>H3 2.0TB</td><td>9003 2.0TB</td></tr> <tr><td>H7 2.0TB</td><td>9005 2.0TB</td></tr> <tr><td>H9 2.0TB</td><td>9006 2.0TB</td></tr> <tr><td>H11 2.0TB</td><td>9007 2.0TB</td></tr> <tr><td>H13 2.0TB</td><td></td></tr> </table>	H1 2.0TB	9004 2.0TB	H3 2.0TB	9003 2.0TB	H7 2.0TB	9005 2.0TB	H9 2.0TB	9006 2.0TB	H11 2.0TB	9007 2.0TB	H13 2.0TB		<p>HEAVY DUTY</p> <p>Heavy Duty</p> <table border="0"> <tr><td>H3HD</td><td>H11 24V DP</td></tr> <tr><td>H3 24V HD</td><td>198HD</td></tr> <tr><td>H4 24V HD</td><td>5637HD</td></tr> <tr><td>H1 24V DP</td><td>7510LTS</td></tr> <tr><td>H3 24V DP</td><td></td></tr> <tr><td>H4 24V DP</td><td></td></tr> <tr><td>H7 24V DP</td><td></td></tr> </table>	H3HD	H11 24V DP	H3 24V HD	198HD	H4 24V HD	5637HD	H1 24V DP	7510LTS	H3 24V DP		H4 24V DP		H7 24V DP		<p>STANDARD</p> <p>Bulbs and fuses set</p> <table border="0"> <tr><td>H7EMK</td><td>9006EMK</td></tr> <tr><td>H4EMK</td><td>H724VEMK</td></tr> <tr><td>H1EMK</td><td>H424VEMK</td></tr> <tr><td>9005EMK</td><td></td></tr> </table>	H7EMK	9006EMK	H4EMK	H724VEMK	H1EMK	H424VEMK	9005EMK																			
H1P50TB	9004P50TB																																																																		
H3P50TB	9005P50TB																																																																		
H4P50TB	9006P50TB																																																																		
H7P50TB	9007P50TB																																																																		
H11P50TB																																																																			
H13P50TB																																																																			
H1 2.0TB	9004 2.0TB																																																																		
H3 2.0TB	9003 2.0TB																																																																		
H7 2.0TB	9005 2.0TB																																																																		
H9 2.0TB	9006 2.0TB																																																																		
H11 2.0TB	9007 2.0TB																																																																		
H13 2.0TB																																																																			
H3HD	H11 24V DP																																																																		
H3 24V HD	198HD																																																																		
H4 24V HD	5637HD																																																																		
H1 24V DP	7510LTS																																																																		
H3 24V DP																																																																			
H4 24V DP																																																																			
H7 24V DP																																																																			
H7EMK	9006EMK																																																																		
H4EMK	H724VEMK																																																																		
H1EMK	H424VEMK																																																																		
9005EMK																																																																			
<p>LONG LIFE</p> <p>Long Life</p> <table border="0"> <tr><td>H1LL</td><td>9003LL</td></tr> <tr><td>H3LL</td><td>9004LL</td></tr> <tr><td>H4LL</td><td>9005LL</td></tr> <tr><td>H7LL</td><td>9006LL</td></tr> <tr><td>H11LL</td><td>9007LL</td></tr> <tr><td>H13LL</td><td></td></tr> </table>	H1LL	9003LL	H3LL	9004LL	H4LL	9005LL	H7LL	9006LL	H11LL	9007LL	H13LL		<p>DESIGN</p> <p>OPTILUX Extreme White XB</p> <table border="0"> <tr><td>880</td><td>H10</td></tr> <tr><td>881</td><td>H11</td></tr> <tr><td>893</td><td>H13/9008</td></tr> <tr><td>H1</td><td>H16/9009</td></tr> <tr><td>H3</td><td>9004 / HB1</td></tr> <tr><td>H3C</td><td>9005 / HB3</td></tr> <tr><td>H4/9003</td><td>9005XS</td></tr> <tr><td>H7</td><td>9006 / HB4</td></tr> <tr><td>H8</td><td>9006XS</td></tr> <tr><td>H9</td><td>9007 / HB5</td></tr> </table>	880	H10	881	H11	893	H13/9008	H1	H16/9009	H3	9004 / HB1	H3C	9005 / HB3	H4/9003	9005XS	H7	9006 / HB4	H8	9006XS	H9	9007 / HB5	<p>DESIGN</p> <p>OPTILUX Extreme Yellow XY</p> <table border="0"> <tr><td>880</td><td>H9</td></tr> <tr><td>881</td><td>H10</td></tr> <tr><td>893</td><td>H11</td></tr> <tr><td>894</td><td>H13/9008</td></tr> <tr><td>H1</td><td>H16/9009</td></tr> <tr><td>H3</td><td>9004 / HB1</td></tr> <tr><td>H3C</td><td>9005 / HB3</td></tr> <tr><td>H4/9003</td><td>9006 / HB4</td></tr> <tr><td>H7</td><td>9006XS</td></tr> <tr><td>H8</td><td>9007 / HB5</td></tr> </table>	880	H9	881	H10	893	H11	894	H13/9008	H1	H16/9009	H3	9004 / HB1	H3C	9005 / HB3	H4/9003	9006 / HB4	H7	9006XS	H8	9007 / HB5	<p>HIGH WATTAGE</p> <p>High Wattage</p> <table border="0"> <tr><td>H1 100WTB</td></tr> <tr><td>H3 100WTB</td></tr> <tr><td>H3 130WTB</td></tr> <tr><td>9004 100/80WTB</td></tr> <tr><td>9005 100WTB</td></tr> <tr><td>9006 80WTB</td></tr> <tr><td>9007 100/80WTB</td></tr> <tr><td>H4 100/55WTB</td></tr> <tr><td>H4 100/80WTB</td></tr> <tr><td>H4 130/90WTB</td></tr> <tr><td>H7 100WTB</td></tr> <tr><td>H11 24V DP</td></tr> </table>	H1 100WTB	H3 100WTB	H3 130WTB	9004 100/80WTB	9005 100WTB	9006 80WTB	9007 100/80WTB	H4 100/55WTB	H4 100/80WTB	H4 130/90WTB	H7 100WTB	H11 24V DP
H1LL	9003LL																																																																		
H3LL	9004LL																																																																		
H4LL	9005LL																																																																		
H7LL	9006LL																																																																		
H11LL	9007LL																																																																		
H13LL																																																																			
880	H10																																																																		
881	H11																																																																		
893	H13/9008																																																																		
H1	H16/9009																																																																		
H3	9004 / HB1																																																																		
H3C	9005 / HB3																																																																		
H4/9003	9005XS																																																																		
H7	9006 / HB4																																																																		
H8	9006XS																																																																		
H9	9007 / HB5																																																																		
880	H9																																																																		
881	H10																																																																		
893	H11																																																																		
894	H13/9008																																																																		
H1	H16/9009																																																																		
H3	9004 / HB1																																																																		
H3C	9005 / HB3																																																																		
H4/9003	9006 / HB4																																																																		
H7	9006XS																																																																		
H8	9007 / HB5																																																																		
H1 100WTB																																																																			
H3 100WTB																																																																			
H3 130WTB																																																																			
9004 100/80WTB																																																																			
9005 100WTB																																																																			
9006 80WTB																																																																			
9007 100/80WTB																																																																			
H4 100/55WTB																																																																			
H4 100/80WTB																																																																			
H4 130/90WTB																																																																			
H7 100WTB																																																																			
H11 24V DP																																																																			



10 **GLOVE BOX LIGHT**

2825 W5W	7440 C5W	5007 R5W

9 **TRUNK LIGHT**

5007 R5W	7440 C5W	6411 10W	6411 LED

7 **INTERIOR LIGHT**







7440 H6W	7443 R5W	5008 R10W	6413 C5W	2825 W5W	6428 M Bulb	921 LED	6411 LED	6418 LED

8 **STOP LIGHT**

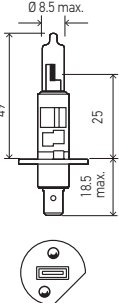
7537 P21/5W	7225 P21/4W	7506 P21W	7440 W21W	7443 W21/5W	5007 R5W

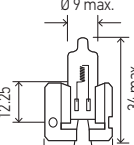
PRODUCT RANGE

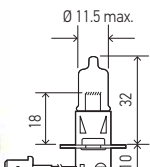
HALOGEN BULBS SUMMARY

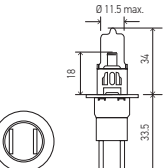
Product Image / Dimensions	Part Number	Voltage	Wattage	Base	Shape	Luminous Flux (lumens)	Kelvin	Content	Packaging	DOT	ECE	INMETRO	Features
 	H1	12	55 W	P14.5s	T2.5	1550		1	C	■	■	■	Standard
	H1 24V	24	70 W	P14.5s	T2.5	1900		1	C		■	■	Standard
	H1P50	12	55 W	P14.5s	T2.5	1700		1	C	■	■	■	+ 50
	◆ H1P50TB	12	55 W	P14.5s	T2.5	1700		2	B	■	■	■	+ 50
	◆ H1 24V DP	24	70 W	P14.5s	T2.5	1900		1	C		■	■	Double Power
	H1 100W	12	100 W	P14.5s	T2.5	1850		1	C				High Wattage
	H1 130W	12	130 W	P14.5s	T2.5	2400		1	C				High Wattage
	◆ H1 2.0TB	12	55 W	P14.5s	T2.5	1550	3600	2	B	■	■	■	High Performance 2.0
	H1LL	12	55 W	P14.5s	T2.5	1550		1	C	■	■	■	Long Life
	H1 YL	12	55 W	P14.5s	T2.5	1550	2900	2	B				Xtreme Yellow
	H71070227*	12	100 W	P14.5s	T2.5			2	P				Extreme White XB
	H71071242*	12	55 W	P14.5s	T2.5			2	P				Extreme White XB
	H71070642*	12	55 W	P14.5s	T2.5			2	P				Extreme Yellow XY
	◆ H1TB	12	55 W	P14.5s	T2.5	1550		2	B	■	■	■	Standard
	◆ H1SB	12	55 W	P14.5s	T2.5	1550		1	B	■	■	■	Standard
	◆ H1 100WTB	12	100 W	P14.5s	T2.5	1850		2	B				High Wattage
	◆ H1 24VSB	24	70 W	P14.5s	T2.5			1	B		■	■	Standard
	◆ H1 24VTB	24	70 W	P14.5s	T2.5			2	B		■	■	Standard
◆ H1 24V DPSB	24	70 W	P14.5s	T2.5			1	B		■	■	Double Power	
LOW BEAM, HIGH BEAM, FOG LIGHT (WHERE APPLICABLE)													
 	H2	12	55 W	X511	T3			1	C			■	Standard
	H2 100W	12	100 W	X511	T3			1	C				High Wattage
LOW BEAM, HIGH BEAM, FOG LIGHT (WHERE APPLICABLE)													
   H3 BULLET	H3	12	55 W	PK22s	T3.25	1450		1	C	■	■	■	Standard
	H3 BULLET	12	55 W	PK22s	T3.25	1450		1	C				Standard
	H3 35W	12	35 W	PK22s	T3.25	750		1	C				Standard
	H3 24V	24	70 W	PK22s	T3.25	1750		1	C		■	■	Standard
	H3P50	12	55 W	PK22s	T3.25	1600		1	C				+ 50
	◆ H3P50TB	12	55 W	PK22s	T3.25	1600		2	B				+ 50
	H3XE-100CB	12	100 W	PK22s	T3.25	1600	3600	1	C				Clear Blue/High W
	H3 24V DP	24	70 W	PK22s	T3.25			1	C		■	■	Double Power
	H3 24V HD	24	70 W	PK22s	T3.25	1750		1	C		■	■	Heavy Duty
	◆ H3HD	12	55 W	PK22s	T3.25	1450		1	C	■	■	■	Heavy Duty
	H3 100W	12	100W	PK22s	T3.25	1850		1	C				High Wattage
	H3 130W	12	130 W	PK22s	T3.25	2600		1	C				High Wattage
	H3 24V 100W	24	100 W	PK22s	T3.25	2500		1	C				High Wattage
	◆ H3 100WTB	12	100 W	PK22s	T3.25	1850		2	B				High Wattage
	◆ H3 130WTB	12	130 W	PK22s	T3.25	2600		2	B				High Wattage
	◆ H3 2.0TB	12	55 W	PK22s	T3.25	1450	3600	2	B	■	■	■	High Performance 2.0
	H3 YL	12	55 W	PK22s	T3.25	1450	2900	2	B				Xtreme Yellow
	H71070181*	12	100 W	PK22s	T3.25			2	P				Extreme White XB
	H71071312*	12	55 W	PK22s	T3.25			2	P				Extreme White XB
	H71070662*	12	55 W	PK22s	T3.25			2	P				Extreme Yellow XY
	◆ H3TB	12	55 W	PK22s	T3.25	1450		2	B	■	■	■	Standard
	◆ H3 35WTB	12	35 W	PK22s	T3.25	750		2	B				Standard
	◆ H3SB	12	55 W	PK22s	T3.25	1450		1	B	■	■	■	Standard
◆ H3 35WSB	12	35 W	PK22s	T3.25	750		1	B				Standard	
◆ H3 24V DPSB	24	70 W	PK22s	T3.25			1	B		■	■	Double Power	
◆ H3 24V HDSB	24	70 W	PK22s	T3.25			1	B		■	■	Heavy Duty	
◆ H3 24VSB	24	70 W	PK22s	T3.25			1	B		■	■	Standard	
◆ H3 24V 100WTB	24	100 W	PK22s	T3.25			2	B				High Wattage	
◆ H3 24V HDTB	24	70 W	PK22s	T3.25			2	B		■	■	Heavy Duty	
◆ H3 24VTB	24	70 W	PK22s	T3.25			2	B		■	■	Standard	
LOW BEAM, HIGH BEAM, FOG LIGHT (WHERE APPLICABLE)													
 	H71071322*	12	55 W	P22d	T3.25			2	P				Extreme White XB
	H71071332*	12	80 W	P22d	T3.25			2	P				Extreme White XB
	H71071342*	12	55 W	P22d	T3.25			2	P				Extreme Yellow XY
LOW BEAM, HIGH BEAM, FOG LIGHT (WHERE APPLICABLE)													

C = Box B = Blister Pack P = Plastic Case
 * = OPTILUX Product Range ◆ = New Product

Measures in millimeters

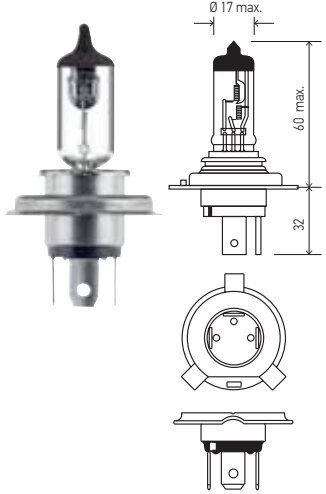
Product Image / Dimensions	Part Number	Voltage	Wattage	Base	Shape	Luminous Flux (lumens)	Kelvin	Content	Packaging	DOT	ECE	INMETRO	Features
H4 	H4	12	60/55 W	P43t	T4.625	1650/1000	3200	1	C		■	■	Standard
	H4 24V	24	75/70 W	P43t	T4.625	1900/1200		1	C		■	■	Standard
	H4 35/35W	12	35/35 W	P43t	T4.625	825/525		1	C				Standard
	H4 45/45W	12	45/45 W	P43t	T4.625			1	C				Standard
	H4 P45T	12	60/55 W	P45t	T4.625	1650/1000		1	C				Standard
	H4P50	12	60/55 W	P43t	T4.625	1815/1100		1	C		■	■	+ 50
	◆ H4P50TB	12	60/55 W	P43t	T4.625	1815/1100		2	B		■	■	+ 50
	H4XE-CB	12	60/55 W	P43t	T4.625	1650/1000	3600	1	C				Clear Blue
	H4XE-100CB	12	100/80 W	P43t	T4.625	2000/1350	3600	1	C				Clear Blue/High W
	◆ H4 24V DP	24	75/70 W	P43t	T4.625	1900/1200		1	C		■	■	Double Power
	H4 24V HD	24	75/70 W	P43t	T4.625	1900/1200		1	C		■	■	Heavy Duty
	H4 100/55W	12	100/55 W	P43t	T4.625	2400/1000		1	C				High Wattage
	H4 100/80W	12	100/80 W	P43t	T4.625			1	C				High Wattage
	H4 130/90W	12	130/90 W	P43t	T4.625	3200/1600		1	C				High Wattage
	H4 24V 100/90W	24	100/90 W	P43t	T4.625			1	C				High Wattage
	◆ H4 100/55WTB	12	100/55 W	P43t	T4.625	2400/1000		2	B				High Wattage
	◆ H4 100/80WTB	12	100/80 W	P43t	T4.625			2	B				High Wattage
	◆ H4 130/90WTB	12	130/90 W	P43t	T4.625	3200/1600		2	B				High Wattage
	◆ H4 100/80WSB	12	100/80 W	P43t	T4.625			1	B				High Wattage
	◆ H4 24V LL	24	75/70 W	P43t	T4.625	1900/1200		1	C				Long Life
	H4 YL	12	60/55 W	P43t	T4.625	1650/1000	2800	2	P				Xtreme Yellow
	H71070201*	12	100/80 W	P43t	T4.625			2	P				Extreme White XB
	H71071352*	12	60/55 W	P43t	T4.625			2	P				Extreme White XB
	H71070682*	12	60/55 W	P43t	T4.625			2	P				Extreme Yellow XY
	◆ H4TB	12	60/55 W	P43t	T4.625	1650/1000	3200	2	B		■	■	Standard
	◆ H4 35/35WTB	12	35 /35 W	P43t	T4.625			2	B				Standard
	◆ H4 45/45WTB	12	45 /45 W	P43t	T4.625			2	B				Standard
	◆ H4 P45TTB	12	60/55 W	P45t	T4.625			2	B				Standard
	◆ H4SB	12	60/55 W	P43t	T4.625	1650/1000	3200	1	B		■	■	Standard
	◆ H4 35/35WSB	12	35 /35 W	P43t	T4.625			1	B				Standard
◆ H4 45/45WSB	12	45 /45 W	P43t	T4.625			1	B				Standard	
◆ H4 P45TSB	12	60/55 W	P45t	T4.625	1650/1000		1	B				Standard	
◆ H424V 100/90WTB	24	100/90 W	P43t	T4.625			2	B				High Wattage	
◆ H4 24V HDTB	24	75/70 W	P43t	T4.625			2	B		■	■	Heavy Duty	
◆ H4 24VTB	24	75/70 W	P43t	T4.625			2	B		■	■	Standard	
◆ H4 24V DPSB	24	75/70 W	P43t	T4.625			1	B		■	■	Double Power	
◆ H4 24V HDSB	24	75/70 W	P43t	T4.625			1	B		■	■	Heavy Duty	
◆ H4 24VSB	24	75/70 W	P43t	T4.625			1	B		■	■	Standard	



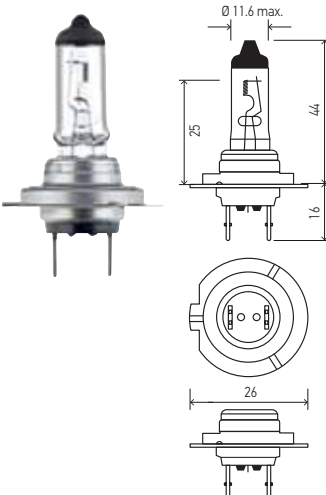



LOW BEAM, HIGH BEAM, FOG LIGHT (WHERE APPLICABLE)

H7 	H7	12	55 W	PX26d	T4.625	1350		1	C	■	■	■	Standard
	H7 24V	24	70 W	PX26d	T4.625	1750		1	C		■	■	Standard
	H7P50	12	55 W	PX26d	T4.625	1560		1	C	■	■	■	+ 50
	◆ H7P50TB	12	55 W	PX26d	T4.625	1560		2	B	■	■	■	+ 50
	◆ H7 24V DP	24	70 W	PX26d	T4.625			1	C		■	■	Double Power
	H7 70W	12	70 W	PX26d	T4.625	1800		1	C				High Wattage
	H7 100W	12	100 W	PX26d	T4.625	2000		1	C				High Wattage
	◆ H7 100WTB	12	100 W	PX26d	T4.625	2000		2	B				High Wattage
	◆ H7 2.0TB	12	55 W	PX26d	T4.625	1500		2	P		■	■	High Performance 2.0
	H7 24V LL	24	70 W	PX26d	T4.625	1750		1	C		■	■	Long Life
	H7LL	12	55 W	PX26d	T4.625	1500	3700	1	C	■	■	■	Long Life
	H7 YL	12	55 W	PX26d	T4.625	1500		2	P				Xtreme Yellow
	H71070307*	12	100 W	PX26d	T4.625			2	P				Extreme White XB
	H71071362*	12	55 W	PX26d	T4.625			2	P				Extreme White XB
	H71070702*	12	55 W	PX26d	T4.625			2	P				Extreme Yellow XY
	◆ H7TB	12	55 W	PX26d	T4.625	1350		2	B	■	■	■	Standard
	◆ H7SB	12	55 W	PX26d	T4.625	1350		1	B	■	■	■	Standard
◆ H7 24VSB	24	70 W	PX26d	T4.625			1	B		■	■	Standard	
◆ H7 24VTB	24	70 W	PX26d	T4.625			2	B		■	■	Standard	
◆ H7 24V DPSB	24	70 W	PX26d	T4.625			1	B		■	■	Double Power	

LOW BEAM, HIGH BEAM, FOG LIGHT (WHERE APPLICABLE)





PRODUCT RANGE

HALOGEN BULBS SUMMARY

Product Image / Dimensions	Part Number	Voltage	Wattage	Base	Shape	Luminous Flux (lumens)	Kelvin	Content	Packaging	DOT	ECE	INMETRO	Features
H8  	H8	12	35 W	PGJ19-1	T4	800		1	C	■	■		Standard
	H71070772*	12	55 W	PGJ19-1	T4			2	P				Extreme White XB
	H71071072*	12	35 W	PGJ19-1	T4			2	P				Extreme Yellow XY
	H71071372*	12	35 W	PGJ19-1	T4			2	P				Extreme White XB
	◆ H8TB	12	35 W	PGJ19-1	T4	800		2	B	■	■		Standard
	◆ H8SB	12	35 W	PGJ19-1	T4	800		1	B	■	■		Standard
	◆ H8B	12	35 W	PGJ19-1	T4	800		1	C		■		Standard
LOW BEAM, HIGH BEAM, FOG LIGHT (WHERE APPLICABLE)													
H9  H9B 	H9	12	65 W	PGJ19-5	T4	2100		1	C	■	■		Standard
	H9 2.0TB	12	65 W	PGJ19-5	T4	2100	3700	2	P	■	■		High Performance 2.0
	◆ H71070792*	12	100 W	PGJ19-5	T4			2	P				Extreme White XB
	H71071092*	12	65 W	PGJ19-5	T4			2	P				Extreme Yellow XY
	H71071382*	12	65 W	PGJ19-5	T4			2	P				Extreme White XB
	◆ H9TB	12	65 W	PGJ19-5	T4	2100		2	B	■	■		Standard
	◆ H9SB	12	65 W	PGJ19-5	T4	2100		1	B				Standard
◆ H9 24VSB	24	80 W	PGJ19-5	T4			1	B				Standard	
◆ H9 24VTB	24	80 W	PGJ19-5	T4			2	B				Standard	
◆ H9B	12	65 W	PGJ19-5	T4	2100		1	C		■		Standard	
HIGH BEAM, WORK LIGHT													
H10 	H10	12	45 W	PY20d	T4	850		1	C		■		Standard
	H71071012*	12	65 W	PY20d	T4			2	P				Extreme White XB
	H71071112*	12	42 W	PY20d	T4			2	P				Extreme Yellow XY
	H71071252*	12	42 W	PY20d	T4			2	P				Extreme White XB
	◆ H10TB	12	45 W	PY20d	T4	850		2	B		■		Standard
◆ H10SB	12	45 W	PY20d	T4	850		1	B		■		Standard	
LOW BEAM													
H11 	H11	12	55 W	PGJ19-2	T4	1350		1	C	■	■		Standard
	H11 24V	24	70 W	PGJ19-2	T4	1600		1	C		■		Standard
	H11P50	12	55 W	PGJ19-2	T4	1450		1	C	■	■		+ 50
	◆ H11P50TB	12	55 W	PGJ19-2	T4	1450		2	B				+ 50
	H11XE-CB	12	55 W	PGJ19-2	T4	1350	3600	1	C				Clear Blue
	◆ H11 24V DP	24	70 W	PGJ19-2	T4			1	C		■		Double Power
	◆ H11 2.0TB	12	55 W	PGJ19-2	T4	1350	3700	2	P	■	■		High Performance 2.0
	H11LL	12	55 W	PGJ19-2	T4	1350		1	C	■	■		Long Life
	H11 YL	12	55 W	PGJ19-2	T4	1450	3000	2	B				Xtreme Yellow
	H71071032*	12	80 W	PGJ19-2	T4			2	P				Extreme White XB
	H71071132*	12	55 W	PGJ19-2	T4			2	P				Extreme Yellow XY
	H71071262*	12	55 W	PGJ19-2	T4			2	P				Extreme White XB
	◆ H11TB	12	55 W	PGJ19-2	T4	1350		2	B	■	■		Standard
◆ H11SB	12	55 W	PGJ19-2	T4	1350		1	B	■	■		Standard	
◆ H11 24V DPSB	24	70 W	PGJ19-2	T4			1	B		■		Double Power	
◆ H11 24VSB	24	70 W	PGJ19-2	T4			1	B		■		Standard	
◆ H11 24VTB	24	70 W	PGJ19-2	T4			2	B		■		Standard	
LOW BEAM													

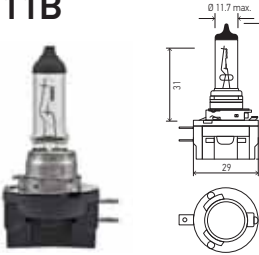
C = Box B = Blister Pack P = Plastic Case
 * = OPTILUX Product Range ◆ = New Product

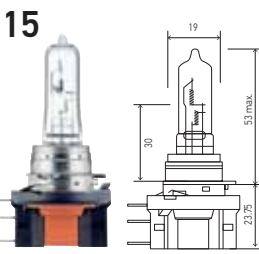

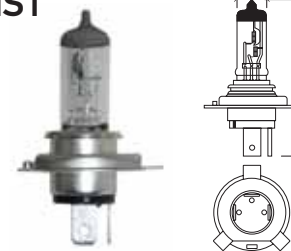
Measures in millimeters

Product Image / Dimensions	Part Number	Voltage	Wattage	Base	Shape	Luminous Flux (lumens)	Kelvin	Content	Packaging	DOT	ECE	INMETRO	Features
H11B 	H11B	12	55 W	PGJY192	T3.25	1345	3100	1	C	■	■		Standard
	LOW BEAM, HIGH BEAM, FOG LIGHT (WHERE APPLICABLE)												
H12 	H12	12	55 W	PZ20d	T4	1050		1	C		■		Standard
	LOW BEAM, HIGH BEAM, FOG LIGHT (WHERE APPLICABLE)												
H13 9008 	H13	12	60/55 W	P26.4t	T4	1700/1100		1	C	■	■		Standard
	H13P50	12	60/55 W	P26.4t	T4	1650/1100		1	C	■	■		+ 50
	H13P50TB	12	60/55 W	P26.4t	T4	1650/1100		2	B	■	■		+ 50
	H13 2.0TB	12	60/55 W	P26.4t	T4	1700/1100	3700	2	P	■	■		High Performance 2.0
	H13 YL	12	60/55 W	P26.4t	T4	1700/1100	3100	2	B				Xtreme Yellow
	H71071052*	12	100/80 W	P26.4t	T4			2	P				Extreme White XB
	H71071272*	12	60/55 W	P26.4t	T4			2	P				Extreme White XB
	H71071152*	12	60/55 W	P26.4t	T4			2	P				Extreme Yellow XY
	H13TB	12	60/55 W	P26.4t	T4	1700/1100		2	B	■	■		Standard
	H13SB*	12	60/55 W	P26.4t	T4	1700/1100		1	B	■	■		Standard
LOW BEAM, HIGH BEAM, FOG LIGHT (WHERE APPLICABLE)													
H15 	H15	12	15/55 W	PGJ23t-1	T4	1330	3100	1	C	■	■		Standard
	FOG LIGHT												
H16 	H16	12	19 W	PGJ19-3	T4		3700	1	C		■		Standard
	H16SB	12	19 W	PGJ19-3	T4		3700	1	B				Standard
FOG LIGHT													
HS1 	HS1	12	35/35 W	PX43t	T4.625			1	C		■		Standard
	HS1TB	12	35/35 W	PX43t	T4.625			2	B		■		Standard
	HS1SB	12	35/35 W	PX43t	T4.625			1	B		■		Standard
LOW BEAM, HIGH BEAM, FOG LIGHT (WHERE APPLICABLE)													

Measures in millimeters

PRODUCT RANGE

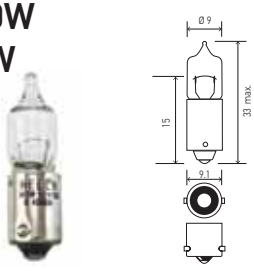
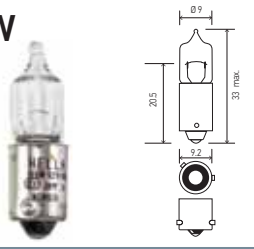
HALOGEN BULBS SUMMARY

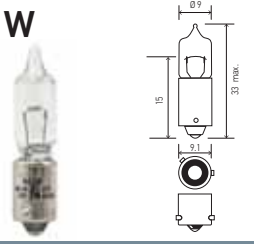
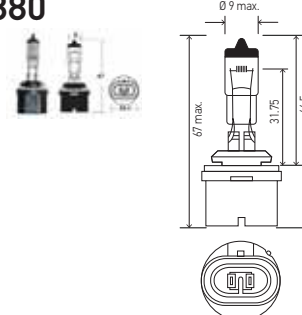
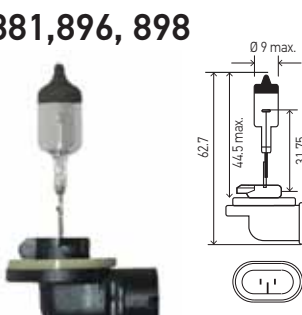
Product Image / Dimensions	Part Number	Voltage	Wattage	Base	Shape	Luminous Flux (lumens)	Kelvin	Content	Packaging	DOT	ECE	INMETRO	Features
H20W H5W 	H20W	12	20 W	BA9s	T2.75	470		1	C				Standard
	H5W	12	5 W	BA9s	T2.75	80		1	C				Standard
FLASHER LIGHT, REAR TURN SIGNAL, FRONT, SIDE AND TAIL LIGHT													
H6W 	H6W	12	6 W	BAX9s	T2.75	125		1	C		■		Standard
	PARKING LIGHT												
H10W 	H10W	12	10 W	BA9s	T2.75			1	C			■	Standard
	PARKING LIGHT												
H21W 	H21W	12	21 W	BAY9s	T2.75	600		1	C		■	■	Standard
	H21W 24V	24	21 W	BAY9s	T2.75			1	C		■	■	Standard
FLASHER LIGHT, REAR TURN SIGNAL, FRONT, SIDE AND TAIL LIGHT													
880 	880	12	27 W	PG13	T3.25	540		1	C		■	■	Standard
	H71071172*	12	27 W	PG13	T3.25			2	P				Extreme Yellow XY
	H71071212*	12	32 W	PG13	T3.25			2	P				Extreme White XB
	880 YL	12	27 W	PG13	T3.25			2	B				Xtreme Yellow
<p>Many bulbs of the 800 series are physically interchangeable but not electrically. Serious damage and blinding by glare can result from misuse of the bulb, so it is important to use only the bulb that is specified for each application.</p>													
LOW BEAM, HIGH BEAM, FOG LIGHT (WHERE APPLICABLE)													
881, 896, 898 	881	12	27 W	PGJ13	T3.25	540		1	C	■	■		Standard
	896	12	37.5 W	PGJ13	T3.25	940	3100	1	C				Standard
	898	12	37.5 W	PGJ13	T3.25	750	3100	1	C				Standard
	H71071182*	12	27 W	PGJ13	T3.25			2	P				Extreme Yellow XY
	H71071222*	12	32 W	PGJ13	T3.25			2	P				Extreme White XB
	<p>Many bulbs of the 800 series are physically interchangeable but not electrically. Serious damage and blinding by glare can result from misuse of the bulb, so it is important to use only the bulb that is specified for each application.</p>												
LOW BEAM, FOG LIGHT (WHERE APPLICABLE)													

C = Box B = Blister Pack P = Plastic Case
 * = OPTILUX Product Range ◆ = New Product

Measures in millimeters

Product Image / Dimensions	Part Number	Voltage	Wattage	Base	Shape	Luminous Flux (lumens)	Kelvin	Content	Packaging	DOT	ECE	INMETRO	Features
----------------------------	-------------	---------	---------	------	-------	------------------------	--------	---------	-----------	-----	-----	---------	----------

884, 885, 887, 890, 892

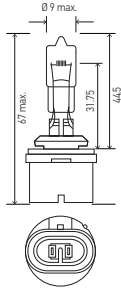

884	12	27 W	PG13	T3.25	540			1	C				Standard
885	12	50 W	PG13	T3.25	1250			1	C				Standard
887	12	50 W	PG13	T3.25	1190			1	C				Standard
890	12	27 W	PG13	T3.25	540	1100		1	C				Standard
892	12	16 W	PG13	T3.25	350			1	C				Standard

Many bulbs of the 800 series are physically interchangeable but not electrically. Serious damage and blinding by glare can result from misuse of the bulb, so it is important to use only the bulb that is specified for each application.

LOW BEAM, FOG LIGHT (WHERE APPLICABLE)

891

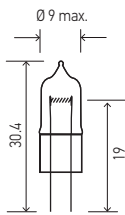

891	12	8 W	G4	T3.25	135	3100		1	C				Standard
------------	----	-----	----	-------	-----	------	--	---	---	--	--	--	----------

LOW BEAM, FOG LIGHT (WHERE APPLICABLE)

893

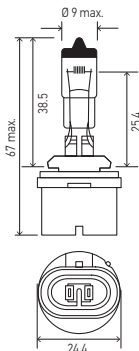

893	12	37.5 W	PG13	T3.25	940			1	C				Standard
H71071192*	12	37.5 W	PG13	T3.25				2	P				Extreme Yellow XY
H71071232*	12	37.5 W	PG13	T3.25				2	P				Extreme White XB

Many bulbs of the 800 series are physically interchangeable but not electrically. Serious damage and blinding by glare can result from misuse of the bulb, so it is important to use only the bulb that is specified for each application.

LOW BEAM, FOG LIGHT (WHERE APPLICABLE)

862, 886, 888, 889, 894

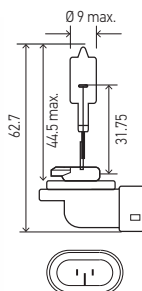

862	12	37.5 W	PGJ13	T3.25	750			1	C				Standard
886	12	50 W	PGJ13	T3.25	1190			1	C				Standard
888	12	50 W	PGJ13	T3.25	540			1	C				Standard
889	12	27 W	PGJ13	T3.25	540			1	C				Standard
889 YL	12	35 W	PGJ13	T3.25				2	B				Xtreme Yellow
894	12	37.5 W	PGJ13	T3.25	940			1	C				Standard

Many bulbs of the 800 series are physically interchangeable but not electrically. Serious damage and blinding by glare can result from misuse of the bulb, so it is important to use only the bulb that is specified for each application.

LOW BEAM, HIGH BEAM, FOG LIGHT (WHERE APPLICABLE)

9003

HB2

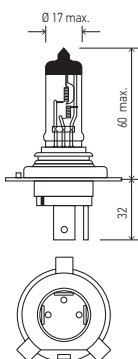







9003	12	60/55 W	P43t	T4.625	1500/910			1	C	■			Standard
9003LL	12	60/55 W	P43t	T4.625	1500/910			1	C	■			Long Life
◆ 9003 2.0TB	12	60/55 W	P43t	T4.625	1500/910	3600		2	P	■	■	■	High Performance 2.0
◆ 9003TB	12	60/55 W	P43t	T4.625	1500/910			2	B	■			Standard
◆ 9003SB	12	60/55 W	P43t	T4.625	1500/910			1	B	■			Standard



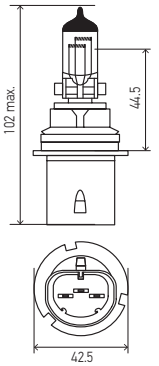

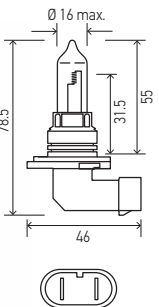

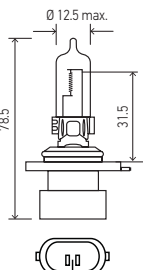

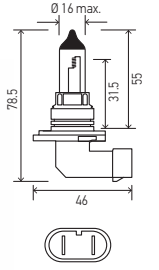
LOW BEAM, HIGH BEAM, FOG LIGHT (WHERE APPLICABLE)

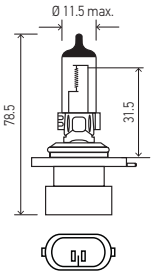
Measures in millimeters

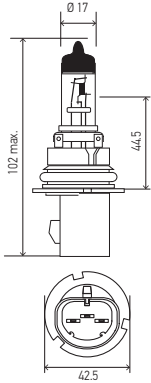
PRODUCT RANGE

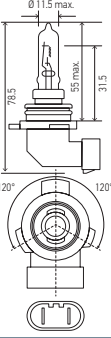
HALOGEN BULBS SUMMARY

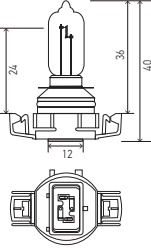

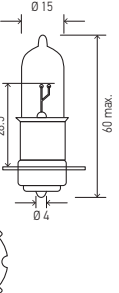

Product Image / Dimensions	Part Number	Voltage	Wattage	Base	Shape	Luminous Flux (lumens)	Kelvin	Content	Packaging	DOT	ECE	INMETRO	Features
 	9004	12	65/45 W	P29t	T4.625	1200/700		1	C	■		■	Standard
	9004P50	12	65/45 W	P29t	T4.625	1250/765		1	C	■		■	+ 50
	◆ 9004P50TB	12	65/45 W	P29t	T4.625	1250/765		2	B	■		■	+50
	9004XE-CB	12	65/45 W	P29t	T4.625	1100/700	3600	1	C				Clear Blue
	9004XE-100CB	12	100/80 W	P29t	T4.625	1250/1100	3600	1	C				Clear Blue/High W
	9004 100/80W	12	100/80 W	P29t	T4.625	1600/1300		1	C				High Wattage
	◆ 9004 100/80WSB	12	100/80 W	P29t	T4.625	1600/1300		2	B				High Wattage
	◆ 9004 2.0TB	12	65/45 W	P29t	T4.625	1200/700	3700	2	P	■		■	High Performance 2.0
	9004LL	12	65/45 W	P29t	T4.625	1200/700		1	C				■ Long Life
	9004 YL	12	65/45 W	P29t	T4.625	1200/700	2800	2	B				Xtreme Yellow
	H71071392*	12	65/45 W	P29t	T4.625			2	P	■			Extreme White XB
	H71070327*	12	100/80 W	P29t	T4.625			2	P				Extreme White XB
	H71070562*	12	65/45 W	P29t	T4.625			2	P				Extreme Yellow XY
	◆ 9004TB	12	65/45 W	P29t	T4.625	1200/700		2	B	■		■	Standard
	◆ 9004SB	12	65/45 W	P29t	T4.625	1200/700		2	B	■		■	Standard
LOW BEAM, HIGH BEAM, FOG LIGHT (WHERE APPLICABLE)													
 	9005	12	65 W	P20d	T4	1860		1	C	■	■	■	Standard
	9005P50	12	65 W	P20d	T4	2000		1	C	■	■	■	+ 50
	◆ 9005P50TB	12	65 W	P20d	T4	2000		2	B	■	■	■	+ 50
	9005XE-100CB	12	100 W	P20d	T4	1530	3600	1	C				Clear Blue/High W
	9005 100W	12	100 W	P20d	T4	2200		1	C				High Wattage
	◆ 9005 100WSB	12	100 W	P20d	T4	2200		2	B				High Wattage
	◆ 9005 2.0TB	12	65 W	P20d	T4	1860	3700	2	P	■	■	■	High Performance 2.0
	9005LL	12	65 W	P20d	T4	1860		1	C	■	■	■	Long Life
	9005 YL	12	65 W	P20d	T4	1860	2900	2	B				Xtreme Yellow
	H71071402*	12	65 W	P20d	T4			2	P				Extreme White XB
	H71070347*	12	100 W	P20d	T4			2	P				Extreme White XB
	H71070582*	12	65 W	P20d	T4			2	P				Extreme Yellow XY
	◆ 9005TB	12	65 W	P20d	T4	1860		2	B	■	■	■	Standard
	◆ 9005SB	12	65 W	P20d	T4	1860		1	B	■	■	■	Standard
	LOW BEAM, HIGH BEAM, FOG LIGHT (WHERE APPLICABLE)												
 	9005XS	12	65 W	P20d	T4	1860		1	C	■	■	■	Standard
	H71071412*	12	65 W	P20d	T4			2	P				Extreme White XB
	H71071422*	12	100 W	P20d	T4			2	P				Extreme White XB
	LOW BEAM, HIGH BEAM, FOG LIGHT (WHERE APPLICABLE)												
 	9006	12	55 W	P22d	T4	1095		1	C	■	■	■	Standard
	9006P50	12	55 W	P22d	T4	1200		1	C	■	■	■	+ 50
	◆ 9006P50TB	12	55 W	P22d	T4	1200		2	B	■	■	■	+ 50
	9006XE-80CB	12	80 W	P22d	T4	1300	3600	1	C				Clear Blue/High W
	9006 80W	12	80 W	P22d	T4	1650		1	C				High Wattage
	◆ 9006 80WSB	12	80 W	P22d	T4	1650		2	B				High Wattage
	◆ 9006 2.0TB	12	55 W	P22d	T4	1095	3700	2	P	■	■	■	High Performance 2.0
	9006LL	12	55 W	P22d	T4	1095		1	C	■	■	■	Long Life
	9006 YL	12	55 W	P22d	T4	1095	2900	2	B				Xtreme Yellow
	H71071432*	12	55 W	P22d	T4			2	P				Extreme White XB
	H71070367*	12	80 W	P22d	T4			2	P				Extreme White XB
	H71070602*	12	55 W	P22d	T4			2	P				Extreme Yellow XY
	◆ 9006TB	12	55 W	P22d	T4	1095		2	B	■	■	■	Standard
	◆ 9006SB	12	55 W	P22d	T4	1095		1	B	■	■	■	Standard
	LOW BEAM, HIGH BEAM, FOG LIGHT (WHERE APPLICABLE)												

Product Image / Dimensions	Part Number	Voltage	Wattage	Base	Shape	Luminous Flux (lumens)	Kelvin	Content	Packaging	DOT	ECE	INMETRO	Features
9006XS HB4A  	9006XS	12	55 W	P22d	T4	1095		1	C	■	■	■	Standard
	H71071442*	12	55 W	P22d	T4			2	P				Extreme White XB
	H71071452*	12	80 W	P22d	T4			2	P				Extreme White XB
	H71071462*	12	55 W	P22d	T4			2	P				Extreme Yellow XY
	LOW BEAM, HIGH BEAM, FOG LIGHT (WHERE APPLICABLE)												
9007 HB5  	9007	12	65/55 W	PX29t	T4.625	1350/1000		1	C	■			Standard
	9007P50	12	65/55 W	PX29t	T4.625	1450/1100		1	C	■			+ 50
	◆ 9007P50TB	12	65/55 W	PX29t	T4.625	1450/1100		2	B	■			+ 50
	9007XE-CB	12	65/55 W	PX29t	T4.625	1350/1000	3700	1	C				Clear Blue
	9007 100/80W	12	100/80 W	PX29t	T4.625	1800/1500		1	C				High Wattage
	◆ 9007 100/80WSB	12	100/80 W	PX29t	T4.625	1800/1500		2	B	■			High Wattage
	◆ 9007 2.0TB	12	65/55 W	PX29t	T4.625	1350/1000	3700	2	P	■			High Performance 2.0
	9007LL	12	65/55 W	PX29t	T4.625	1350/1000		1	C				Long Life
	9007 YL	12	65/55 W	PX29t	T4.625	1350/1000	2800	2	B				Xtreme Yellow
	H71071472*	12	65/55 W	PX29t	T4.625			2	P				Extreme White XB
	H71070387*	12	100/80 W	PX29t	T4.625			2	P				Extreme White XB
	H71070622*	12	60/55 W	PX29t	T4.625			2	P				Extreme Yellow XY
	◆ 9007TB	12	60/55 W	PX29t	T4.625	1350/1000		2	B				Standard
◆ 9007SB	12	60/55 W	PX29t	T4.625	1350/1000		1	B				Standard	
LOW BEAM, HIGH BEAM, FOG LIGHT (WHERE APPLICABLE)													
HIR2 9012  	◆ 9012LL	12	55 W	PX22d	T4			1	C	■			Long Life
	LOW BEAM, HIGH BEAM												
9009S  	H71071282*	12	35 W	PG20-3	T4			2	P				Extreme White XB
	H71071302*	12	35 W	PG20-3	T4			2	P				Extreme Yellow XY
	LOW BEAM, HIGH BEAM, FOG LIGHT (WHERE APPLICABLE)												
M5  	◆ M5 35/35W	12	35/35 W	P15d-25-1		840/805		1	C				Standard
	◆ M5 35/35WTB	12	35/35 W	P15d-25-1		840/805		2	B				Standard
	◆ M5 35/35WSB	12	35/35 W	P15d-25-1		840/805		1	B				Standard
	◆ M5 35/35W1	12	35/35 W	BA20D		840/805		1	C	■			Standard
	◆ M5 25/25W	12	25/25 W	BA20D		540/540		1	C	■			Standard
	◆ M5 25/25W1	12	25/25 W	P15D-25-1		540/540		1	C	■			Standard
	◆ M5 18/18W	12	18/18 W	P15D-25-1		440/440		1	C	■			Standard
	◆ M5 35/35W3	12	35/35 W	P15D-25-3		840/805		1	C	■			Standard
	◆ M5 25/25W3	12	25/25 W	P15D-25-3		540/540		1	C	■			Standard
	LOW BEAM, HIGH BEAM, FOG LIGHT (WHERE APPLICABLE)												

Measures in millimeters

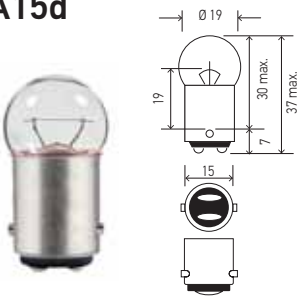
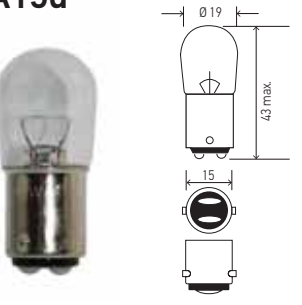
PRODUCT RANGE

MINIATURE BULBS SUMMARY

Product Image / Dimensions	Part Number	Voltage	Wattage	Base	Shape	Luminous Flux (lumens)	Kelvin	Content	Packaging	DOT	ECE	INMETRO	Features
BA15d 	90	12	8 W	BA15d	G6	125		10	C	■			Standard
	1224	32	5 W	BA15d	G6	125		10	C	■			Standard
STOP LIGHT, REAR POSITION LIGHT													
BA15d 	1004	12	12.8 W	BA15d	B6			10	C	■			Standard
	PARKING LIGHT, LICENSE PLATE LIGHT, GLOVE COMPARTMENT LIGHT, TRUNK LIGHT												
BA15d 	1176	12	17/8 W	BA15d	S8			10	C	■			Standard
	◆ 1176A	12	16/8 W	BA15d	S8			10	C	■			Standard (Amber)
	◆ 7240	12	21/5 W	BA15d	S8			10	C				Standard
	◆ 7533	12	15 W	BA15d	S8			10	C				Standard
	◆ 7534	24	21/5 W	BA15d	S8			10	C				Standard
	◆ 7534TB	24	21/5 W	BA15d	S8			2	B				Standard
	STOP LIGHT, REAR POSITION LIGHT												
BA15s 	63	6	4 W	BA15s	G6			10	C	■			Standard
	631	12	9 W	BA15s	G6			10	C	■			Standard
	67	12	8 W	BA15s	G6			10	C	■			Standard
	89	12	8 W	BA15s	G6			10	C	■			Standard
	◆ 97	12	9 W	BA15s	G6			10	C	■			Standard
PARKING LIGHT, LICENSE PLATE LIGHT													
BA15s 	5007	12	5 W	BA15s	B6			10	C	■	■		Standard
	◆ 5007TB	12	5 W	BA15s	B6			2	B		■	■	Standard
	◆ 5007SB	12	5 W	BA15s	B6			1	B		■	■	Standard
	5008	12	10 W	BA15s	B6			10	C		■	■	Standard
	◆ 5008TB	12	10 W	BA15s	B6			2	B		■	■	Standard
	◆ 5008SB	12	10 W	BA15s	B6			1	B		■	■	Standard
	5627	24	5 W	BA15s	B6			10	C		■	■	Standard
	◆ 5627SB	24	5 W	BA15s	B6			1	B		■	■	Standard
	◆ 5627TB	24	5 W	BA15s	B6			2	B		■	■	Standard
	◆ 5637	24	10 W	BA15s	B6			10	C		■	■	Standard
	5637TB	24	10 W	BA15s	B6			2	B		■	■	Standard
	5637HD	24	10 W	BA15s	B6			10	C		■	■	Heavy Duty
	PARKING LIGHT, LICENSE PLATE LIGHT												

C = Box B = Blister Pack P = Plastic Case
 * = OPTILUX Product Range ◆ = New Product

Measures in millimeters

Product Image / Dimensions	Part Number	Voltage	Wattage	Base	Shape	Luminous Flux (lumens)	Kelvin	Content	Packaging	DOT	ECE	INMETRO	Features
BA15s 	1003	12	12 W	BA15s	B6			10	C	■			Standard
	1003LL	12	12 W	BA15s	B6			10	C	■			Long Life
	1308	24	16 W	BA15s	B6					■			Standard
PARKING LIGHT, LICENSE PLATE LIGHT, GLOVE COMPARTMENT LIGHT, TRUNK LIGHT													

BA15s 	3497	12	25 W	BA15s	T6			10	C	■			Standard
	PARKING LIGHT, LICENSE PLATE LIGHT, GLOVE COMPARTMENT LIGHT, TRUNK LIGHT												

BA15s P21W PY21W 	93	12	13 W	BA15s	S8			10	C	■			Standard
	199	12	29 W	BA15s	S8			10	C	■			Standard (35 MSCP)
	1073	12	23 W	BA15s	S8			10	C	■			Standard
	1141	12	18 W	BA15s	S8			10	C	■			Standard
	◆ 1141TB	12	18 W	BA15s	S8			2	B	■			Standard
	◆ 1141 24V	24	18 W	BA15s	S8			10	C	■			Standard
	◆ 1141 24VSB	24	18 W	BA15s	S8			1	B				Standard
	◆ 1141 24VTB	24	18 W	BA15s	S8			2	B				Standard
	1141LL	12	18 W	BA15s	S8			10	C	■			Long Life
	1156	12	27 W	BA15s	S8			10	C	■			Standard
	1156LL	12	27 W	BA15s	S8			10	C	■			Long Life
	1156NA	12	27 W	BA15s	S8			10	C	■			Standard (Nat. amber)
	1683	24	29 W	BA15s	S8			10	C	■			Standard
	2396	12	29 W	BA15s	S8			10	C	■			Standard (40 MSCP)
	7506A	12	21 W	BA15s	S8			10	C			■	Standard (Amber)
	◆ 7506	12	21 W	BA15s	S8			10	C		■		Standard
	◆ 7506TB	12	21 W	BA15s	S8			2	B		■	■	Standard
	7506ATB	12	21 W	BA15s	S8			2	B		■	■	Standard
	◆ 7511	24	21 W	BA15s	S8			10	C		■	■	Standard
	◆ 7511TB	24	21 W	BA15s	S8			2	B		■	■	Standard
7511SB	24	21 W	BA15s	S8			1	B		■	■	Standard	
7506NA	12	21 W	BA15s	S8			10	C				Standard (Nat. amber)	
FLASHING LIGHT, STOP LIGHT, REAR FOG LIGHT, REVERSE LIGHT, SIGNAL LIGHT													

BA20d S2 	6235	12	35/35 W	BA20d	B11			1	C		■		Standard
	◆ 6235SB	12	35/35 W	BA20d	B11			1	B				Standard
	6245	12	45/40 W	BA20d	B11			1	C				Standard
	6260	12	60/60 W	BA20d	B11			1	C				Standard (High W.)
LOW BEAM, HIGH BEAM													

Measures in millimeters

PRODUCT RANGE

MINIATURE BULBS SUMMARY

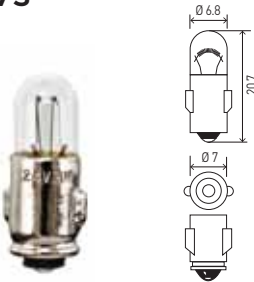
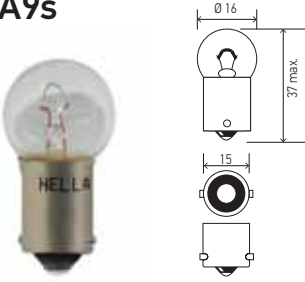
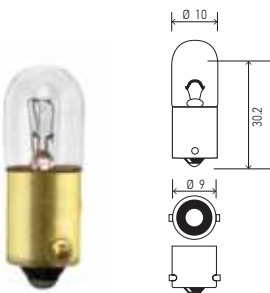
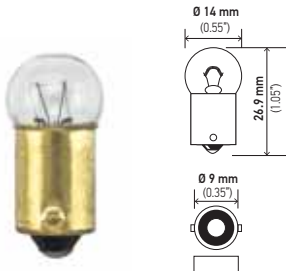
Product Image / Dimensions	Part Number	Voltage	Wattage	Base	Shape	Luminous Flux (lumens)	Kelvin	Content	Packaging	DOT	ECE	INMETRO	Features
BA20s 	660	12	60 W	BA20s	B11			1	C				Standard (High W.)
	635	12	35 W	BA20s	B11			1	C				Standard
LOW BEAM, HIGH BEAM													
BA7s 	3799	6	1 W	BA7s	T2			10	C				Standard
	3898	12	2 W	BA7s	T2			10	C				Standard
	3898TB	12	2 W	BA7s	T2			2	B				Standard
	3899	24	3 W	BA7s	T2			10	C				Standard
DASHBOARD LIGHT													
BA9s 	51	6	12 W	BA9s	G3.5			10	C	■			Standard
	53	12	2 W	BA9s	G3.5			10	C	■			Standard
	53TB	12	2 W	BA9s	G3.5			2	B				Standard
	57	12	3 W	BA9s	G4.5			10	C	■		■	Standard
	265	24	2 W	BA9s	G3.5			10	C	■			Standard
	1445	12	2 W	BA9s	G3.5			10	C	■			Standard
PARKING LIGHT, DASHBOARD LIGHT													
BA9s 	1816	12	4 W	BA9s	T3.25			10	C	■			Standard
	1891	12	3 W	BA9s	T3.25			10	C	■			Standard
	1893	12	5 W	BA9s	T3.25			10	C	■			Standard
PARKING LIGHT													
BA9s 	1895	12	4 W	BA9s	G4.5			10	C	■			Standard
PARKING LIGHT, DASHBOARD LIGHT													

C = Box B = Blister Pack P = Plastic Case
 * = OPTILUX Product Range ◆ = New Product

Measures in millimeters

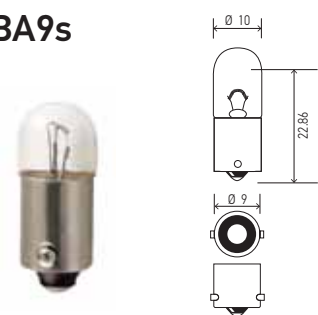
Product Image / Dimensions	Part Number	Voltage	Wattage	Base	Shape	Luminous Flux (lumens)	Kelvin	Content	Packaging	DOT	ECE	INMETRO	Features
BA9s 	3796	12	2 W	BA9s	T2.75			10	C			■	Standard
	3797	24	2 W	BA9s	T2.75			10	C				Standard
	◆ 3797TB	24	2 W	BA9s	T2.75			2	B				Standard
	3893	12	4 W	BA9s	T2.75			10	C	■	■		Standard
	3893TB	12	4 W	BA9s	T2.75			2	B	■	■		Standard
	◆ 3893SB	12	4 W	BA9s	T2.75			1	B	■	■		Standard
	3930	24	4 W	BA9s	T2.75			10	C	■	■		Standard
	◆ 3930TB	24	4 W	BA9s	T2.75			2	B	■	■		Standard
	PARKING LIGHT												

BAU15s P21W PY21W 	7507C	12	21 W	BAU15s	S8			10	C				Standard
	◆ 7507CTB	12	21 W	BAU15s	S8			2	B				Standard
	7507	12	21 W	BAU15s	S8			10	C		■	■	Standard
	◆ 7507TB	12	21 W	BAU15s	S8			2	B		■	■	Standard
	7510LTS	24	21 W	BAU15s	S8			10	C				Heavy Duty
	◆ 7510LSTB	24	21 W	BAU15s	S8			2	B				Standard
	9507	24	21 W	BAU15s	S8			10	C		■	■	Standard (Amber)
	◆ 9507TB	24	21 W	BAU15s	S8			2	B		■	■	Standard (Amber)
	◆ 5009	12	10 W	BAU15s	S8			10	C				Standard
	FLASHING LIGHT AND FRONT, REAR SIDE SIGNAL LIGHT												

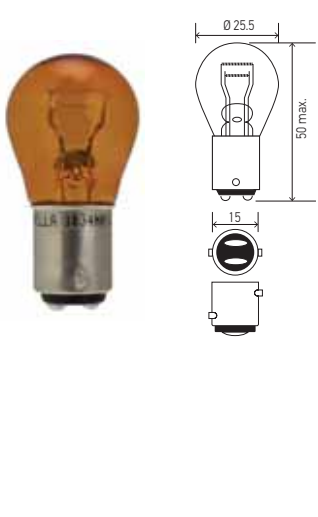

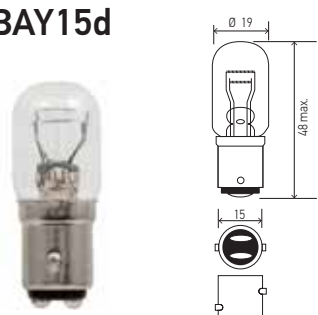

BAY15d 	198HD	12	29/10 W	BAY15d	S8			10	C	■			Heavy Duty	
	1034	12	23/8 W	BAY15d	S8			10	C	■			Standard	
	1034A	12	23/8 W	BAY15d	S8			10	C	■			Standard (Amber)	
	1034NA	12	23/8 W	BAY15d	S8			10	C	■			Standard (Nat. amber)	
	◆ 1034TB	12	23/8 W	BAY15d	S8			2	B	■			Standard	
	1157	12	27/8 W	BAY15d	S8			10	C	■			Standard	
	◆ 1157TB	12	27/8 W	BAY15d	S8			2	B	■			Standard	
	1157LL	12	27/8 W	BAY15d	S8			10	C	■			Long Life	
	◆ 1157A	12	27/8 W	BAY15d	S8			10	C	■			Standard	
	1157NA	12	27/8 W	BAY15d	S8			10	C	■			Standard (Nat. amber)	
	2057	12	27/7 W	BAY15d	S8			10	C	■			Standard	
	2057LL	12	27/7 W	BAY15d	S8			10	C	■			Long Life	
	2057NA	12	27/7 W	BAY15d	S8			10	C	■			Standard (Nat. amber)	
	2057NALL	12	27/7 W	BAY15d	S8			10	C	■			Long Life (Nat. amber)	
	2357	12	29/8 W	BAY15d	S8			10	C	■			Standard	
	2357LL	12	29/8 W	BAY15d	S8			10	C	■			Long Life	
	2357NA	12	29/8 W	BAY15d	S8			10	C	■			Standard (Nat. amber)	
	2397	12	29/8 W	BAY15d	S8			10	C	■			Standard	
	STOP LIGHT, REAR POSITION LIGHT													

BAY15d 	3496	12	27/8 W	BAY15d	T6			10	C	■			Standard
	LOW BEAM, HIGH BEAM, FOG LIGHT (WHERE APPLICABLE)												

Measures in millimeters

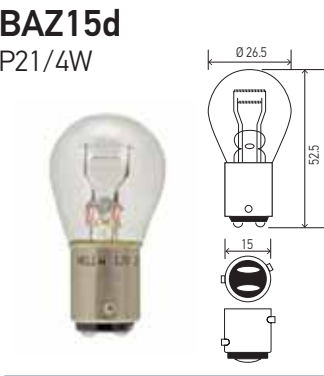

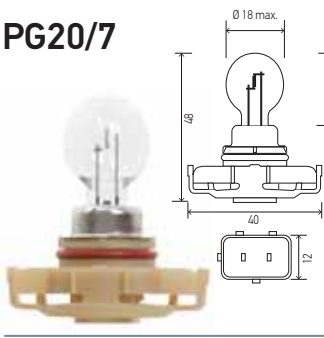



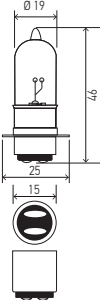

PRODUCT RANGE

MINIATURE BULBS SUMMARY

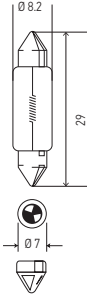
Product Image / Dimensions	Part Number	Voltage	Wattage	Base	Shape	Luminous Flux (lumens)	Kelvin	Content	Packaging	DOT	ECE	INMETRO	Features
BAY15d 	7528	12	21/5 W	BAY15d	S8			10	C	■	■		Standard
	7537	24	21/5 W	BAY15d	S8			10	C				Standard
	◆ 7537SB	24	21/5 W	BAY15d	S8			1	B	■	■		Standard
	◆ 7537TB	24	21/5 W	BAY15d	S8			2	B	■	■		Standard
	7528TB	12	21/5 W	BAY15d	S8			2	B				Standard
	7528SB	12	21/5 W	BAY15d	S8			1	B				Standard
	STOP LIGHT, REAR POSITION LIGHT												
BAZ15d P21/4W 	7225	12	21/4 W	BAZ15d	S8			10	C	■	■		Standard
	◆ 7225TB	12	21/4 W	BAZ15d	S8			2	B	■	■		Standard
POSITION LIGHT, REAR FOG LIGHT, STOP LIGHT													
G4 	JC20	12	20 W	G4	T3			10	C				Standard
	JC5	12	5 W	G4	T3			10	C				Standard
	JC10	12	10 W	G4	T3			10	C				Standard
	LOW BEAM, HIGH BEAM, FOG LIGHT (WHERE APPLICABLE)												
PG20/7 	◆ PSX24W	12	24 W	PG20/7	S8			1	C	■			Standard
	LOW BEAM, HIGH BEAM, FOG LIGHT (WHERE APPLICABLE)												
P45t R2 	7951	12	45/40 W	P45t	S13			10	C	■	■		Standard
	7951 55/50W	12	55/50 W	P45t	S13			10	C				Standard
	7952	24	55/50 W	P45t	S13			10	C				Standard
	◆ 7952TB	24	55/50 W	P45t	S13			2	B				Standard
	LOW BEAM, HIGH BEAM, FOG LIGHT (WHERE APPLICABLE)												

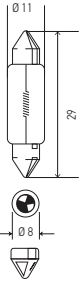
C = Box B = Blister Pack P = Plastic Case
 * = OPTILUX Product Range ◆ = New Product

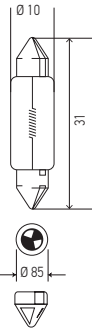

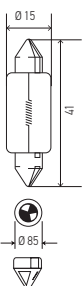



Measures in millimeters

Product Image / Dimensions	Part Number	Voltage	Wattage	Base	Shape	Luminous Flux (lumens)	Kelvin	Content	Packaging	DOT	ECE	INMETRO	Features
PX15d  	A3603	12	25/25 W	PX15d	T6			1	C				Standard
	A3625	6	25/25 W	PX15d	T6			1	C				Standard
LOW BEAM, HIGH BEAM, FOG LIGHT (WHERE APPLICABLE)													
SV7-8  	DE3021	12	3 W	SV7-8	T2.25			10	C	■			Standard (8x29mm)
	◆ DE3021TB	12	3 W	SV7-8	T2.25			2	B	■			Standard (8x29mm)
	◆ DE3021SB	12	3 W	SV7-8	T2.25			1	B	■			Standard (8x29mm)
	DE3022	12	5 W	SV7-8	T2.25			10	C	■			Standard (8x29mm)
PARKING LIGHT, LICENSE PLATE LIGHT, GLOVE COMPARTMENT LIGHT, INTERIOR LIGHT, TRUNK LIGHT													
SV7-8  	6428	12	3 W	SV7-8	T2.5			10	C				Standard (8x28mm)
	6430	24	3 W	SV7-8	T2.5			10	C				Standard (8x29mm)
	6438	12	10 W	SV7-8	T2.5			10	C				Standard (8x31mm)
PARKING LIGHT, LICENSE PLATE LIGHT, GLOVE COMPARTMENT LIGHT, INTERIOR LIGHT, TRUNK LIGHT													
SV8.5-8  	DE3175	12	10 W	SV8.5-8	T3.25			10	C	■			Standard (10x31mm)
	◆ DE3175TB	12	10 W	SV8.5-8	T3.25			2	B	■			Standard (10x31mm)
	◆ DE3175SB	12	10 W	SV8.5-8	T3.25			1	B				Standard (10x31mm)
	DE3425	12	10 W	SV8.5-8	T3.25			10	C	■			Standard (13x37mm)
	6411	12	10 W	SV8.5-8	T3.25			10	C				Standard (10x41mm)
	◆ 6411TB	12	10 W	SV8.5-8	T3.25			2	B				Standard (10x41mm)
	◆ 6411LED 6.5K	12	1 W	SV8.5-8	T3.25			1	B				LED
	◆ 6411LED 5K	12	1 W	SV8.5-8	T3.25			1	B				LED
	6418	12	5 W	SV8.5-8	T3.25			10	C		■	■	Standard (10x35mm)
	◆ 6418TB	12	5 W	SV8.5-8	T3.25			2	B		■	■	Standard (10x35mm)
	◆ 6418LED 6.5K	12	1 W	SV8.5-8	T3.25			1	B				LED
	◆ 6418LED 5K	12	1 W	SV8.5-8	T3.25			1	B				LED
	6423	24	5 W	SV8.5-8	T3.25			10	C		■	■	Standard (10x35mm)
	◆ 6423TB	24	5 W	SV8.5-8	T3.25			2	B		■	■	Standard (10x35mm)
	6429	24	10 W	SV8.5-8	T3.25			10	C				Standard (11x41mm)
	◆ 6429TB	24	10 W	SV8.5-8	T3.25			2	B				Standard (11x41mm)
PARKING LIGHT, LICENSE PLATE LIGHT, GLOVE COMPARTMENT LIGHT, INTERIOR LIGHT, TRUNK LIGHT													
SV8.5-8  	6451	12	15 W	SV8.5-8	T4.625			10	C				Standard (15x44mm)
	6453	24	15 W	SV8.5-8	T4.625			10	C				Standard (15x44mm)
	6475	12	18 W	SV8.5-8	T4.625			10	C				Standard (15x41mm)
	6476	12	21 W	SV8.5-8	T4.75			10	C		■		Standard (15x43mm)
	6480	24	18 W	SV8.5-8	T4.625			10	C				Standard (15x43mm)
PARKING LIGHT, LICENSE PLATE LIGHT, GLOVE COMPARTMENT LIGHT, INTERIOR LIGHT, TRUNK LIGHT													

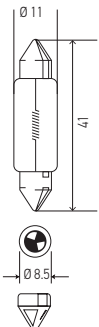
Measures in millimeters

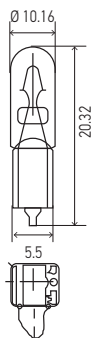

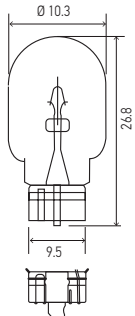
PRODUCT RANGE

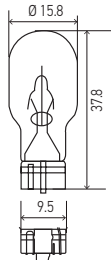
MINIATURE BULBS SUMMARY

Product Image / Dimensions	Part Number	Voltage	Wattage	Base	Shape	Luminous Flux (lumens)	Kelvin	Content	Packaging	DOT	ECE	INMETRO	Features	
SV8.5-8 C5W  	6413	12	5 W	SV8.5-8	T3.25			10	C				Standard (11x41mm)	
	6424	24	5 W	SV8.5-8	T3.25			10	C				Standard (11x41mm)	
PARKING LIGHT, LICENSE PLATE LIGHT, GLOVE COMPARTMENT LIGHT, INTERIOR LIGHT, TRUNK LIGHT														
W2.1x4.9d  	17	24	2 W	W2.1x4.9d	T1.75			10	C	■			Standard	
	73	12	1.1 W	W2.1x4.9d	T1.75			10	C	■			Standard	
	◆ 73TB	12	1.1 W	W2.1x4.9d	T1.75			2	B	■			Standard	
	74	12	1.4 W	W2.1x4.9d	T1.75			10	C	■		■	Standard	
DASHBOARD LIGHT														
W2.1x9.5d  	158	12	3 W	W2.1x9.5d	T3.25			10	C	■			Standard	
	158A	12	3 W	W2.1x9.5d	T3.25			10	C	■			Standard (Amber)	
	◆ 158TB	12	3 W	W2.1x9.5d	T3.25			2	B	■			Standard	
	168	12	5 W	W2.1x9.5d	T3.25			10	C	■			Standard	
	◆ 168TB	12	5 W	W2.1x9.5d	T3.25			2	B	■			Standard	
	194	12	4 W	W2.1x9.5d	T3.25			10	C	■			Standard	
	194B	12	4 W	W2.1x9.5d	T3.25			10	C	■			Standard (Blue)	
	194NA	12	4 W	W2.1x9.5d	T3.25			10	C	■			Standard (Nat. amber)	
	194R	12	4 W	W2.1x9.5d	T3.25			10	C	■			Standard (Red)	
	400	24	3 W	W2.1x9.5d	T3.25			10	C	■			Standard	
	◆ 2840	24	2 W	W2.1x9.5d	T3.25			10	C	■			Standard	
	DASHBOARD LIGHT													
	W2.1x9.5d  	912	12	13 W	W2.1x9.5d	T5			10	C	■			Standard
921		12	16 W	W2.1x9.5d	T5			10	C	■	■		Standard	
◆ 921NA		12	18 W	W2.1x9.5d	T5			10	C	■	■		Standard	
◆ 921TB		12	16 W	W2.1x9.5d	T5			2	B	■	■		Standard	
◆ 921SB		12	16 W	W2.1x9.5d	T5			1	B	■	■		Standard	
◆ 921LED 6.5K		12	1 W	W2.1x9.5d	T5			2	B				LED	
◆ 921LED 5K		12	1 W	W2.1x9.5d	T5			2	B				LED	
PARKING LIGHT														

C = Box B = Blister Pack P = Plastic Case
 * = OPTILUX Product Range ◆ = New Product

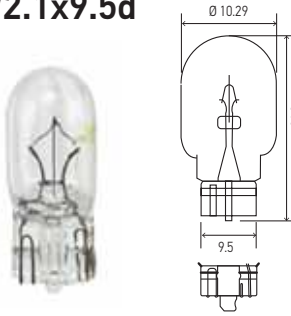

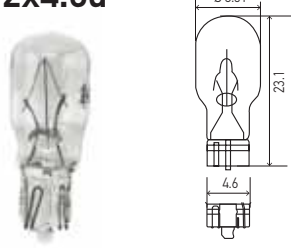
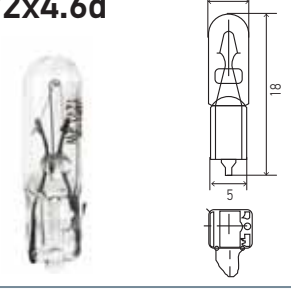
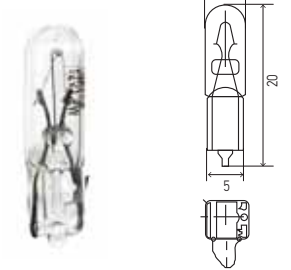





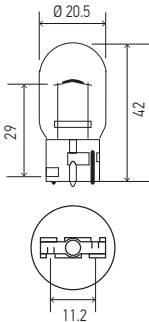

Measures in millimeters

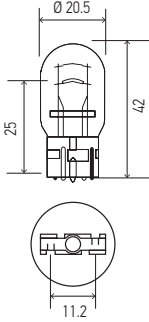
Product Image / Dimensions	Part Number	Voltage	Wattage	Base	Shape	Luminous Flux (lumens)	Kelvin	Content	Packaging	DOT	ECE	INMETRO	Features	
W2.1x9.5d 	2820	12	2 W	W2.1x9.5d	T3.25			10	C				Standard	
	2821	12	3 W	W2.1x9.5d	T3.25			10	C		■	■	Standard	
	◆ 2821TB	12	3 W	W2.1x9.5d	T3.25			2	B		■	■	Standard	
	◆ 2821SB	12	3 W	W2.1x9.5d	T3.25			1	B		■	■	Standard	
	2825	12	5 W	W2.1x9.5d	T3.25			10	C		■	■	Standard	
	2825BL	12	5 W	W2.1x9.5d	T3.25			10	C				Standard (Blue)	
	◆ 2825TB	12	5 W	W2.1x9.5d	T3.25			2	B				Standard	
	◆ 2825SB	12	5 W	W2.1x9.5d	T3.25			1	B		■		Standard	
	2827NA	12	5 W	W2.1x9.5d	T3.25			10	C		■	■	Standard (Nat. amber)	
	◆ 2827NATB	12	5 W	W2.1x9.5d	T3.25			2	B		■	■	Standard	
	2841	24	3 W	W2.1x9.5d	T3.25			10	C		■	■	Standard	
	◆ 2841TB	24	3 W	W2.1x9.5d	T3.25			2	B		■	■	Standard	
	2845	24	5 W	W2.1x9.5d	T3.25			10	C				Standard	
	◆ 2845SB	24	5 W	W2.1x9.5d	T3.25			1	B		■	■	Standard	
	◆ 2845TB	24	5 W	W2.1x9.5d	T3.25			2	B		■	■	Standard	
	3652	12	5 W	W2.1x9.5d	T3.25			10	C				Standard	
	PARKING LIGHT, DASHBOARD LIGHT, LICENSE PLATE LIGHT, GLOVE COMPARTMENT LIGHT, FLASHING LIGHT ADDITIONAL, INTERIOR LIGHT													
	W2.5x16d 	3156	12	27 W	W2.5x16d	S8			10	C	■	■		Standard
3047		12	21/7 W	W2.5x16q	S8			10	C	■			Standard	
3047LL		12	21/7 W	W2.5x16q	S8			10	C	■			Long Life	
3057		12	27/7 W	W2.5x16q	S8			10	C	■			Standard	
3157		12	27/7 W	W2.5x16q	S8			10	C	■			Standard	
3157LL		12	27/7 W	W2.5x16q	S8			10	C	■	■		Long Life	
◆ 3157TB		12	27/7 W	W2.5x16q	S8			2	B		■		Standard	
3157NA		12	27/7 W	W2.5x16q	S8			10	C	■			Standard (Nat. amber)	
3457		12	29/8 W	W2.5x16q	S8			10	C	■			Standard	
3457NA		12	29/8 W	W2.5x16q	S8			10	C	■			Standard (Nat. amber)	
FLASHING LIGHT, REAR SIGNAL LIGHT														
W2x4.6d 	24	12	3 W	W2x4.6d	T2.75			10	C	■			Standard	
	24NA	12	3 W	W2x4.6d	T2.75			10	C	■			Standard (Nat. amber)	
LOW BEAM, HIGH BEAM, FOG LIGHT (WHERE APPLICABLE)														
W2x4.6d 	37	12	1.3 W	W2x4.6d	T1.75			10	C	■			Standard	
LOW BEAM, HIGH BEAM, FOG LIGHT (WHERE APPLICABLE)														
W2x4.6d 	2721	12	1.2 W	W2x4.6d	T1.5			10	C	■		■	Standard	
	◆ 2721TB	12	1.2 W	W2x4.6d	T1.5			2	B		■		Standard	
	◆ 2722	12	2.1 W	W2x4.6d	T1.5			10	C			■	Standard	
	2723	12	2.3 W	W2x4.6d	T1.5			10	C		■		Standard	
	2741	24	1.2 W	W2x4.6d	T1.5			10	C				Standard	
	◆ 2741TB	24	1.2 W	W2x4.6d	T1.5			2	B				Standard	
DASHBOARD LIGHT														

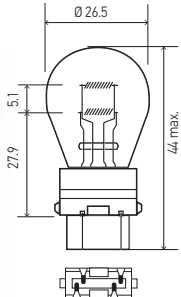
Measures in millimeters

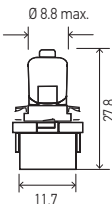

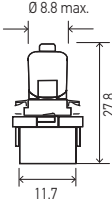

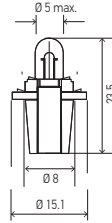





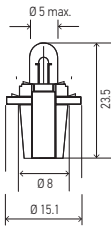

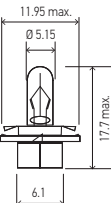
PRODUCT RANGE

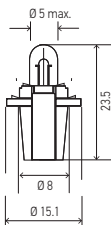
MINIATURE BULBS SUMMARY

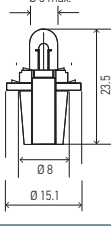
Product Image / Dimensions	Part Number	Voltage	Wattage	Base	Shape	Luminous Flux (lumens)	Kelvin	Content	Packaging	DOT	ECE	INMETRO	Features
 	7440	12	21 W	W3x16d	T6.5			10	C	■	■	■	Standard
	7440LL	12	21 W	W3x16d	T6.5			10	C	■	■	■	Long Life
	7440NA	12	21 W	W3x16d	T6.5			10	C	■	■		Standard (Nat. amber)
	7440TB	12	21 W	W3x16d	T6.5			2	B	■			Standard
	7441	12	27 W	W3x16d	T6.5			10	C	■			Standard
REAR POSITION LIGHT, STOP LIGHT													
 	7443	12	21/5 W	W3x16d	T6.5			10	C	■	■	■	Standard
	7443LL	12	21/5 W	W3x16d	T6.5			10	C	■	■	■	Long Life
	7443A	12	21/5 W	W3x16d	T6.5			10	C	■			Standard (Amber)
	7443NA	12	21/5 W	W3x16d	T6.5			10	C	■			Standard (Nat. amber)
	7443TB	12	21/5 W	W3x16d	T6.5			2	B	■	■	■	Standard
FLASHING LIGHT AND REAR SIGNAL LIGHT, ADDITIONAL FLASHING LIGHT, STOP LIGHT													
 	3757A	12	27/7 W	W2.5x16q	S8			10	C	■			Standard (Amber)
	FLASHING LIGHT AND REAR SIGNAL LIGHT, STOP LIGHT												
 	007997101	12	3 W	B10d				10	C				Brown base
	DASHBOARD LIGHT												
 	007997111	12	5 W	B10d				10	C				Black base
	DASHBOARD LIGHT												
 	007997061	24	1.2 W	B8.3d				10	C				Grey base
	DASHBOARD LIGHT												

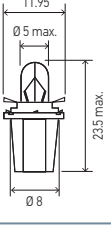
C = Box B = Blister Pack P = Plastic Case
 * = OPTILUX Product Range ◆ = New Product

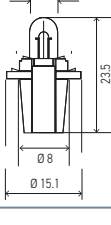

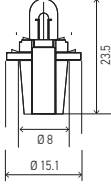







Measures in millimeters

Product Image / Dimensions	Part Number	Voltage	Wattage	Base	Shape	Luminous Flux (lumens)	Kelvin	Content	Packaging	DOT	ECE	INMETRO	Features
B8.3d  	007997001	12	2 W	B8.3d				10	C				White base
DASHBOARD LIGHT													
B8.5d  	007997031	12	1.2 W	B8.5d				10	C				Black base
DASHBOARD LIGHT													
B8.3d  	007997041	12	1.2 W	B8.3d				10	C				Black base
DASHBOARD LIGHT													
B8.5d  	007997071	24	1.2 W	B8.5d				10	C				Grey base
DASHBOARD LIGHT													
B8.5d  	007997081	12	2 W	B8.5d				10	C				Green base
DASHBOARD LIGHT													
B8.7d  	007997051	12	2 W	B8.7d				10	C				Grey base
DASHBOARD LIGHT													
B8.7d  	007997091	12	2 W	B8.7d				10	C				Green base
DASHBOARD LIGHT													

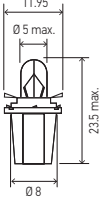
Measures in millimeters

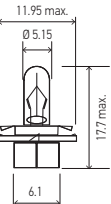

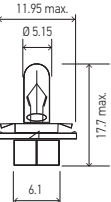

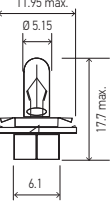



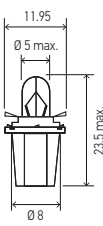

PRODUCT RANGE

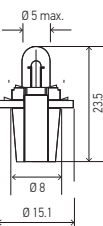
MINIATURE BULBS SUMMARY

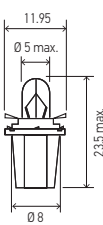
Product Image / Dimensions	Part Number	Voltage	Wattage	Base	Shape	Luminous Flux (lumens)	Kelvin	Content	Packaging	DOT	ECE	INMETRO	Features
BG8.5-5.5d 	007997231	12	1.2 W	BG8.5-5.5d				10	C				Black base
	DASHBOARD LIGHT												
BG8-5.5d 	007997241	12	1.2 W	BG8-5.5d				10	C				Black base
	DASHBOARD LIGHT												
BG8.5-S/40 	007997251	12	1.2 W	BG8.5-S/40				10	C				Black base
	DASHBOARD LIGHT												
BX8.4d  	007997121	12	1.2 W	BX8.4d				10	C				Black base
	DASHBOARD LIGHT												
BX8.4d  	007997131	12	1.5 W	BX8.4d				10	C				Green base
	DASHBOARD LIGHT												
BX8.4d  	007997141	12	1.5 W	BX8.4d				10	C				Beige base
	DASHBOARD LIGHT												
BX8.4d  	007997171	12	1.1 W	BX8.4d				10	C				Orange base
	DASHBOARD LIGHT												

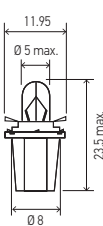
C = Box B = Blister Pack P = Plastic Case
 * = OPTILUX Product Range  = New Product

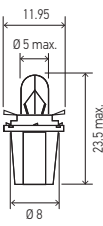

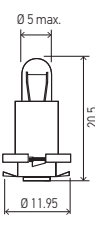

Measures in millimeters

Product Image / Dimensions	Part Number	Voltage	Wattage	Base	Shape	Luminous Flux (lumens)	Kelvin	Content	Packaging	DOT	ECE	INMETRO	Features
BX8.5d  	007997151	12	0.36 W	BX8.5d				10	C				Violet base
DASHBOARD LIGHT													
BX8.5d  	007997161	12	1.5 W	BX8.5d				10	C				Beige base
DASHBOARD LIGHT													
BX8.5d  	007997211	12	1.2 W	BX8.5d				10	C				Blue base
DASHBOARD LIGHT													
BX8.5d  	007997221	12	2 W	BX8.5d				10	C				Light Green base
DASHBOARD LIGHT													
BX8.5d  	007997261	24	1.2 W	BX8.5d				10	C				Brown base
DASHBOARD LIGHT													
EBS N10 	007997272	24	1.2 W	EBS N10				10	C				Grey base
DASHBOARD LIGHT													
EBS R4  	007997191	24	1.2 W	EBS R4				10	C				Yellow base
DASHBOARD LIGHT													

Measures in millimeters

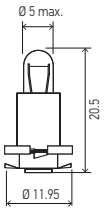
PRODUCT RANGE

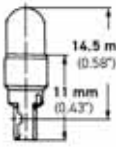
MINIATURE BULBS SUMMARY

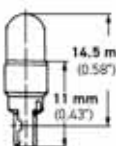
Product Image / Dimensions	Part Number	Voltage	Wattage	Base	Shape	Luminous Flux (lumens)	Kelvin	Content	Packaging	DOT	ECE	INMETRO	Features
EBS R6  	007997201	24	1.2 W	EBS R6				10	C				Brown base
	DASHBOARD LIGHT												
W2x4.6d  	007997011	12	1.2 W	W2x4.6d		T1.5		10	C				White base
	DASHBOARD LIGHT												
W2x4.6d  	007997021	24	1 W	W2x4.6d		T1.5		10	C				White base
	DASHBOARD LIGHT												

PRODUCT RANGE

3.3 BULBS AND FUSES SET

Product Image / Dimensions	Part Number	Set Content	Voltage	Wattage	Base	Shape	Luminous Flux (lumens)	Kelvin	Content	Packaging	DOT	ECE	INMETRO	
	◇ H1EMK	H1	12	55 W	P14.5s	T2.5	1550		1	P	■	■	■	
		1034	12	23/8 W	BAY15d	S8			1	P	■			
		7507 (P21W)	12	21 W	BAU15s	S8				1	P		■	■
		2825 (W5W)	12	5 W	W2.1x9.5d	T3.25				1	P		■	■
		Fuse: 10 A	12							1	P			
		Fuse: 20 A	12							1	P			
		Fuse: 30 A	12							1	P			
	◇ H4EMK	H4	12	60/55 W	P43t	T4.625		1650/1000	3200	1	P		■	■
		7528 (P21/5W)	12	21/5 W	BAY15d	S8				1	P		■	■
		7506 (P21W)	12	21 W	BA15s	S8				1	P		■	■
		5007 (W5W)	12	5 W	BA15s	B6				1	P		■	■
		7507 (P21W)	12	21 W	BAU15s	S8				1	P		■	■
		3893 (T4W)	12	4 W	BA9s	T2.75				1	P	■	■	
		Fuse: 10 A	12							1	P			
Fuse: 20 A		12							1	P				
Fuse: 30 A		12							1	P				
◇ H7EMK		H7	12	55 W	PX26d	T4.625		1350		1	P	■	■	■
	7528 (P21/5W)	12	21/5 W	BAY15d	S8				1	P		■	■	
	7506 (P21W)	12	21 W	BA15s	S8				1	P		■	■	
	5007 (W5W)	12	5 W	BA15s	B6				1	P		■	■	
	7507 (P21W)	12	21 W	BAU15s	S8				1	P		■	■	
	2825 (W5W)	12	5 W	W2.1x9.5d	T3.25				1	P		■	■	
	Fuse: 10 A	12							1	P				
	Fuse: 20 A	12							1	P				
Fuse: 30 A	12							1	P					
◇ 9005EMK	9005	12	65 W	P20d	T4		1860		1	P	■	■	■	
	1157A (P21/5W)	12	27/8 W	BAY15d	S8				1	P	■			
	3757A	12	27/7 W	WX2.5X16q	S8				1	P	■			
	2825 (W5W)	12	5 W	W2.1x9.5d	T3.25				1	P		■	■	
	Fuse: 10 A	12							1	P				
	Fuse: 20 A	12							1	P				
Fuse: 30 A	12							1	P					
◇ 9006EMK	9006	12	55 W	P22d	T4		1095		1	P	■	■	■	
	1157A (P21/5W)	12	27/8 W	BAY15d	S8				1	P	■			
	3757A	12	27/7 W	WX2.5X16q	S8				1	P	■			
	2825 (W5W)	12	5 W	W2.1x9.5d	T3.25				1	P		■	■	
	Fuse: 10 A	12							1	P				
	Fuse: 20 A	12							1	P				
Fuse: 30 A	12							1	P					
◇ H724VEMK	H7 24V	24	70 W	PX26d	T4.625		1750		1	P		■	■	
	7537 (P21/5W)	24	21/5 W	BAY15d	S8				1	P				
	7511 (P21W)	24	21 W	BA15s	S8				1	P		■	■	
	5627	24	5 W	BA15s	B6				1	P		■	■	
	7510LTS (P21W)	24	21 W	BAU15s	S8				1	P				
	Fuse: 10 A	24							1	P				
	Fuse: 20 A	24							1	P				
	Fuse: 30 A	24							1	P				
◇ H424VEMK	H4 24V	24	75/70 W	P43t	T4.625		1900/1200		1	P		■	■	
	7537 (P21/5W)	24	21/5 W	BAY15d	S8				1	P				
	7511 (P21W)	24	21 W	BA15s	S8				1	P		■	■	
	5627	24	5 W	BA15s	B6				1	P		■	■	
	7510LTS (P21W)	24	21 W	BAU15s	S8				1	P				
	Fuse: 10 A	24							1	P				
	Fuse: 20 A	24							1	P				
Fuse: 30 A	24							1	P					



NEW!







Modern light inside the car in a simple way with the new HELLA LED bulbs. The new HELLA LED Bulbs features a pleasant color temperature, with a high performance light and especially for energy efficiency and long life.

3.4 LED MINIATURE BULBS

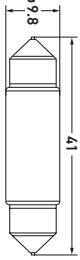
PRODUCT RANGE

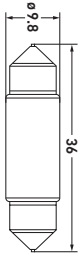
LED MINIATURE BULBS

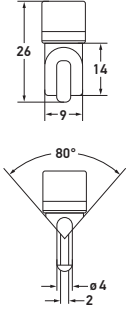
Product Image / Dimensions	Part Number	Voltage	Wattage	Base	Shape	Luminous Flux (lumens)	Kelvin	Content	Packaging	DOT	ECE	INMETRO	Features
6411 LED  	◆ 6411LED 5K	12	1 W	SV8.5-8	-	-	5000	1	B				
	◆ 6411LED 6.5K	12	1 W	SV8.5-8	-	-	6500	1	B				
REPLACES: 6411, 6413, 6451, 6475													
6418 LED  	◆ 6418LED 5K	12	1 W	SV8.5-8	-	-	5000	1	B				
	◆ 6418LED 6.5K	12	1 W	SV8.5-8	-	-	6500	1	B				
REPLACES: 6418													
921 LED  	◆ 921LED 5K	12	1 W	W2.1x9.5d	-	-	5000	2	B				
	◆ 921LED 6.5K	12	1 W	W2.1x9.5d	-	-	6500	2	B				
REPLACES: 921, 158, 168, 194, 2820, 2821, 2825, 2827, 3652, 912													



**NEW
4300 K & 5000K**

Mercury Free



With a color temperature of 4300K, twice as bright as halogen bulbs and with about three times their luminous efficiency, the white light of these new generation xenon bulbs ensures safety and relaxed driving.

The new HELLA XENON +30 bulbs have a color temperature of up to 5000K, which rivals white LED daytime running lights, offer maximum illumination and visibility similar to daylight. With a low power consumption of 35W, resistance to vibrations and a long service life.

3.5 High Intensity Discharge Lamps (HID)

PRODUCT RANGE

HIGH INTENSITY DISCHARGE LAMPS (HID)

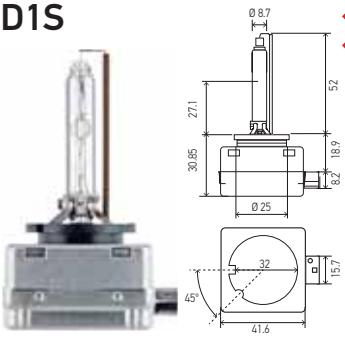
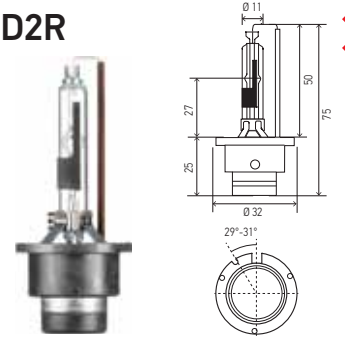
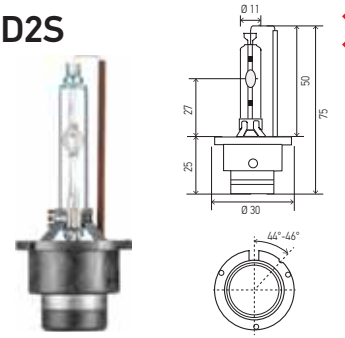
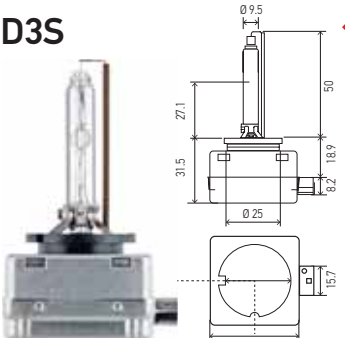
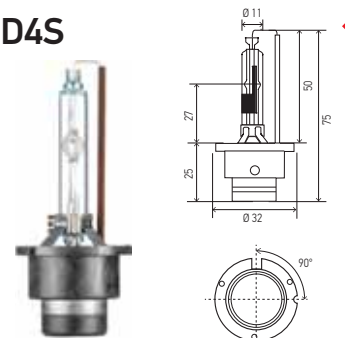
Product Image / Dimensions	Part Number	Voltage	Wattage	Base	Shape	Luminous Flux (lumens)	Kelvin	Content	Packaging	DOT	ECE	INMETRO	Features
	◆ D1S 4300 K	12/24	35 W	PK32d-2	T3	3,200	4300	1	C	■			Standard
	◆ D1S 5000 K	12/24	35 W	PK32d-2	T3		5000	1	C	■			Performance +30
LOW BEAM, HIGH BEAM													
	◆ D2R 4300 K	12/24	35 W	P32d-3	T3	3,200	4300	1	C		■		Standard
	◆ D2R 5000 K	12/24	35 W	P32d-3	T3	2,800	5000	1	C	■	■		Performance +30
LOW BEAM, HIGH BEAM													
	◆ D2S 4300 K	12/24	35 W	P32d-2	T2-3/4	3,200	4300	1	C				Standard
	◆ D2S 5000 K	12/24	35 W	P32d-2	T2-3/4		5000	1	C				Performance +30
LOW BEAM, HIGH BEAM													
	◆ D3S 4300 K	12/24	35 W	P32d-2	T3	3,200	4300	1	C		■		Standard
LOW BEAM, HIGH BEAM													
	◆ D4S 4300 K	12/24	35 W	P32d-5	T2-3/4	2,800	4300	1	C				Standard
LOW BEAM, HIGH BEAM													

C = Box B = Blister Pack P = Plastic Case
 * = OPTILUX Product Range ◆ = New Product

Measures in millimeters

HELLA BULBS

BLISTER PACKS



HELLA develops and manufactures light bulbs for the automotive industry and also has one of the largest retail organizations for auto parts. Our new range of blister packs lets you choose between different styles of light bulbs in a striking design for retail.

NEW!



STANDARD

STANDARD

- 12 V and 24 V, double and individual blister
- Exclusive high-quality quartz crystal halogen gas formulation
- Original equipment quality
- Excellent luminous efficiency, quality / price
- Complies with global standards (ECE R37, SAE / DOT and INMETRO regulations)



PERFORMANCE

HELLA +50

- 12 V, double blister pack
- Up to 50% more light than standard HELLA bulbs
- Exclusive high-quality quartz crystal halogen gas formulation
- Meets global standards (ECE R37, SAE / DOT and INMETRO regulations).



PERFORMANCE

HIGH PERFORMANCE 2.0

- 12 V, double blister pack
- Up to 100% more light than standard HELLA bulbs
- Exclusive halogen gas and high quality quartz crystal formulation with blue coating
- Meets global standards (ECE R37, SAE / DOT and INMETRO regulations).



DESIGN

XTREME YELLOW

- Improved visibility under foggy, hail and rain conditions, due to its color temperature reduces reflection on objects
- 12 V - Double blister pack
- Exclusive high-quality halogen gas and quartz crystal formulation with yellow coating
- Recommended for vehicles in rural and off-road areas
- For off-road use.



HIGH WATTAGE

HIGH WATTAGE

- 12 V - double and single blister pack
- More light output compared to standard HELLA bulbs
- Excellent luminous efficiency, quality / price ratio
- For off-road use only



HEAVY DUTY

HEAVY DUTY / DOUBLE POWER

- 12 V and 24 V- Box, double and single blister pack
- Greater durability and resistance to vibrations compared to standard HELLA bulbs
- Heavy-duty bulbs offer more power and durability by reducing replacement times.



PRODUCT RANGE

SPECIAL BULBS



HELLA STANDARD - HALOGEN

HELLA Standard halogen lamps provide original equipment manufacturer quality and a great value for your money. DOT, ECE and inmetro certified*

Note: Please note that bulbs with too high of a wattage can cause the overheating of the wiring and damage to the headlight.

Features:

- Best mixture of light output and reliability
- Original equipment quality
- Excellent luminous efficiency.
- Excellent quality / price

HELLA STANDARD - HALOGEN 12 V

Double Blister Pack



Part Number	Type	Voltage	Wattage	Base	Content	Packaging
◆ 9003TB	9003/HB2	12 V	60/55 W	P43t	2	B
◆ 9004TB	9004/HB1	12 V	65/45 W	P29t	2	B
◆ 9005TB	9005/HB3	12 V	65 W	P20d	2	B
◆ 9006TB	9006/HB4	12 V	55 W	P22d	2	B
◆ 9007TB	9007/HB5	12 V	65/55 W	PX29t	2	B
◆ H1TB	H1	12 V	55 W	P14.5s	2	B
◆ H10TB	H10	12 V	45 W	PY20d	2	B
◆ H11TB	H11	12 V	55 W	PGJ19-2	2	B
◆ H13TB	H13	12 V	60/55 W	P26.4t	2	B
◆ H3TB	H3	12 V	55 W	PK22s	2	B
◆ H3 35WTB	H3	12 V	35 W	PK22s	2	B
◆ H4TB	H4	12 V	60/55 W	P43t	2	B
◆ H4 35/35WTB	H4	12 V	35/35 W	P43t	2	B
◆ H4 45/45WTB	H4	12 V	45/45 W	P43t	2	B
◆ H4 P45TTB	H4	12 V	60/55 W	P45t	2	B
◆ H7TB	H7	12 V	55 W	PX26d	2	B
◆ H8TB	H8	12 V	35 W	PGJ19-1	2	B
◆ H9TB	H9	12 V	65 W	PGJ19-5	2	B
◆ HS1TB	HS1	12 V	35/35 W	PX43t	2	B
◆ M5 35/35WTB	M5	12 V	35/35 W	P15d-25-1	2	B

Single Blister Pack



Part Number	Type	Voltage	Wattage	Base	Content	Packaging
◆ 9003SB	9003/HB2	12 V	60/55 W	P43t	1	B1
◆ 9004SB	9004/HB1	12 V	65/45 W	P29T	1	B1
◆ 9005SB	9005/HB3	12 V	65 W	P20d	1	B1
◆ 9006SB	9006/HB4	12 V	55 W	P22d	1	B1
◆ 9007SB	9007/HB5	12 V	65/55 W	PX29t	1	B1
◆ H1SB	H1	12 V	55 W	P14.5s	1	B1
◆ H10SB	H10/9145	12 V	45 W	PY20d	1	B1
◆ H11SB	H11	12 V	55 W	PGJ19-2	1	B1
◆ H13SB	H13	12 V	60/55 W	P26.4t	1	B1
◆ H3SB	H3	12 V	55 W	PK22s	1	B1
◆ H3 35WSB	H3	12 V	35 W	PK22s	1	B1
◆ H4SB	H4	12 V	60/55 W	P43T	1	B1
◆ H4 35/35WSB	H4	12 V	35/35 W	P43T	1	B1
◆ H4 45/45WSB	H4	12 V	45/45 W	P43T	1	B1
◆ H4 P45TSB	H4	12 V	60/55 W	P45t	1	B1
◆ H7SB	H7	12 V	55 W	PX26d	1	B1
◆ H8SB	H8	12 V	35 W	PGJ19-1	1	B1
◆ H9SB	H9	12 V	65 W	PGJ19-5	1	B1
◆ HS1SB	HS1	12 V	35/35 W	PX43t	1	B1
◆ M5 35/35WSB	M5	12 V	35/35 W	P15d-25-1	1	B1
◆ H16SB	H16	12 V	19 W	PGJ19-3	1	B1



HELLA STANDARD - MINIATURE BULBS

Miniature bulbs cover a wide range of mostly low voltage bulb types with unique shapes and bases. HELLA miniature bulbs are manufactured with precise lighting requirements to fit a wide variety of brake lamp, stop lamp, turn signal, and reverse lamp applications. DOT, ECE and inmetro certified*

Features:

- Fits a wide variety of applications
- Excellent luminous efficiency.
- Excellent quality / price



HELLA STANDARD MINIATURE:

Double Blister Pack.



Single Blister Pack.



Part Number	Type	Voltage	Wattage	Base	Content	Packaging
◆ 7506TB	7506	12 V	21 W	BA15s	2	B
◆ 1034TB	1034	12 V	23/8 W	BAY15D	2	B
◆ 2825TB	2825	12 V	5 W	W2.1x9.5d	2	B
◆ 7528TB	7528	12 V	21/5 W	BAY15d	2	B
◆ 921TB	921	12 V	16 W	W2.1x9.5d	2	B
◆ 7443TB	7443	12 V	21/5 W	W3X16q	2	B
◆ 158TB	158	12 V	3 W	W2.1x9.5d	2	B
◆ 5007TB	5007	12 V	5 W	BA15s	2	B
◆ 67TB	67	12 V	8 W	BA15s	2	B
◆ 3898TB	3898	12 V	2 W	BA7s	2	B
◆ 3157TB	3157	12 V	27/7 W	W2.5x16q	2	B
◆ 5008TB	5008	12 V	10 W	BA15s	2	B
◆ 5637TB	5637	24 V	10 W	BA15s	2	B
◆ 3893TB	3893	12 V	4 W	BA9s	2	B
◆ 7440TB	7440	12 V	21 W	W3X16d	2	B
◆ 7507TB	7507	12 V	21 W	BAU15s	2	B
◆ DE3175TB	3175	12 V	10 W	SV8.5-8	2	B
◆ 6411TB	6411	12 V	10 W	SV8.5-8	2	B
◆ 2721TB	2721	12 V	1.2 W	W2x4.6d	2	B
◆ 168TB	168	12 V	5 W	W2.1x9.5d	2	B

Part Number	Type	Voltage	Wattage	Base	Content	Packaging
◆ 73TB	73	12 V	1.1 W	W2.1x4.9d	2	B
◆ 53TB	53	12 V	2 W	BA9s	2	B
◆ 1157TB	1157	12 V	27/8 W	BA9s	2	B
◆ 7507CTB	7507C	12 V	21 W	BAU15S	2	B
◆ 1141TB	1141	12 V	18 W	BA15s	2	B
◆ 7506ATB	7506A	12 V	21 W	BA15s	2	B
◆ 6418TB	6418	12 V	5 W	SV8.5-8	2	B
◆ DE3021TB	3021	12 V	3 W	SV7-8	2	B
◆ 7225TB	7225	12 V	21/4 W	BAZ15d	2	B
◆ 2827NATB	2827NA	12 V	5 W	W2.1x9.5d	2	B
◆ 2821TB	2821	12 V	3 W	W2.1x9.5d	2	B
◆ 2825SB	2825	12 V	5 W	W2.1x9.5d	1	B1
◆ 7528SB	7528	12 V	21/5 W	BAY15d	1	B1
◆ 921SB	921	12 V	16 W	W2.1x9.5d	1	B1
◆ 5007SB	5007	12 V	5 W	BA15s	1	B1
◆ 5008SB	5008	12 V	10 W	BA15s	1	B1
◆ 3893SB	3893	12 V	4 W	BA9s	1	B1
◆ DE3175SB	3175	12 V	10 W	SV8.5-8	1	B1
◆ 6235SB	6235	12 V	35/35 W	BA20d	1	B1
◆ DE3021SB	3021	12 V	35/35 W	SV7-8	1	B1
◆ 2821SB	2821	12 V	3 W	W2.1x9.5d	1	B1

PRODUCT RANGE

SPECIAL BULBS



HELLA STANDARD - 24 V

In a convenient presentation, HELLA presents its range of 24 V products in plastic blister packs with the same Original Equipment quality in both halogen bulbs and miniature bulbs.

Features:

- Double blister pack and single blister
- Original equipment quality
- Excellent luminous efficiency. Excellent quality / price
- Meets global standards (ECE R37, SAE / DOT and INMETRO)

HELLA STANDARD 24 V:

Double Blister Pack.



Part Number	Type	Voltage	Wattage	Base	Content	Packaging
◆ 1141 24VTB	1141	24 V	18 W	BA15s	2	B
◆ 2741TB	2741	24 V	1.2 W	W2x4.6d	2	B
◆ 2841TB	2841	24 V	3 W	W2.1x9.5d	2	B
◆ 2845TB	2845	24 V	5 W	W2.1x9.5d	2	B
◆ 3797TB	3797	24 V	2 W	BA9s	2	B
◆ 3930TB	3930	24 V	4 W	BA9s	2	B
◆ 5627TB	5627	24 V	5 W	BA15s	2	B
◆ 6423TB	6423	24 V	5 W	SV8.5-8	2	B
◆ 6429TB	6429	24 V	10 W	SV8.5-8	2	B
◆ 7510LTSTB	7510LTS	24 V	21 W	BAU15s	2	B
◆ 7511TB	7511	24 V	21 W	BA15s	2	B
◆ 7534TB	7534	24 V	21/5 W	BA15d	2	B
◆ 7537TB	7537	24 V	21/5 W	BAY15d	2	B
◆ 7952TB	7952	24 V	55/50 W	P45t	2	B
◆ 9507TB	9507	24 V	21 W	BAU15s	2	B
◆ H1 24VTB	H1	24 V	70 W	P14.5s	2	B
◆ H11 24VTB	H11	24 V	70 W	PGJ19-2	2	B
◆ H3 24VTB	H3	24 V	70 W	PK22s	2	B
◆ H4 24VTB	H4	24 V	75/70 W	P43t	2	B
◆ H7 24VTB	H7	24 V	70 W	PX26d	2	B
◆ H9 24VTB	H9	24 V	80 W	PGJ19-5	2	B

Single Blister Pack.



Part Number	Type	Voltage	Wattage	Base	Content	Packaging
◆ 1141 24VSB	1141	24 V	18 W	BA15s	1	B1
◆ 2845SB	2845	24 V	5 W	W2.1x9.5d	1	B1
◆ 5627SB	5627	24 V	5 W	BA15s	1	B1
◆ 7511SB	7511	24 V	21 W	BA15s	1	B1
◆ 7537SB	7537	24 V	21/5 W	BAY15d	1	B1
◆ H1 24VSB	H1	24 V	70 W	P14.5s	1	B1
◆ H11 24VSB	H11	24 V	70 W	PGJ19-2	1	B1
◆ H3 24VSB	H3	24 V	70 W	PK22s	1	B1
◆ H4 24VSB	H4	24 V	75/70 W	P43t	1	B1
◆ H7 24VSB	H7	24 V	70 W	PX26d	1	B1
◆ H9 24VSB	H9	24 V	80 W	PGJ19-5	1	B1



LONG LIFE



The special design of Long Life bulbs for passenger cars guarantees a longer service life, more light performance and reduced energy consumption, making them ideal for frequent drivers and permanent use of daytime running lights. Long Life represents bright but glare-free light. Good performance under extreme conditions for construction machinery or off-road vehicles.

Long Life combines unusual sturdiness and vibration resistance with convincing brightness and long service life.

Features:

- Up to 200% longer life time than HELLA standard bulbs.
- Special mixture of halogen gases to achieve high durability and increase life time
- Meets global standard (ECE R37 & SAE/DOT regulation).
- Color temperature 3,200 K

Some examples of the product range:



H4 24LL



H13LL

HELLA LONG LIFE:

Part Number	Type	Voltage	Wattage	Base	Shape	Luminous Flux (lumens)	Content	Packaging	DOT	ECE	INMETRO
H1LL	H1	12 V	55 W	P14.5s	T2.5	1550	1	C	■	■	■
◆ H4 24V LL	H4	24 V	75/70 W	P43t	T4.625	1900/1200	1	C	■	■	■
◆ H7 24V LL	H7	24 V	70 W	PX26d	T4.625	1750	1	C	■	■	■
◆ H7LL	H7	12 V	55 W	PX26d	T4.625	1500	1	C	■	■	■
H11LL	H11	12 V	55 W	PGJ19-2	T4	1350	1	C	■	■	
9003LL	9003	12 V	60/55 W	P43t	T4.625	1500/910	1	C	■		
9004LL	9004	12 V	65/45 W	P29t	T4.625	1200/700	1	C	■		■
9005LL	9005	12 V	65 W	P20d	T4	1860	1	C	■	■	■
◆ 9006LL	9006	12 V	55 W	P22d	T4	1095	1	C	■	■	■
9007LL	9007	12 V	65/55 W	PX29t	T4.625	1350/1000	1	C	■		
1003LL	1003	12 V	12 W	BA15s	B6		1	C	■		
1141LL	1141	12 V	18 W	BA15s	S8		1	C	■		
1156LL	1156	12 V	27 W	BA15s	S8		1	C	■		
1157LL	1157	12 V	27/8 W	BAY15d	S8		1	C	■		
2057LL	2057	12 V	27/7 W	BAY15d	S8		1	C	■		
2057NALL	2057	12 V	27/7 W	BAY15d	S8		1	C	■		
2357LL	2357	12 V	29/8 W	BAY15d	S8		1	C	■		
3047LL	3047	12 V	21/7 W	W2.5X16q	S8		1	C	■		
3157LL	3157	12 V	27/7 W	W2.5x16q	S8		1	C	■	■	
7440LL	7440	12 V	21 W	W3X16d	T6.5		1	C	■	■	■
7443LL	7443	12 V	21/5 W	W3X16q	T6.5		1	C	■	■	■

PRODUCT RANGE

SPECIAL BULBS



HIGH PERFORMANCE 2.0

HELLA's HP 2.0 Bulbs have been re-engineered to produce a brighter, whiter light which allows the driver to see more contrast in objects on the road, increasing safety and reaction time. These DOT compliant bulbs have been manufactured under strict HELLA guidelines and are an optimal balance of bulb performance and bulb life. The new HP 2.0 kits contain everything you need to get the job done.

Features:

- 12 V - Double Blister Pack
- Up to 100% more light than HELLA standard bulbs
- Meets global standard (ECE R37 & SAE/DOT and INMETRO regulation).
- Specially designed by halogen mixing gas & filament.
- Color temperature: 3,600 K

HELLA HIGH PERFORMANCE 2.0:

Part Number	Type	Voltage	Wattage	Base	Content	Packaging	DOT	ECE	INMETRO
◆ H1 2.0TB	H1	12 V	55 W	P14.5s	2	B	■	■	007691/2013
◆ H3 2.0TB	H3	12 V	55 W	PK22s	2	B	■	■	007696/2013
◆ 9003 2.0TB	H4 HB2 9003	12 V	60/55 W	P43t	2	B	■	■	007697/2013
◆ H7 2.0TB	H7 12V	12 V	55 W	PX26d	2	B	■	■	007698/2013
◆ H9 2.0TB	H9 12V	12 V	65 W	PGJ19-5	2	B	■	■	-
◆ H11 2.0TB	H11 12V	12 V	55 W	PGJ19-2	2	B	■	■	-
◆ H13 2.0TB	H13 9008	12 V	60/55 W	P26.4t	2	B	■	■	-
◆ 9004 2.0TB	9004 HB1	12 V	65/45W	P29t	2	B	■	■	007699/2013
◆ 9005 2.0TB	9005 HB3	12 V	65 W	P20d	2	B	■	■	007700/2013
◆ 9006 2.0TB	9006 HB4	12 V	55 W	P22d	2	B	■	■	007701/2013
◆ 9007 2.0TB	9007 HB5	12 V	65/55W	PX29t	2	B	■	■	-



HELLA Standar halogen bulb



HELLA High Performance 2.0



Re-engineered filament for greater light output

High quality quartz glass with a specialized blue coating

Exclusive halogen gas formulation for improved performance



HELLA +50

The HELLA +50 version produces 50 percent more light (compared to standard bulbs*) and extends the light cone, giving performance-oriented drivers additional safety time in case of an emergency situation.

Features:

- Up to 50% more light output than HELLA standard bulbs
- Meets global standard (ECE R37 & SAE/ DOT and INMETRO regulation).
- Filament design optimized
- Wider and brighter light
- OE quality
- With silver top coating to be invisible in the headlight

Some examples of the product range:

HELLA +50:

Part Number	Type	Voltage	Wattage	Base	Shape	Luminous Flux (lumens)	Content	Packaging	DOT	ECE	INMETRO
H1P50	H1	12 V	55 W	P14.5s	T2.5	1700	1	C	■	■	■
◆ H1P50TB	H1	12 V	55 W	P14.5s	T2.5	1700	2	B	■	■	■
H3P50	H3	12 V	55 W	PK22s	T3.25	1600	1	C	■	■	■
◆ H3P50TB	H3	12 V	55 W	PK22s	T3.25	1600	2	B	■	■	■
H4P50	H4	12 V	60/55 W	P43t	T4.625	1815/1100	1	C		■	■
◆ H4P50TB	H4	12 V	60/55 W	P43t	T4.625	1815/1100	2	B		■	■
H7P50	H7	12 V	55 W	PX26d	T4.625	1560	1	C	■	■	■
◆ H7P50TB	H7	12 V	55 W	PX26d	T4.625	1560	2	B	■	■	■
H11P50	H11	12 V	55 W	PGJ19-2	T4	1450	1	C	■	■	
◆ H11P50TB	H11	12 V	55 W	PGJ19-2	T4	1450	2	B	■	■	
H13P50	H13	12 V	60/55 W	P26.4t	T4	1650/1100	1	C	■	■	
◆ H13P50TB	H13	12 V	60/55 W	P26.4t	T4	1650/1100	2	B	■	■	
9004P50	9004	12 V	65/45 W	P29t	T4.625	1250/765	1	C	■		■
◆ 9004P50TB	9004	12 V	65/45 W	P29t	T4.625	1250/765	2	B	■		■
9005P50	9005	12 V	65 W	P20d	T4	2000	1	C	■	■	■
◆ 9005P50TB	9005	12 V	65 W	P20d	T4	2000	2	B	■	■	■
9006P50	9006	12 V	55 W	P22d	T4	1200	1	C	■	■	■
◆ 9006P50TB	9006	12 V	55 W	P22d	T4	1200	2	B	■	■	■
9007P50	9007	12 V	65/55 W	PX29t	T4.625	1450	1	C	■		
◆ 9007P50TB	9007	12 V	65/55 W	PX29t	T4.625	1450	2	B	■		



H4P50



H13P50

C = Box B = Blister Pack B1 = Single Blister Pack P = Plastic Case ◆ = New Product

PRODUCT RANGE

SPECIAL BULBS



HIGH WATTAGE

The ideal bulbs for professionals who travel off-road, or have a special demand for high power. Such as those in agriculture or forestry, or on building sites. In addition, HELLA bulbs have been involved in many victories in 24-hour races.

Note: Please note that bulbs with too high of a wattage can cause the overheating of the wiring and damage to the headlight.

Features:

- Box, double and single blister pack
- Longer service life compared to standard HELLA bulbs
- Environmentally friendly, because they do not have to be replaced as often.
- Excellent luminous efficiency.
- Excellent quality / price
- For off-road use only

Some examples of the product range:

HELLA HIGH WATTAGE:

Part Number	Type	Voltage	Wattage	Base	Shape	Luminous Flux (lumens)	Content	Packaging	DOT	ECE	INMETRO
H1 100W	H1	12 V	100 W	P14.5s	T2.5	1850	1	C			
◆ H1 100WTB	H1	12 V	100 W	P14.5s	T2.5	1850	2	B			
H1 130W	H1	12 V	130 W	P14.5s	T2.5	2400	1	C			
H2 100W	H2	12 V	100 W	X511	T3		1	C			
H3 100W	H3	12 V	100 W	PK22s	T3.25	1850	1	C			
◆ H3 100WTB	H3	12 V	100 W	PK22s	T3.25	1850	2	B			
H3 130W	H3	12 V	130 W	PK22s	T3.25	2600	1	C			
◆ H3 130WTB	H3	12 V	130 W	PK22s	T3.25	2600	2	B			
H3 24V 100W	H3	24 V	100 W	PK22s	T3.25	2500	1	C			
H4 100/55W	H4	12 V	100/55 W	P43t	T4.625	2400/1000	1	C			
◆ H4 100/55WTB	H4	12 V	100/55 W	P43t	T4.625	2400/1000	2	B			
H4 100/80W	H4	12 V	100/80 W	P43t	T4.625		1	C			
◆ H4 100/80WTB	H4	12 V	100/80 W	P43t	T4.625		2	B			
H4 130/90W	H4	12 V	130/90 W	P43t	T4.625	3200/1600	1	C			
◆ H4 130/90WTB	H4	12 V	130/90 W	P43t	T4.625	3200/1600	2	B			
H4 24V 100/90W	H4	24 V	100/90 W	P43t	T4.625		1	C			
H7 100W	H7	12 V	100 W	PX26d	T4.625	2000	1	C			
◆ H7 100WTB	H7	12 V	100 W	PX26d	T4.625	2000	2	B			
H7 70W	H7	12 V	70 W	PX26d	T4.625	1800	1	C			
9004 100/80W	9004	12 V	100/80 W	P29t	T4.625	1600/1300	1	C			
9005 100W	9005	12 V	100 W	P20d	T4	2200	1	C			
9006 80W	9006	12 V	80 W	P22d	T4	1650	1	C			
9007 100/80W	9007	12 V	100/80 W	PX29t	T4.625	1800/1500	1	C			
◆ H4 100/80WSB	H4	12 V	100/80 W	P43t	T4.625		1	B1			
◆ 9007 100/80WSB	9007	12 V	100/80 W	PX29t	T4.625	1800/1500	1	B1			
◆ 9004 100/80WSB	9004	12 V	100/80 W	P29t	T4.625	1600/1300	1	B1			
◆ 9006 80WSB	9006	12 V	80 W	P22d	T4	1650	1	B1			
◆ 9005 100WSB	9005	12 V	100 W	P20d	T4	2200	1	B1			



9005 100W



9004 100/80W



HEAVY DUTY | DOUBLE POWER

Durability, resistance to vibration with 24V power produces excellent light in a single filament. Heavy Duty bulbs offer more power, more safety, without dazzling vehicles. Thanks to its power and increased lifespan, the replacement costs are reduced drastically.

Features:

- Increased vibration resistance
- All advantages of standard bulbs
- Reduced downtime cost due to less bulb changes

Some examples of the product range:

HELLA HEAVY DUTY:

Part Number	Type	Voltage	Wattage	Base	Shape	Luminous Flux (lumens)	Content	Packaging	DOT	ECE	INMETRO
198HD	198	12 V	29/10 W	BAY15d	S8		10	C	■		
5637HD	5637	24 V	10 W	BA15s	B6		10	C		■	■
7510LTS	PY21W	24 V	21 W	BAU15s	S8		10	C			
H3 24V HD	H3	24 V	70 W	PK22s	T3.25	1750	1	C		■	■
H3HD	H3	12 V	55 W	PK22s	T3.25	1450	1	C	■	■	■
◆ H3 24V HDSB	H3	24 V	70 W	P43t	T3.25	1900/1200	1	B		■	■
◆ H3 24V HDTB	H3	24 V	70 W	P43t	T3.25		2	B		■	■
H4 24V HD	H4	24 V	75/70 W	PK22s	T4.625		1	C		■	■
◆ H4 24V HDSB	H4	24 V	75/70 W	PK22s	T4.625		1	B		■	■
◆ H4 24V HDTB	H4	24 V	75/70 W	PK22s	T4.625		2	B		■	■



H4 24V HD

HELLA DOUBLE POWER:

◆ H1 24V DP	H1	24 V	70 W	P14.5s	T2.5		1	C		■	■
◆ H3 24V DP	H3	24 V	70 W	PK22s	T3.25		1	C		■	■
◆ H4 24V DP	H4	24 V	70/75 W	P43t	T4.625		1	C		■	■
◆ H7 24V DP	H7	24 V	70 W	PX26d	T4.625		1	C		■	■
◆ H11 24V DP	H11	24 V	70 W	PGJ19-2	T4		1	C		■	
◆ H1 24V DPSB		24 V	70 W	P14.5s	T2.5		1	B		■	■
◆ H3 24V DPSB		24 V	70 W	PK22s	T3.25		1	B		■	■
◆ H4 24V DPSB		24 V	75/70 W	P43t	T4.625		1	B		■	■
◆ H7 24V DPSB		24 V	70 W	PX26d	T4.625		1	B		■	■
◆ H11 24V DPSB		24 V	70 W	PGJ19-2	T4		1	B		■	



H3HD

PRODUCT RANGE

SPECIAL BULBS



OPTILUX EXTREME YELLOW XY - 12V

The XY Optilux bulbs are designed to give better visibility in extreme weather conditions. Pilots races prefer a yellow light beam, which provides better color contrast in rain and fog situations. The XY Optilux bulbs produce a clear yellow light their filament is made of specific measures to provide the exact amount of light needed in the way.

Features:

- All bulbs are Optilux 12V.
- Two bulbs packed in hard plastic.
- For off-road use

Some examples of the product range:



Part Number	Type	Voltage	Wattage	Base
H71071172	880	12V	27 W	PG13
H71071182	881	12V	27 W	PGJ13
◆ H71071192	893	12V	37.5 W	PG13
◆ H71071462	9006	12V	55 W	P22d**
H71071532	9011	12V	65 W	PX20d
H71071542	9012	12V	55 W	PX22d
H71070642	H1	12V	55 W	P14.5s
◆ H71071112	H10	12V	42 W	PY20d
H71071132	H11	12V	55 W	PGJ19-2
H71071552	H11B	12V	65W	PGJY19-2
H71071152	H13	12V	60/55 W	P26.4t
H71071302	H16	12V	35 W	PG20-3
H71070662	H3	12V	55 W	PK22s
H71071342	H3C	12V	55 W	P22d
H71070682	H4/9003	12V	60/55 W	P43t
H71070702	H7	12V	55 W	PX26d
H71071072	H8	12V	35 W	PGJ19-1
H71071092	H9	12V	65 W	PGJ19-5
H71070562	HB1	12V	65/45 W	P29t
H71070582	HB3	12V	65 W	P20d
H71070602	HB4	12V	55 W	P22d
H71070622	HB5	12V	60/55 W	PX29t



OPTILUX EXTREME WHITE XB - 12V

See the light!

Extreme White bulbs XB Optilux give a radical look at the xenon light in a halogen bulb, with its blue coating. These bulbs incorporate gas xenon bulb improved performance

Features:

- All bulbs are Optilux 12V.
- Two bulbs packed in hard plastic.
- For off-road use



Part Number	Type	Voltage	Wattage	Base	Part Number	Type	Voltage	Wattage	Base
H71071212	880	12V	32 W	PG13	◆ H71071052	H13	12V	100/80 W	P26.4t
H71071222	881	12V	32 W	PGJ13	H71071272	H13	12V	60/55 W	P26.4t
H71071232	893	12V	37.5 W	PG13	H71071282	H16	12V	35 W	PG20-3
H71071392	9004	12V	65/45 W	P29t	H71070227	H2	12V	100 W	P14.5s
H71071402	9005	12V	65 W	P20d	H71070181	H3	12V	100 W	PK22s
H71071412	9005	12V	65 W	P20d**	H71071312	H3	12V	55 W	PK22s
H71071422	9005	12V	100 W	P20d**	H71071322	H3C	12V	55 W	P22d
H71071432	9006	12V	55 W	P22d	H71071332	H3C	12V	80 W	P22d
H71071442	9006	12V	55 W	P22d**	H71070201	H4/9003	12V	100/80 W	P43t
H71071452	9006	12V	80 W	P22d**	H71071352	H4/9003	12V	60/55 W	P43t
H71071472	9007	12V	65/55 W	PX29t	H71070307	H7	12V	100 W	PX26d
◆ H71071492	9011	12V	65 W	PX20d	H71071362	H7	12V	55 W	PX26d
◆ H71071502	9012	12V	55 W	PX22d	H71070772	H8	12V	55 W	PGJ19-1
H71071242	H1	12V	55 W	P14.5s	H71071372	H8	12V	35 W	PGJ19-1
H71071012	H10	12V	65 W	PY20d	H71070792	H9	12V	100 W	PGJ19-5
H71071252	H10	12V	42 W	PY20d	H71071382	H9	12V	65 W	PGJ19-5
H71071032	H11	12V	80 W	PGJ19-2	H71070327	HB1	12V	100/80 W	P29t
H71071262	H11	12V	55 W	PGJ19-2	H71070347	HB3	12V	100 W	P20d
H71071512	H11B	12V	65W	PGJY19-2	H71070367	HB4	12V	80 W	P22d
					H71070387	HB5	12V	100/80 W	PX29t



HELLA has the most complete line of lighting for cars, trucks, buses and now for motorcycles, scooters, mopeds and ATVs.

As original equipment, HELLA is found in most of the car manufacturers, this means that we guarantee 100% light according to the technical standards, offering a long life and in perfect harmony with the whole vehicle. In addition, HELLA halogen bulbs have a UV filter that protects the headlight lens by blocking UV rays, which prevents yellowing of the lens.

BULBS FOR MOTORCYCLES

PRODUCT RANGE

BULBS FOR MOTORCYCLES



BULBS FOR MOTORCYCLES

For the wide range of motorcycles, scooters, mopeds and ATVs, HELLA offers precise solutions according to the requirements of original equipment.

Because it is particularly important for drivers of two-wheel vehicles to see and be seen...

Note:

In headlights, particularly in the case of motorcycles large motor or large displacement is common to find halogen bulbs with identical specification to those of automotive application (H4 60/55, H7 55W, 9006 55W, 9006 HXS 55W, etc.)

Part Number	Type	Voltage	Wattage	Base	Shape	Luminous Flux (lumens)	Content	Packaging	DOT	ECE	INMETRO
880XE-35DB	880	12V	35 W	PG13	T3.25		1	C			
889XE-35DB	894	12V	35 W	PGJ13	T3.25		1	C			
H3 35W	H3	12V	35 W	PK22s	T3.25		1	C			
H8	H8	12V	35 W	PGJ19-1	T4		1	C	■	■	
H8XE-DB	H8	12V	35 W	PGJ19-1	T4		1	C			
HS1	HS1	12V	35 / 35 W	PX43t	T4.625		1	C		■	
H4 35/35W	H4	12V	35/35 W	P43t	T4.625		1	C			
H4 45/45W	H4	12V	45/45 W	P43t	T4.625		1	C			
6235	S2	12V	35/35 W	BA20d	B11		1	C			■
6245	S2	12V	45/40 W	BA20d	B11		1	C			
A3603	3603	12V	25/25 W	PX15d	T6		1	C			
6260	S2	12V	60/60 W	BA20d	B11		1	C			
A3625	3625	6V	25/25 W	PX15d	T6		1	C			
635	F2	12V	35 W	BA20s	B11		1	C			
660	660	12V	60 W	BA20s	B11		1	C			
7951	R2	12V	45/40 W	P45t	S13		1	C			
7952	R2	24V	55/50 W	P45t	S13		1	C			
H9	H9	12V	65 W	PGJ19-5	T4		1	C	■	■	
H11	H11	12V	55 W	PGJ19-2	T4		1	C	■	■	
H11P50	H11	12V	55 W	PGJ19-2	T4		1	C	■	■	
H11LL	H11	12V	55 W	PGJ19-2	T4		1	C	■	■	
H21W	H21W	12V	21 W	BAY9s	T2.75		1	C	■	■	■
H6W	H6W	12V	6 W	BAX9s	T2.75		1	C		■	
2820	2820	12V	2 W	W2.1x9.5d	T3.25		10	C			
2821	2821	12V	3 W	W2.1x9.5d	T3.25		10	C		■	■
2825	2825	12V	5 W	W2.1x9.5d	T3.25		10	C		■	■
2825BL	2825BL	12V	5 W	W2.1x9.5d	T3.25		10	C			
2827NA	2827NA	12V	5 W	W2.1x9.5d	T3.25		10	C			
3652	3652	12V	5 W	W2.1x9.5d	T3.25		10	C		■	■
7440	7440	12V	21 W	W3X16d	T6.5		10	C	■	■	■
7440LL	7440	12V	21 W	W3X16d	T6.5		10	C	■	■	■
7440NA	7440	12V	21 W	W3X16d	T6.5		10	C	■	■	■
7441	7441	12V	27 W	W3X16d	T6.5		10	C	■		
3893	3893	12V	4 W	BA9s	T2.75		10	C	■	■	
194	194	12V	4 W	W2.1x9.5d	T3.25		10	C	■		
194NA	194	12V	4 W	W2.1x9.5d	T3.25		10	C	■		
7507C	7507	12V	21 W	BAU15s	S8		10	C			
7507	7507	12V	21 W	BAU15s	S8		10	C		■	■
2721	2721	12V	1.2 W	W2x4.6d	T1.5		10	C	■		■
◆ M5 35/35W	M5	12V	35/35 W	P15d-25-1		840/805	1	C			
◆ M5 35/35WTB	M5	12V	35/35 W	P15d-25-1		840/805	2	B			
◆ M5 35/35WSB	M5	12V	35/35 W	P15d-25-1		840/805	1	B			
◆ M5 35/35W1	M5	12V	35/35 W	BA20D		840/805	1	C	■		
◆ M5 25/25W	M5	12V	25/25 W	BA20D		540/540	1	C	■		
◆ M5 25/25W1	M5	12V	25/25 W	P15D-25-1		540/540	1	C	■		
◆ M5 18/18W	M5	12V	18/18 W	P15D-25-1		440/440	1	C	■		
◆ M5 35/35W3	M5	12V	35/35 W	P15D-25-3		840/805	1	C	■		
◆ M5 25/25W3	M5	12V	25/25 W	P15D-25-3		540/540	1	C	■		

Some examples of the product range:



6235



660



7951

Displays



Bulbs display

Ask your sales representative for the new HELLAdisplays and get them now!

- Attractive design. Contains 14 cavities to house different sizes of halogen and miniature bulbs
- Includes brackets to hang on the wall
- Measures 44.5 (width) x 17.5 (depth) x 54 (height) cm.
- Made of resistant cardboard.

Part Number	Description
358117581	Bulb display. Dimensions: 44.5x 17.5x 54 cm (17.5 x 6.88 x 21.2")

Bulbs cabinet for miniature bulbs

Ask your sales representative for the new HELLA displays and get them now!

- Manufactured in semi-matt black steel.
- Its compartments come in stackable and individual shapes to maximize organization.
- The miniature bulb dispenser cabinet includes 4 plastic drawers, dividers to make 28 slots for light bulbs
- Storage space "behind" the label
- Durable and elegant design

Part Number	Description
999141848	Cabinet Display. Dimensions: 48.2 x 10.1 x 68.5 cm (18.97 x 3.97 x 26.9")

Blister display

- Manufactured in semi-matt black steel.
- Its 8 hooks allow you to hang up to 40 blisters in total.

Part Number	Description
999140858	Hanging blister display. Dimensions: 52 x 22 x 55.5 cm (20.47 x 8.66 x 21.85")



Halogen bulbs bases

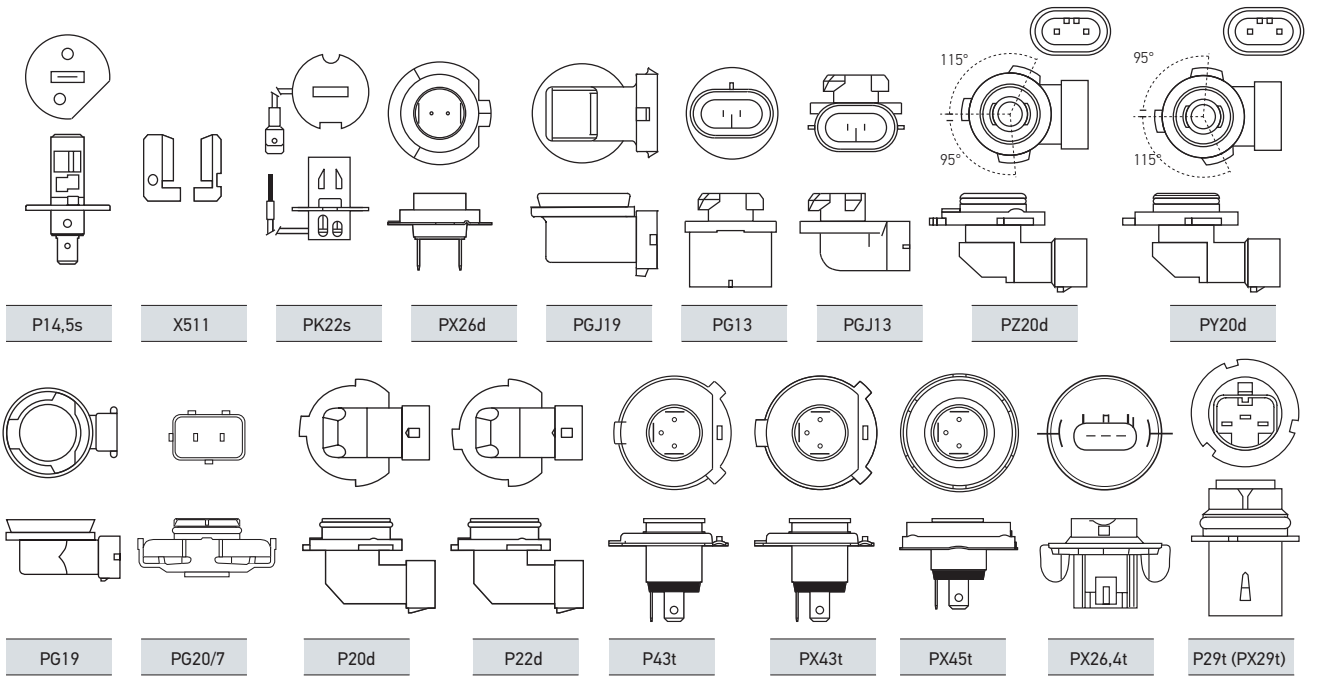

Xenon bulbs bases

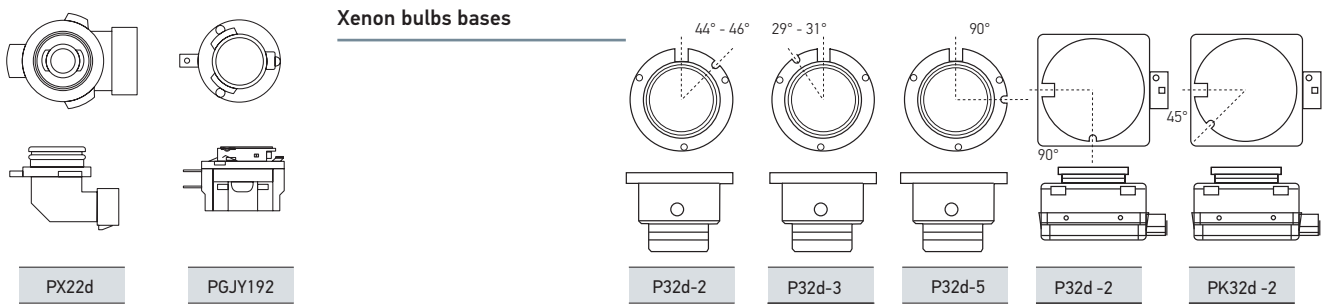

Miniature bulbs bases

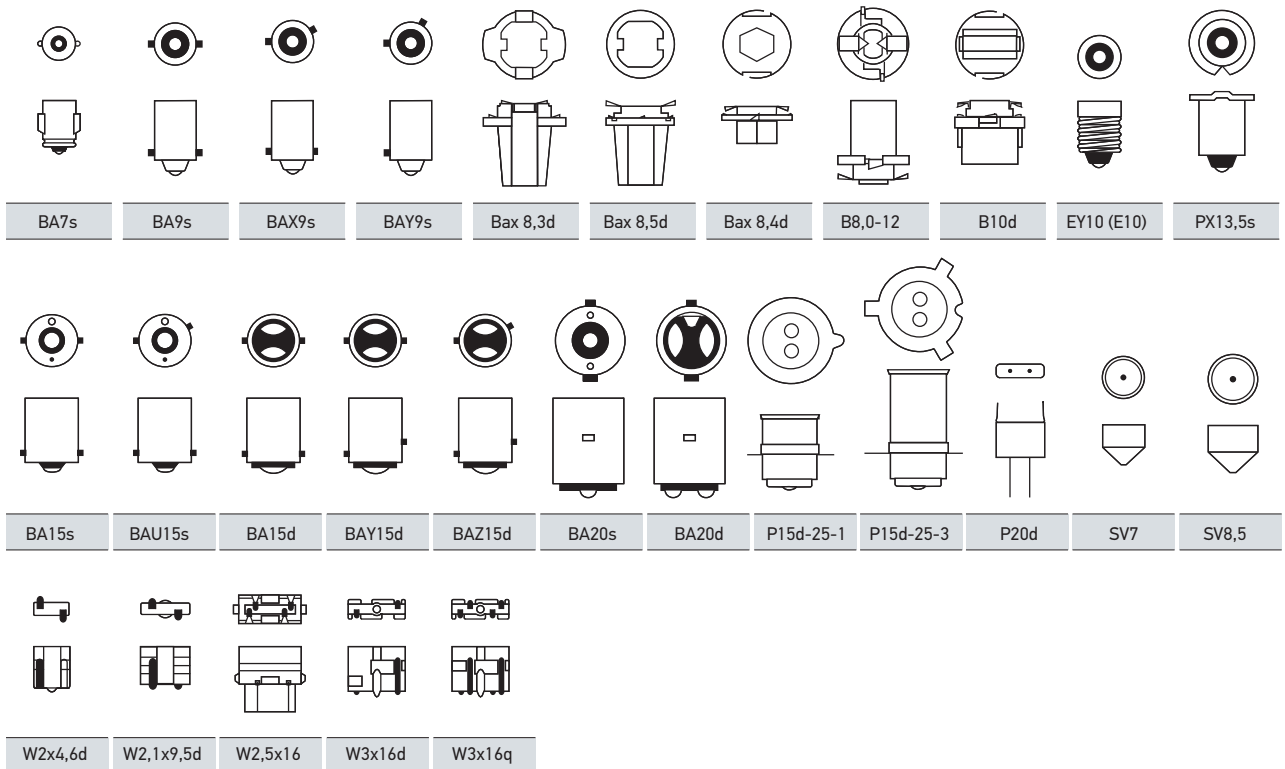

VISIBILITY AND SECURITY

A clear vision at all times



WIPER BLADES

HELLA Wiper Blades are a product with a lot of technology. Effective with fog, snow, ice, insects or dirty water with which cars splash us. They are a key element to ensure optimum visibility, a key factor for driving safety.

Thanks to the graphite coating on the rubber, friction in the contact areas between the blade and the windshield is significantly reduced, allowing for better sliding.

The result: a more uniform and silent operation with a much more lasting performance.



Displays

Ask your sales representative for the HELLA displays!

- Bigger size
- Greater presence
- New design
- Capacity for 25 or 50 wiper blades

Give your business the unmistakable stamp of HELLA, a brand with worldwide recognition.



Part Number	Description
358117501 (208450102)	25 pieces capacity
999942407	50 pieces capacity

APPLICATIONS

Find applications chart and installation videos



www.hella.com/wiperblades

STANDARD WIPER BLADES

E3
(Pre-assembled in all Wiper blades)



STANDARD wiper blades For passenger vehicles

- 1 Rubber sheet with graphite coating for one Homogeneous and silent operation.
- 2 High quality stainless steel frame for better grip and durability.
- 3 Original HELLA logo engraved on the structure as a sign of quality.
- 4 EASYCHANGE, easy replacement thanks to the preassembled universal adapter.
- 5 Thanks to its pressure points, the pressure can be distributed homogeneously.
- 6 Other adapters included.



The HELLA wiper blades are available in 13 lengths and come in a handy blister pack.

New packaging with descriptions in 4 languages.



Dimensions	Part Number	Short Number	Packaging	Adapters Included
11" / 279 mm	9XW398114011	W11STP	Two Pieces	E3, B, E, V9
13" / 330 mm	9XW398114013	W13ST	Single	E3, B, A2-1
14" / 355 mm	9XW398114014	W14ST	Single	E3, B, V9
NEW 14" / 355 mm	9XW398114014/14	W14STP	Two Pieces	E3, B, V9
15" / 381 mm	9XW398114015	W15ST	Single	E3, B, V9
16" / 406 mm	9XW398114016	W16STP	Two Pieces	E3, B, V9
16" / 406 mm	9XW398114016/1	W16ST	Single	E3, B, V9
18" / 457 mm	9XW398114018	W18STP	Two Pieces	E3, B, V9
18" / 457 mm	9XW398114018/1	W18ST	Single	E3, B, V9
19" / 482 mm	9XW398114019	W19ST	Single	E3, B, V9
19/21" 482 / 533 mm	9XW398114019/21	W19STP	Two Pieces	E3, B, V9
20" / 508 mm	9XW398114020	W20ST	Single	E3, V9
NEW 20" / 508 mm	9XW398114020/20	W20STP	Two Pieces	E3, V9
21" / 533 mm	9XW398114021	W21ST	Single	E3, V9
22" / 558 mm	9XW398114022	W22ST	Single	E3, V9
NEW 22" / 558 mm	9XW398114022/22	W22STP	Two Pieces	E3, V9
24" / 609 mm	9XW398114024	W24ST	Single	E3, V9
26" / 660 mm	9XW398114026	W26ST	Single	E3, V9
28" / 711 mm	9XW398114028	W28ST	Single	E3

The packaging includes:

- Part number listed on the back.
- Application table (Manufacturer, model, year of manufacture)
- Length of the wiper blade indicated in inches and millimeters
- EAN and UPC bar codes
- Special adaptors
- Descriptions in 4 languages

CLEANTECH WIPER BLADES

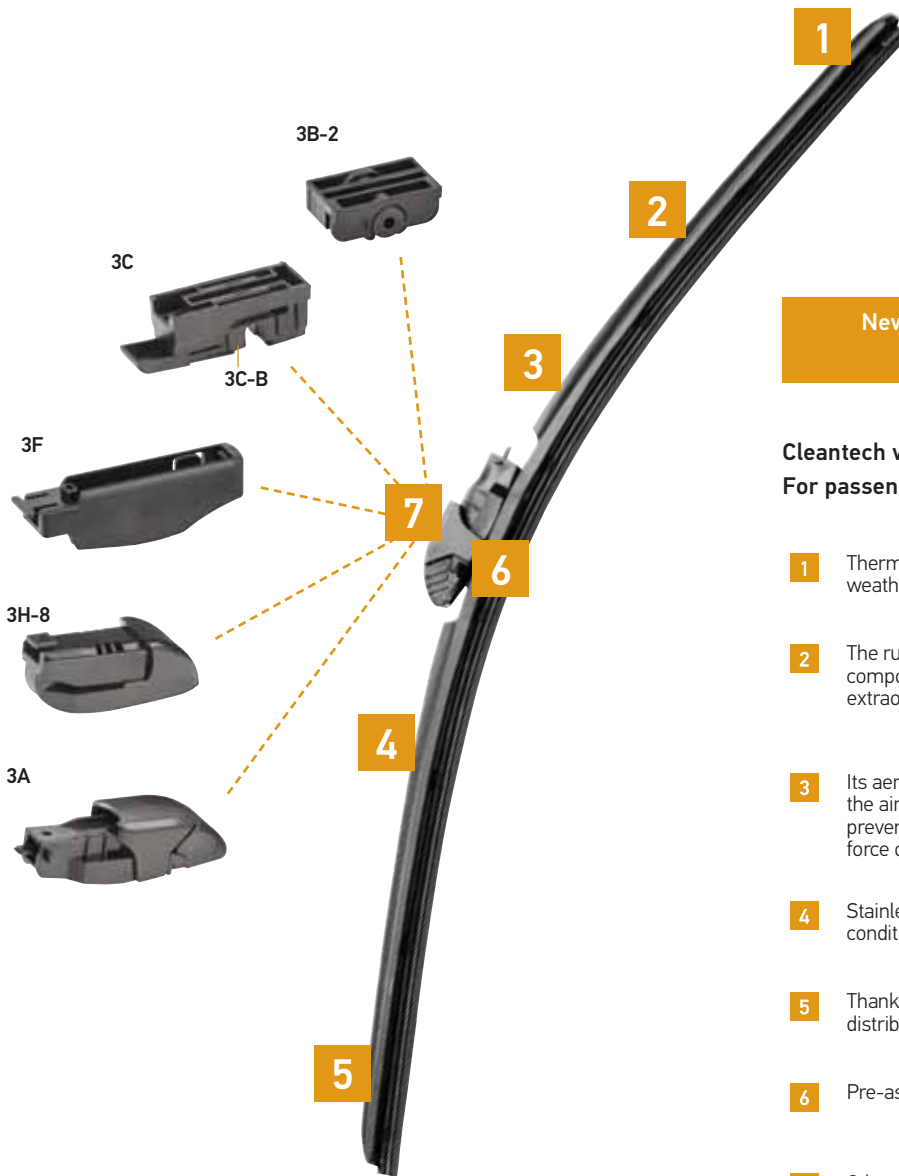

New formulation with graphite nano particles!

Cleantech wiper blades For passenger vehicles

- 1 Thermal plastic spoiler UV resistant and all kinds of weather.
- 2 The rubber is composed of a mixture of special components for the car, with a graphite coating for extraordinary cleaning any time of the year.
- 3 Its aerodynamic structure allows the pressure of the air currents to be directed downwards, thereby preventing the wiper blade from being lifted by the force of the wind.
- 4 Stainless steel frame for optimum elasticity in all conditions of use.
- 5 Thanks to its pressure points, the pressure can be distributed homogeneously.
- 6 Pre-assembled universal adapter.
- 7 Other Adapters Available.



HELLA wiper blades are available in 13 lengths and come in a handy blister.

New image of the packaging with Descriptions in 4 languages.



Dimensions	Part Number	Short Number	Packaging	Adapters Included
14" / 340 mm	358054141	9XW14S	Single	3A, 3H-8, 3B-2,3F, 3C, 3C-B
16" / 406 mm	358054161	9XW16S	Single	3A, 3H-8, 3B-2,3F, 3C, 3C-B
17" / 431 mm	358054171	9XW17S	Single	3A, 3H-8, 3B-2,3F, 3C, 3C-B
18" / 457 mm	358054181	9XW18S	Single	3A, 3H-8, 3B-2,3F, 3C, 3C-B
19" / 482 mm	358054191	9XW19S	Single	3A, 3H-8, 3B-2,3F, 3C, 3C-B
20" / 508 mm	358054201	9XW20S	Single	3A, 3H-8, 3B-2,3F, 3C, 3C-B
21" / 533 mm	358054211	9XW21S	Single	3A, 3H-8, 3B-2,3F, 3C, 3C-B
22" / 558 mm	358054221	9XW22S	Single	3A, 3H-8, 3B-2,3F, 3C, 3C-B
24" / 609 mm	358054241	9XW24S	Single	3A, 3H-8, 3B-2,3F, 3C, 3C-B
26" / 660 mm	358054261	9XW26S	Single	3A, 3H-8, 3B-2,3F, 3C, 3C-B
28" / 711 mm	358054281	9XW28S	Single	3A, 3H-8, 3B-2,3F, 3C, 3C-B

Packaging provides all the necessary information:

- Short number and part number
- Application table (Manufacturer, model, year of production)
- Wiper blade length Indicated in millimeters and inches
- EAN and UPC code
- Descriptions in 4 languages
- QR code with link to installation video

Connectors: Installation Videos

Consult the installation videos of the different Cleantech connectors from your computer, smartphone or tablet.

www.youtube.com/myhellalights



REAR WIPER BLADES



Rear wiper blades For passenger vehicles with special connectors

- 1** Rubber sheet with graphite coating for one homogeneous and silent operation, which greatly improves visibility. Available in 4 lengths 11", 12", 14" and 15".
- 2** High quality stainless steel frame for better grip and durability.
- 3** Original HELLA logo engraved on the structure as a sign of quality.
- 4** EASYCHANGE, easy replacement thanks to universal adapters.
- 5** Thanks to its pressure points, the pressure can be distributed homogeneously.



The original design of the new HELLA rear wiper blades facilitates its installation in vehicles that require special connectors/adaptors.

HELLA Rear wiper blades are available in 4 lengths and come in a practical blister pack.



Dimensions	Part Number	Packaging	Adapters Included
11" / 279 mm	9XW398114011T	Single	5A
12" / 305 mm	9XW398114012T	Single	5A, 5B, 5E
14" / 355 mm	9XW398114014T	Single	5A, 5B, 5C, 5D
16" / 406 mm	9XW398114016T	Single	5A, 5B, 5E

Wiper blade arm types supported

5A	5B	5C	5D / 5E

Original Equipment specifications may vary without notice.

The packaging Includes:

- Part number listed on the back.
- Application table (Manufacturer, model, year of manufacture)
- Length of the wiper blade indicated in inches and millimeters
- EAN and UPC bar codes
- Special adaptors
- Descriptions in 4 languages



The WIPER BLADES suitable for your vehicle can be found on the following page or online using our WIPER BLADES configuration tool at:

www.hella.com/wiperblades.

REAR WIPER BLADES FOR SPECIFIC VEHICLES



Rear wiper blades for specific vehicles with OE adapter

- 1** Rubber sheet with graphite coating for one Homogeneous and silent operation, which greatly improves visibility.
Available in 6 lengths: 10", 12", 13", 14", 15" and 16"
- 2** High quality stainless steel frame for better grip and durability
- 3** Original HELLA logo engraved on the frame as a emblem of quality.
- 4** Original equipment connector for specific applications.
- 5** Thanks to its pressure points, the pressure can be distributed homogeneously.



HELLA rear wiper blades with the Original Equipment adapter are available in 5 lengths and come in a handy blister.

Packaging with descriptions in 4 languages.



Dimensions	Part Number	Packaging
10" / 254 mm	9XW398115010T	Single
12" / 304 mm	9XW398115012T	Single
13" / 330 mm	9XW398115013T	Single
14" / 355 mm	9XW398115014T	Single
15" / 381 mm	9XW398115015T	Single
16" / 406 mm	9XW398115016T	Single

Modifications may exist for modification of Original Equipment without prior notice.

The packaging includes:

- Part number listed on the back.
- Application table (Manufacturer, model, year of manufacture)
- Length of the wiper blade indicated in inches and millimeters
- EAN and UPC bar codes
- Special adaptors
- Descriptions in 4 languages



Wiper blades suitable for your vehicle can be found on the following page or online using our configuration tool at:

www.hella.com/wiperblades.

HEAVY DUTY WIPER BLADES



WIPER BLADES para vehículos pesados con conectores especiales

- 1** Rubber sheet with graphite coating for one Homogeneous and silent operation, which greatly improves visibility.

Available in 8 lengths 20", 22", 24", 26", 28", 32", 36" and 40".
- 2** High quality stainless steel frame for better grip and durability.
- 3** Original HELLA logo engraved on the structure as a sign of quality.
- 4** EASYCHANGE, easy replacement thanks to universal adapters (see below).
- 5** Thanks to its pressure points, the pressure can be distributed homogeneously.



WIPER BLADES

RELATED PRODUCTS

ELECTRICAL WATER PUMPS, 12V

Part Number	Function	Voltage (V)	Design	Delivery flow g / min(l/min)	Pressure (bar)	Cap Part Number	Housing diameter inches (mm)	Inlet diameter inches(mm)	Outlet diameter inches(mm)
004223031	Headlight / windshield	12	Single	0.264 (1)	2	008151021	1.378 (35)	0.276 (7)	0.236 (6)
005496011	Headlight / windshield	12	Single	0.264 (1)	2		1.378 (35)	0.276 (7)	0.236 (6)
005206031	Windshield cleaning	12	Double	0.264 (1)	2	008151021	1.378 (35)	0.276 (7)	0.236 (6)
007540211	Windshield cleaning	12	Single	1.902 (7.2)	2.5	008151021	1.378 (35)	0.453 (11.5)	0.433 (11)
004764021	Headlight cleaning	12	Single	1.902 (7.2)	2.5	008151021	1.378/1.811 (35/46)	0.413 (10.5)	0.433 (11)



ELECTRICAL WATER PUMPS, 24V

Part Number	Function	Voltage (V)	Design	Delivery flow g / min(l/min)	Pressure (bar)	Cap Part Number	Housing diameter inches (mm)	Inlet diameter inches (mm)	Outlet diameter inches(mm)
004764041	Headlight / windshield	24	Single	1.902 (7.2)	2.5	008151021	1.378/1.811 (35/46)	0.413 (10.5)	0.433 (11)
005496051	Windshield cleaning	24	Single	0.264 (1)	2	008151021	1.378 (35)	0.276 (7)	0.236 (6)
007540231	Windshield cleaning	24	Single	1.902 (7.2)	2.5	008151021	1.378 (35)	0.413 (10.5)	0.433 (11)



HEADLIGHT CLEANING SYSTEMS

Part Number	Function	Voltage (V)	Spare part: Pump
008549001	Headlight cleaning system with fixed nozzles	12V	007540211
008549501	Headlight cleaning system with fixed nozzles	24V	007540231

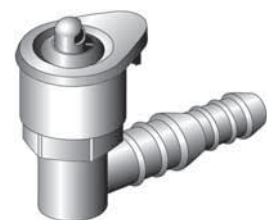

RELAY

Part Number	Function	Voltage (V)	Number of polos	Temperature range °F (°C)	Notes
003620091	Cleaning / Washing Interval	12V	6	-22/185° (-30/+85°)	Without holder

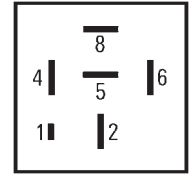

TANK

Part Number	Function	Color	Tank capacity Gal (L)	Voltage	Design	Spare part: Pump	Packing unit
003248001	Washer fluid tank, window	White	0.396 (1.5)	12V	Single	004223031	1 piece
003966047	Washer fluid tank, window	White	2.113 (8)	12V	Single or Double	004223031	24 pieces
003443011	Washer fluid tank, window	White	0.793 (3)	24V	Single	005496051	1 piece
007757047	Washer fluid tank, window	Black	5.283 (20)	24V	Single	005496051	20 pieces

003248001

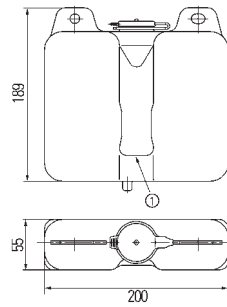

003966047

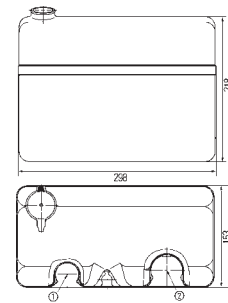

003443011

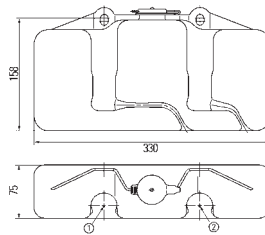

007757047

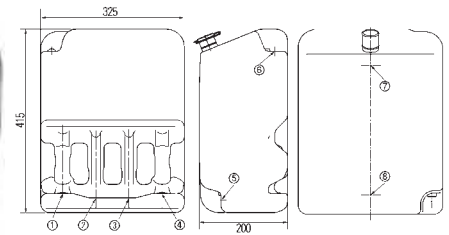

YOUR SAFETY IS OUR PRIORITY



MICROSITE: Find out about
HELLA Electrics range



www.hellahd.com

Quality is extremely important in electric HELLA products such as relays, speakers, switches, flashing lights, electric vacuum pumps, plugs, sockets and much more, due to their high precision and reliability. HELLA products not only comply with the strict legal regulatory requirements but also with the much more demanding requirements made by vehicle manufacturers and the aftermarket.



RELAYERS, FLASHERS, FUSES AND CONTROL DEVICES

Our relays, flashers and controllers are designed to do their job reliably for a long time. And because perfection and durability is one of our strengths to the smallest detail, HELLA offers the most reliable products and one of the widest ranges in this sector: mini-relays, high performance relays, micro relays, relays battery disconnection and solid state relays, for cars, commercial vehicles and trucks; flashers with the classification of a single circuit, flashers of two and three circuits for trucks, vans, commercial vehicles, agricultural and construction machines, time control units and LED light, as well as light switch modules..



ACOUSTIC SIGNAL UNITS

A security product that does not require many words: horns, bugles and trumpets. Whether you choose the harmonic sound of the two-tone electric disc horn or the penetrating sound of our supertone bugles, your customers will surely be able to be noticed.

The trumpets of pressurized air; Our warning signs are always at the forefront. We have been integrating reliability and precision for over 100 years. At HELLA, security simply has tradition.

HORNS APP - Online tool to compare the different acoustic signal units



www.hella.com/apps

ELECTRICS - HORNS SUMMARY

Series	HELLA Part No.	Frequency	Acoustic Intensity	Voltage	Energy consumption	Diameter / Size	Packaging / Content						
S70M 	012588011	380 / 480 Hz	108 dB (A)	12 V	2 x 16 W	7 cm 7 x 9.5 cm	Box - 2 items	■					
	012588061	480 Hz	108 dB (A)	12 V	1 x 16 W		Blister - 1 item	■					
S77 	011225802	350 / 420 Hz	111 dB (A)	12 V	2 x 42 W	7.7 cm 4.7 x 10.5 cm	Box - 2 items	■	■	■			
	011225881	350 / 420 Hz	111 dB (A)	12 V	2 x 42 W		Box - 2 items		Toyota				
	011225891	350 / 420 Hz	111 dB (A)	12 V	2 x 42 W		Box - 2 items		Honda				
	011225101	420 Hz	111 dB (A)	12 V	1 x 42 W		Blister - 1 item	■	■	■			
	011225102	420 Hz	111 dB (A)	12 V	1 x 42 W		Box - 1 item	■	■	■			
S92 	011225871	335 / 435 Hz	113 db (A)	12 V	2 x 60 W	9.2 cm 9.2 x 5.6 cm	Box - 2 items	■	■	■			
	012588071	435 Hz	113 db (A)	12 V	1 x 60 W		Blister - 1 item	■	■	■			
	002768821	335 / 435 Hz	113 db (A)	24 V	2 x 72 W		Box - 2 items	■	■	■			
	012588141	335 Hz	113 db (A)	12 V	1 x 60 W		Blister - 1 item	■	■	■			
M26 	002952811	400 Hz	115 db (A)	12 V	1 x 66 W	9.7 cm 5.4 x 12.2 cm	Box - 1 item		■	■			
	002952861	335 Hz	115 db (A)	12 V	1 x 66 W		Box - 1 Piece		■	■			
	006958901	335 Hz	115 db (A)	12 V	1 x 66 W		Box - 1 item (Black)		■	■			
B36 	002768082	335 Hz	116 db (A)	12 V	1 x 72 W	11.2 cm 5.3 x 12.9 cm	Box - 1 item		■	■			
	002768551	400 Hz	116 db (A)	12 V	1 x 72 W		Box - 1 item		■	■			
	002768382	335 Hz	116 db (A)	24 V	1 x 72 W		Box - 1 item		■	■			
	002768431	400 Hz	116 db (A)	24 V	1 x 72 W		Box - 1 item		■	■			
S130 	004811091	280 / 380 Hz	118 dB (A)	12 V	2 x 48 W	13 cm 13 x 8.1 cm	Box - 2 items		■	■	■	■	
	004811071	280 / 380 Hz	118 dB (A)	24 V	2 x 48 W		Box - 2 items		■	■	■	■	
S140 	004811101	280 / 380 Hz	118 dB (A)	12 V	2 x 48 W	14 cm 14 x 8.2 cm	Box - 2 items		■	■	■	■	
	004811081	280 / 380 Hz	118 dB (A)	24 V	2 x 48 w		Box - 2 items		■	■	■	■	
M26S 	922000731	350 / 415 Hz	115 db (A)	12 V	2 x 42 W	10.8 cm 6.65 x 12.2 cm	Box - 2 items		■	■	■	■	
B133 	003399801	300 / 500 Hz	118 db (A)	12 V	2 x 66 W	12.3 cm 8.5 x 12.5 cm	Box - 2 items + Relay		■	■	■	■	
	003399901	300 / 500 Hz	118 db (A)	12 V	2 x 66 W		Blister - 2 items + Relay		■	■	■	■	
	358114051	500 Hz	118 db (A)	12 V	1 x 66 W		Box - 1 item		■	■	■	■	
B133 	003399101	375 / 500 Hz	118 db (A)	24 V	2 x 84 W	12.3 cm 8.5 x 12.5 cm	Box - 2 items		■	■	■	■	
	003399061	375 Hz	118 dB (A)	24 V	1 x 84 W		Box - 1 item		■	■	■	■	
	003399071	500 Hz	118 dB (A)	24 V	1 x 84 W		Box - 1 item		■	■	■	■	
DL50 	004811001	310 Hz	114 dB (A)	12 V	1 x 72 W	13 cm 6.1 x 14.3 cm	Box - 1 item		■	■	■	■	
	004811011	380 Hz	114 dB (A)	12 V	1 x 72 W		Box - 1 item		■	■	■	■	
	004811021	310 Hz	114 dB (A)	24 V	1 x 84 W		Box - 1 item		■	■	■	■	
	004811031	380 Hz	114 dB (A)	24 V	1 x 84 W		Box - 1 item		■	■	■	■	
TC16 	011225831	400 / 500 Hz	113 dB (A)	12 V	2 x 72 W	8.6 cm 8.6 x 10.9 cm	Box - 2 items	■	■	■			
	012010971	400 / 500 Hz	113 dB (A)	12 V	2 x 72 W		Blister - 2 items	■	■	■			

Series	 Part No.	 Frequency	 Acoustic Intensity	 Voltage	 Energy consumption	 Diameter / Size	 Packaging / Content						
TE16 	012010981	400 / 500 Hz	110 db (A)	12 V	2 x 72W	8.1 cm 8.1 x 10.9 cm	Box - 2 items + Relay	■	■	■			
	007424801	400 / 500 Hz	110 db (A)	12 V	2 x 72W		Box - 2 items + Relay	■	■	■			
	012010851	400 / 500 Hz	110 db (A)	12 V	2 x 72 W		Box - 2 items	■	■	■			
	007424811	400 / 500 Hz	110 db (A)	12 V	2 x 72 W		Box - 2 items	■	■	■			
	012010801	400 / 500 Hz	110 db (A)	12 V	2 x 72 W		Box - 2 items	■	■	■			
	012010821	400 / 500 Hz	110 db (A)	12 V	2 x 72 W		Box - 2 items	■	■	■			
	007424001	400 Hz	110 db (A)	12 V	1 x 72 W		Box - 1 Pieces..	■	■	■			
	007424011	400 Hz	110 db (A)	12 V	1 x 72 W		Box - 1 Pieces.	■	■	■			
TC16S  <div style="background-color: red; color: white; padding: 2px; font-size: 8px;">Specific Applications</div>	011225841	400 / 500 Hz	113 db (A)	12 V	2 x 72 W	8.6 cm 8.6 x 10.9 cm	Box - 2 items		Audi, Seat VW				
	012010881	400 / 500 Hz	113 db (A)	12 V	2 x 72 W		Box - 2 items		BMW				
	011225921	400 / 500 Hz	113 db (A)	12 V	2 x 72 W		Box - 2 items		Ford				
	012010911	400 / 500 Hz	113 db (A)	12 V	2 x 72 W		Box - 2 items		Honda				
	011225901	400 / 500 Hz	113 db (A)	12 V	2 x 72 W		Box - 2 items		Hyundai				
	012010891	400 / 500 Hz	113 db (A)	12 V	2 x 72 W		Box - 2 items		Peugeot				
	012010901	400 / 500 Hz	113 db (A)	12 V	2 x 72 W		Box - 2 items		Toyota				
	011225851	400 / 500 Hz	113 db (A)	12 V	2 x 72 W		Box - 2 items		VW				
TE20C 	007728883	410 / 510 Hz	112 db (A)	12 V	2 x 60 W	8.6 cm 9.1 x 9.7 cm	Box - 2 items	■	■	■	■	■	
TE20 	940800821	410 / 510 Hz	110 db (A)	24 V	2 x 72 W	8.6 cm 9.1 x 9.7 x 8.7	Box - 1 Piece				■	■	
Highway Trumpet 	005411001	300 - 350 Hz	118 dB (A)	24 V	0 - 20 W	8 cm 7.8 x 16 x 41.5	Box - 1 item				■	■	
Air Compressor Trumpet 	004206041	400 Hz	118 dB (A)	12 V	35 W	11.9 cm 9.7 x 9 x 31.1	Box - 1 item				■	■	
	004206011	400 Hz	118 dB (A)	24 V	50 W		Box - 1 item				■	■	
Double Tone Air Trumpet 	003001651	780 / 840 Hz	118 dB (A)	12 V	240 W	16.3 cm 21.2 cm (longitudes)	Blister - 1 Set.			■	■	■	
	003001661	780 / 840 Hz	118 dB (A)	24 V	240 W		Blister - 1 Set.			■	■	■	
Triple Tone Air Trumpet 	003001671	780/820/880	118 dB (A)	12 V	240 W	15.8 cm 16.6 cm 21.7 cm (longitudes)	Blister - 1 Set.			■	■	■	
	003001681	630/795/840	118 dB (A)	12 V	240 W		Blister - 1 Set.			■	■	■	
Air Compressor Horn 	013410001	-	115 dB (A)	12 V	312 W	9.2 x 8.4 x 38.6	Blister - 1 Set.				■	■	
Chrome Double Air Horn 	013410051	-	125 dB (A)	12 V	41 W	40.2x9.6 x 15.6	Box - 1 item				■	■	
	013410061	-	125 dB (A)	24 V	77 W		Box - 1 item				■	■	
Single-tone air horn 	013410011	-	115 dB (A)	12 V 24 V	120 W	11.6x14.4x20.3	Box - 1 item				■	■	
Backup Alarm 	009148142	1200 Hz	110 dB (A)	9 - 28 V	5.5 W	10.1x39x65	Blister - 1 item		■	■	■	■	
	009148141	1200 Hz	110 dB (A)	9 - 28 V	5.5 W		Box - 1 item		■	■	■	■	
	009148161	1200 Hz	110 dB (A)	9 - 28 V	5.5 W		Box - 1 item		■	■	■	■	
	009148221	1200 Hz	107 dB (A)	9 - 28 V	5.5 W		Box - 1 item		■	■	■	■	
Backup Alarm 	996139001	1200 Hz	87 dB (A)	12 - 36 V	0.59 A	18x78x102	Box - 1 item		■	■	■	■	
	996139101	1300 Hz	107 dB (A)	12 - 36 V	0.4 A		Box - 1 item		■	■	■	■	
	996139111	1250 Hz	112 dB (A)	12 - 36 V	0.4 A		Box - 1 item		■	■	■	■	
Backup Alarm 	009148001	1250 Hz	90 dB (A)	12 - 24 V	0.2 A	10.1 x 6 x 7.4	Box - 1 item		■	■	■	■	
	009148011	1250 Hz	97 dB (A)	12 - 24 V	0.4 A		Box - 1 item		■	■	■	■	
	009148021	1250 Hz	107 dB (A)	12 - 24 V	0.7 A		Box - 1 item		■	■	■	■	

Product image /
Dimensions

Features

S70M Series - Horns for Motorcycles



Housing and bracket in black galvanized metal.
Level of acoustic intensity at 2 m distance: 108 dB (A).
Energy consumption: 16 W.
M8 screw horn bracket.
Operating Temperature: -40° C a 90° C (-40°F a 194°F)
Approval: ECE

380 / 480 Hz 108 dB (A) 12 V-
7 cm (2.75") 2 x 16 W ECE R28



2 Pieces



1 Piece

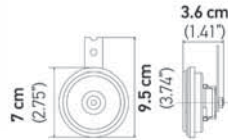

Part No.	Quantity	Description
012588011	2 Pieces	Horns Box (graphic) 12 V, 2 x 16 W, 380 / 480 Hz - Universal Diameter Measurements: 7 cm 7 x 9.5 cm
012588061	1 Piece	High Tone - Plastic blister Horn 12 V, 16 W, 480 Hz - Universal Diameter Measurements: 7 cm 7 x 9.5 cm

S77 Series - Compact Horns



Housing and bracket in black galvanized metal.
Level of acoustic intensity at 2 m distance: 111 dB (A).
Energy consumption: 2 x 42 W
M8 screw horn bracket.
Operating Temperature: -40° C a 90° C (-40°F a 194°F)
With flat connections of 6.3 mm, open, blade type
With Teflon gasket as protection against moisture.
Approval: ECE R28

350 / 420 Hz 111 dB (A) 12 V-
7.7 cm (3.03") 2 x 42 W ECE R28

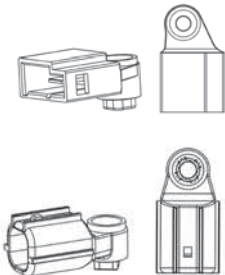

2 Pieces



1 Piece



1 Piece

Part No.	Quantity	Description
011225802	2 Pieces	Box (graphic) Horns 12 V, 2 x 42 W, 350/420 Hz - Universal Diameter Measurements: 7.7 cm 4.7 x 10.5 cm
011225101	1 Piece	High Tone - Plastic blister Horn 12 V, 1 x 42 W, 420 Hz - Universal Diameter Measurements: 7.7 cm 4.7 x 10.5 cm Individual presentation in blister pack
011225102	1 Piece	High Tone - Box (graphic) Horn 12 V, 1 x 42 W, 420 Hz - Universal Diameter Measurements: 7.7 cm 4.7 x 10.5 cm Individual presentation in Box
011225881	2 Pieces	Horns 12 V, 2 x 42 W, 350/420 Hz - TOYOTA Diameter Measurements: 7.7 cm 4.7 x 10.5 cm With specific connector for Toyota
011225891	2 Pieces	Horns 12 V, 2 x 42 W, 350/420 Hz - HONDA Diameter Measurements: 7.7 cm 4.7 x 10.5 cm With specific connector for Honda

Product image /
Dimensions

Features



2 Piece



1 Piece

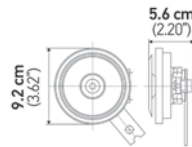

S92 Series



Housing, diaphragm and bracket in black galvanized metal.
Level of acoustic intensity at 2 m distance: 113 dB (A).
Energy consumption: 2 x 60 W @ 12 V | 2 x 72 W @ 24 V
M8 screw horn bracket.
Operating Temperature: -40° C a 90° C (-40°F a 194°F).
With flat connections of 6.3 mm, open, blade type.
Approval: CCC



Part No.	Quantity	Description
011225871	2 Pieces	Box (graphic) Horns 12 V, 2 x 60 W, 335/435 Hz - Universal Diameter Measurements: 9.2 cm 9.2 x 5.6 cm
002768821	2 Pieces	Box (graphic) Horns 24 V, 2 x 72 W, 335/435 Hz - Universal Diameter Measurements: 9.2 cm 9.2 x 5.6 cm
012588071	1 Piece	High Tone - Plastic blister Horn 12 V, 1 x 60 W, 435 Hz - Universal Diameter Measurements: 9.2 cm 9.2 x 5.6 cm
012588141	1 Piece	Low Tone - Plastic blister Horn 12 V, 1 x 60 W, 335 Hz - Universal Diameter Measurements: 9.2 cm 9.2 x 5.6 cm

ELECTRICS



002952811 / 002952861



006958901



1 Piece

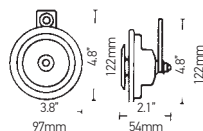

M26 Series



Housing and bracket in galvanized metal, black diaphragm
Level of acoustic intensity at 2 m distance: 115 dB (A).
Energy consumption: 66 W.
M8 screw horn bracket.
Operating Temperature: -40° C a 90° C (-40°F a 194°F)
With flat connections of 6.3 mm, open, blade type
Approval: ECE R28



Part No.	Quantity	Description
002952811	1 Piece	High tone Horn 12 V, 66 W, 400 Hz - Universal, silver Diameter Measurements: 9.7 mm 5.4 x 12.2 cm
002952861	1 Piece	Low Tone Horn 12 V, 66 W, 335 Hz - Universal, silver Diameter Measurements: 9.7 mm 5.4 x 12.2 cm
006958901	1 Piece	Low Tone Horn 12 V, 66 W, 335 Hz - Universal, black Diameter Measurements: 9.7 mm 5.4 x 12.2 cm

Product image / Dimensions

Features



B36 Series

Housing and bracket in galvanized metal, black diaphragm
 Level of acoustic intensity at 2 m distance: 116 dB (A).
 Energy consumption: 72 W.
 M8 screw horn bracket.
 Operating Temperature: -40° C a 90° C (-40°F a 194°F)
 Approval: ECE R28



1 Piece

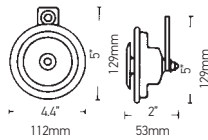

Part No.	Quantity	Description
		Low Tone
002768082	1 Piece	Horn 12 V, 72 W, 335 Hz - Universal Diameter Measurements: 11.2 cm 5.3 x 12.9 cm
002768551	1 Piece	High Tone Horn 12 V, 72 W, 400 Hz - Universal Diameter Measurements: 11.2 cm 5.3 x 12.9 cm
002768382	1 Piece	Low Tone - 24 V Horn 24 V, 72 W, 335 Hz - Universal Diameter Measurements: 11.2 cm 5.3 x 12.9 cm
002768431	1 Piece	High Tone - 24 V Horn 24 V, 72 W, 400 Hz - Universal Diameter Measurements: 11.2 cm 5.3 x 12.9 cm



S130 Series

Distinctive look and heavy-duty design
 Level of acoustic intensity at 2 m distance: 118 dB(A).
 Embedded HELLA Logo on the center of the grille
 Black coated housing with a chromed protective grille
 Enhanced low bass sound
 Available for 12 V and 24 V
 Operating Temperature: -40° C a 90° C (-40°F a 194°F)



2 Pieces

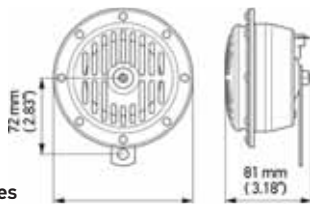

Part No.	Quantity	Description
004811091	2 Pieces	Box (graphic) Horn 12 V, 2 x 48 W, 280/380 Hz - Universal Diameter Measurements: 13 cm 13 x 8.1 cm
004811071	2 Pieces	Box (graphic) Horn 24 V, 2 x 48 W, 280/380 Hz - Universal Diameter Measurements: 13 cm 13 x 8.1 cm



S140 - Set of Horns

Housing and bracket in galvanized metal, black diaphragm
 Level of acoustic intensity at 2 m distance: 118 dB (A).
 Energy consumption: 2 x 48 W.
 M8 screw horn bracket.
 Operating Temperature: -40° C a 90° C (-40°F a 194°F)
 Approval: ECE R28

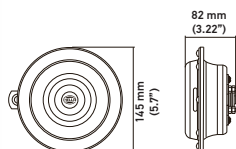

Part No.	Quantity	Description
004811101	2 Pieces	Horns 12 V, 2 x 48 W, 280 / 380 Hz - Universal Diameter Measurements: 14.4 cm 14.4 x 82.4 cm
004811081	2 Pieces	Horns 12 V, 2 x 48 W, 280 / 380 Hz - Universal Diameter Measurements: 14.4 cm 14.4 x 82.4 cm

Product image /
Dimensions

Features

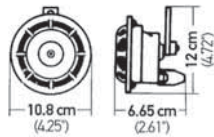

M26S Series - Set of Horns

Black housing and bracket, yellow protective grid and blue diaphragm in galvanized metal.
Level of acoustic intensity at 2 m distance: 115 dB(A).
Energy consumption: 2 x 42 W.
M8 screw horn bracket.
Operating Temperature: -40° C a 90° C (-40°F a 194°F)
With flat connections of 6.3 mm, open, blade type
Approval: ECE R28



Part No.	Quantity	Description
922000731	2 Pieces	Horns 12 V, 2 x 42 W, 350 / 415 Hz - Universal Diameter Measurements: 10.8 cm 6.65 x 12.2 cm



2 Pieces
1 Relay

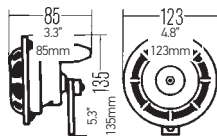

2 Pieces
1 Relay

1 Piece

B133 Series - Supertone Horns with 12 V Relay

Extremely concentrated sound radiation and powerful range. Particularly suitable for traffic on motorways.

Black housing, diaphragm and bracket, red protective grille, in galvanized metal.
Level of acoustic intensity at 2 m distance: 118 dB(A).
Energy consumption: 2 x 66 W
M8 screw horn bracket.
Operating Temperature: -40° C a 90° C (-40°F a 194°F)
With flat connections of 6.3 mm, open, blade type
Approval: ECE R28



Part No.	Quantity	Description
003399901	2 Pieces	Plastic blister Horns 12 V, 2 x 66 W, 300/500 Hz - Universal Diameter Measurements: 12.3 cm 8.5 x 12.5 cm
	1 Piece	Includes 12 V Relay
003399801	2 Pieces	Box (graphic) Horns 12 V, 2 x 66 W, 300/500 Hz - Universal Diameter Measurements: 12.3 cm 8.5 x 12.5 cm
	1 Piece	Includes 12 V Relay
358114051	1 Piece	High Tone - Box (yellow) Horn 12 V, 1 x 66 W, 500 Hz - Universal Diameter Measurements: 12.3 cm 8.5 x 12.5 cm



2 Pieces

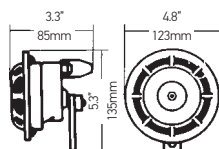

B133 Series - Set of Supertone Horns

Black housing, protective grille and bracket, in galvanized metal.
Level of acoustic intensity at 2 m distance: 118 dB(A).
Energy consumption: 2 x 84 W @ 24 V
M8 screw horn bracket.
Operating Temperature: -40° C a 90° C (-40°F a 194°F)
With flat connections of 6.3 mm, open, blade type
Approval: ECE R28



Part No.	Quantity	Description
003399101	2 Pieces	Horns 24 V, 2 x 84 W, 375/500 Hz - Universal Diameter Measurements: 12.3 mm 8.5 x 12.5 cm
003399061	1 Piece	Low Tone Horns 24 V, 1 x 84 W, 375 Hz - Universal Diameter Measurements: 12.3 cm 8.5 x 12.5 cm
003399071	1 Piece	High Tone Horns 24 V, 1 x 84 W, 500 Hz - Universal Diameter Measurements: 12.3 cm 8.5 x 12.5 cm

Product image / Dimensions

Features



DL50 Series

Black housing and bracket in galvanized metal.
 Level of acoustic intensity at 2 m distance: 114 dB(A).
 Energy consumption: 72 W
 M8 screw horn bracket.
 Operating Temperature: -40° C a 90° C (-40°F a 194°F)
 With flat connections of 6.3 mm, open, blade type
 Approval: ECE R28

Part No.	Quantity	Description
004811001	1 Piece	Low Tone Horn 12 V, 72 W, 310 Hz - Universal Diameter Measurements: 13 cm 6.1 x 14.3 cm
004811011	1 Piece	High Tone Horn 12 V, 72 W, 380 Hz - Universal Diameter Measurements: 13 cm 6.1 x 14.3 cm
004811021	1 Piece	Low Tone Horn 24 V, 84 W, 310 Hz - Universal Diameter Measurements: 13 cm 6.1 x 14.3 cm
004811031	1 Piece	High Tone Horn 24 V, 84 W, 380 Hz - Universal Diameter Measurements: 13 cm 6.1 x 14.3 cm



1 Piece

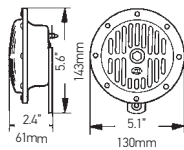

TC16 Series

ABS plastic housing and galvanized metal bracket
 Level of acoustic intensity at 2 m distance: 113 dB(A).
 Energy consumption: 2 x 72 W.
 M8 screw horn bracket.
 Operating Temperature: -40° C a 90° C (-40°F a 194°F)
 With flat connections of 6.3 mm, open, blade type
 Approval: CCC

Part No.	Quantity	Description
011225831	2 Pieces	Box (graphic) Trumpets 12 V, 2 x 72 W, 400 / 500 Hz - Universal Diameter Measurements: 8.6 cm 8.6 x 10.9 cm
012010971	2 Pieces	Plastic blister Horn 12 V, 2 x 72 W, 400 / 500 Hz - Universal Diameter Measurements: 8.6 cm 8.6 x 10.9 cm



2 Pieces



2 Pieces

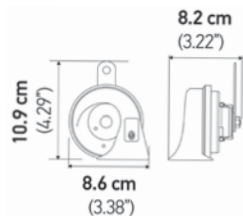

Product image / Dimensions

Features



TE16 Series - Set of Twin Tone Trumpet Horns with 12 V Relay

ABS plastic housing and black bracket in galvanized metal.
 Level of acoustic intensity at 2 m distance: 110 dB(A).
 Energy consumption: 2 x 72 W.
 M8 screw horn bracket.
 Operating Temperature: -40° C a 90° C (-40°F a 194°F)
 With flat connections of 6.3 mm, open, blade type
 Approval: ECE R28
 Includes 12 V Relay



2 Pieces
1 Relay

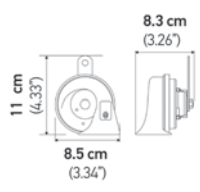

Part No.	Quantity	Description
007424801	2 Pieces	Trumpets 12 V, 2 x 72 W, 400 / 500 Hz - Universal Diameter Measurements: 8.1 cm 8 x 10.9 cm Red Horn
	1 Piece	Includes 12 V Relay



TE16 Series - Set of Trumpets

ABS plastic housing and black bracket in galvanized metal.
 Level of acoustic intensity at 2 m distance: 110 dB(A).
 Energy consumption: 2 x 72 W.
 M8 screw horn bracket.
 Operating Temperature: -40° C a 90° C (-40°F a 194°F)
 With flat connections of 6.3 mm, open, blade type
 Approval: ECE R28



1 Piece



2 Pieces

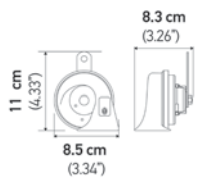

Part No.	Quantity	Description
012010801	2 Pieces	Box (graphic) Trumpets 12 V, 2 x 72 W, 400 / 500 Hz - Universal Diameter Measurements: 8.1 cm 8 x 10.9 cm Blue Horn
012010821	2 Pieces	Box (graphic) Trumpets 12 V, 2 x 72 W, 400 / 500 Hz - Universal Diameter Measurements: 8.1 cm 8 x 10.9 cm Yellow Horn
007424001	1 Piece	Low Tone - Box (yellow) Horn 12 V, 1 x 72 W, 400 - Universal Diameter Measurements: 8.1 cm 8 x 10.9 cm Red Horn
007424011	1 Piece	High Tone - Box (yellow) Horn 12 V, 1 x 72 W, 500 - Universal Diameter Measurements: 8.1 cm 8 x 10.9 cm Red Horn

Product image /
Dimensions

Features



TC16S Series - OE Connector



ABS plastic housing and black bracket in galvanized metal.
Level of acoustic intensity at 2 m distance: 113 dB(A).
Energy consumption: 2 x 72 W.
M8 screw horn bracket.
Operating Temperature: -40° C a 80° C (-40°F a 176°F)
With flat connections of 6.3 mm, open, blade type
Approval: ECE R28, CCC

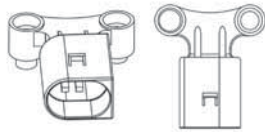

Part No.	Quantity	Description
011225841	2 Pieces.	Horns 12 V, 2 x 72 W, 400 / 500 Hz - AUDI / VOLKSWAGEN Diameter Measurements: 8.6 cm 8.6 x 10.9 cm With specific connector
012010881	2 Pieces.	Horns 12 V, 2 x 72 W, 400 / 500 Hz - BMW / MINI Diameter Measurements: 8.6 cm 8.6 x 10.9 cm With specific connector
011225921	2 Pieces.	Horns 12 V, 2 x 72 W, 400 / 500 Hz - FORD Diameter Measurements: 8.6 cm 8.6 x 10.9 cm With specific connector
012010911	2 Pieces.	Horns 12 V, 2 x 72 W, 400 / 500 Hz - HONDA Diameter Measurements: 8.6 cm 8.6 x 10.9 cm With specific connector
011225901	2 Pieces.	Horns 12 V, 2 x 72 W, 400 / 500 Hz - HYUNDAI / KIA Diameter Measurements: 8.6 cm 8.6 x 10.9 cm With specific connector
012010891	2 Pieces.	Horns 12 V, 2 x 72 W, 400 / 500 Hz - PEUGEOT Diameter Measurements: 8.6 cm 8.6 x 10.9 cm With specific connector
012010901	2 Pieces.	Horns 12 V, 2 x 72 W, 400 / 500 Hz - TOYOTA Diameter Measurements: 8.6 cm 8.6 x 10.9 cm With specific connector
011225851	2 Pieces.	Horns 12 V, 2 x 72 W, 400 / 500 Hz - AUDI / VOLKSWAGEN Diameter Measurements: 8.6 cm 8.6 x 10.9 cm With specific connector

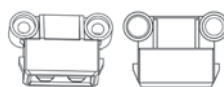
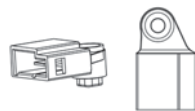
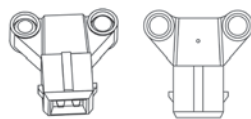
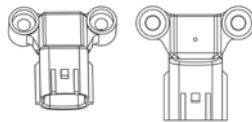
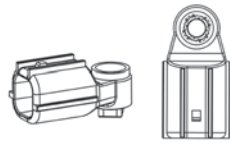
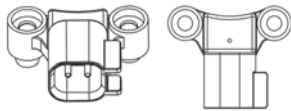

2 Pieces

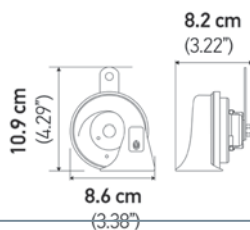

Product image /
Dimensions

Features



TE20C Series - Chrome

Chromed ABS plastic housing and galvanized metal bracket.
 Level of acoustic intensity at 2 m distance: 112 dB(A).
 Energy consumption: 2 x 60 W
 M8 screw horn bracket.
 Operating Temperature: -40° C a 90° C (-40°F a 194°F).
 With flat connections of 6.3 mm, open, blade type.



Special Edition

Horn chrome HELLA:
Quality to the last detail



2 Pieces

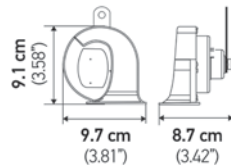

Series TE20

ABS plastic housing and galvanized metal bracket.
 Level of acoustic intensity at 2 m distance: 110 dB(A)
 Energy consumption: 2 x 72 W
 M8 screw horn bracket.
 Operating Temperature: -40° C a 90° C (-40°F a 194°F)
 With flat connections of 6.3 mm, open, blade type



2 Pieces

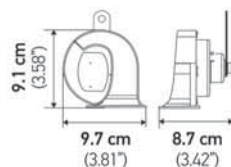

Part No.	Quantity	Description
940800821	2 Pieces	Trumpets 24 V, 2 x 72 W, 410 / 510 Hz - Universal Diameter Measurements: 8.6 cm 9.1 x 9.7 x 8.7 cm Black Horn

AIR TRUMPETS

Efficient sound

HELLA compressed air trumpets produce a penetrating and long range sound. Ideal for carriers that need to be heard in traffic.

HELLA trumpets are finished in durable materials, their sound is penetrating, and their design is striking, resistant to inclement weather



ACOUSTIC SIGNAL UNITS

COMPRESSED AIR HORNS AND TRUMPET HORNS

Product image / Dimensions

Features



Twin Compressed Air Trumpet

For vehicles with a compressed air brake system.
 Chromed lid and trumpet, matt black base
 Pneumatic operation
 Level of acoustic intensity at 2 m distance: 118 dB(A).
 Energy consumption: 0 - 20 W.
 Suitable for tubular fittings Ø 8 mm.
 2 holes for fixing screws M10.
 Approval: ECE
 Pressure Range: 4 - 8.3 bar

300 / 350 Hz 118 dB(A) 24 V-
 8 cm (máx.) (3.14") 0 - 20 W ECE R28

Part No.	Quantity	Description
005411001	1 Piece	Compressed air horn 24 V, 0 - 20 W, 300 - 350 Hz - Universal Measurements: 7.8 x 16 x 41.5 cm

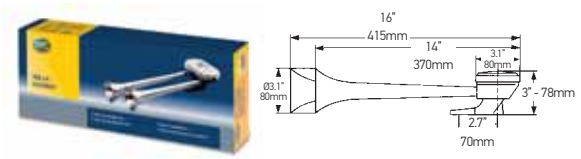

1

2

3

Accessories

The horn can be operated in three different ways:

Part No.	Quantity	Description
1 715989001	1 Set	Mounting on the roof of the cab. Drive pulling the pull cable coated, 120 cm long. Traction Valve.
2 715990001	1 Set	Cabin floor mounting. Actuation with the foot. Pedal valve.
3 715991001	1 Set	Mounting in the engine compartment. Drive by pressing Horn button. With flat connections of 6,3 mm, open. Power absorbed: 20W. Electric valve, 24V.

1 Piece

Compressed Air Trumpet

For vehicles with a compressed air brake system.
 Level of acoustic intensity at 2 m distance: 118 dB(A).
 Energy consumption: 35W @ 12V, 50W @ 24V.
 6.3mm flat blade type terminals.
 Robust diecast housing.
 Suitable for tubular fitting Ø 10 mm.
 Pneumatic operation, 2 holes for M10 fixing screws.
 Operating Temperature: -40° C a 90° C (-40°F a 194°F)
 Approval: ECE
 Pressure Range: 6 - 8.3 bar

400 Hz 118 dB(A) 12 V- 24 V-
 11.9 cm (máx.) (4.68") 35 W @ 12 V 50 W @ 24 V ECE

Part No.	Quantity	Description
004206041	1 Piece	Trumpet 12 V, 35 W, 400 Hz - Universal Diameter Measurements: 11.9 cm 9.7 x 9 x 31.1 cm
004206011	1 Piece	Trumpet 24 V, 50 W, 400 Hz - Universal Diameter Measurements: 11.9 cm 9.7 x 9 x 31.1 cm

ACOUSTIC SIGNAL UNITS

COMPRESSED AIR HORNS AND TRUMPET HORNS

Product image / Dimensions

Features



Set of Twin Tone Air Horns



Compressed air horn with ABS plastic body and support in galvanized metal
 Level of acoustic intensity at 2 m distance: 118 dB(A).
 Energy consumption: 240 W.
 Mounting bracket included
 Operating Temperature: -40° C a 90° C (-40°F a 194°F)
 Approval: ECE



Part No.	Quantity	Description
003001651	1 Set	2 Electric Horns - Pneumatic 12 V, 240 W, 780 / 840 Hz - Universal Length of Trumpets: 16.3 cm 21.2 cm Includes compressor, pressure tubes, bifurcated Piece Fastening and Relay 12 V
003001661	1 Set	2 Electric Trumpets - Pneumatic 24 V, 240 W, 780 / 840 Hz - Universal Length of Trumpets: 16.3 mm 21.2 cm Includes compressor, pressure tubes, bifurcated Piece Fastening and Relay 24 V



1 Piece
1 Relay

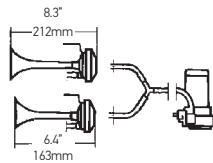

Set of Triple Tone Air Horns



Compressed air horns with ABS plastic body and support in galvanized metal
 Level of acoustic intensity at 2 m distance: 118 dB(A).
 Energy consumption: 240 W.
 Mounting bracket included
 Operating Temperature: -40° C a 90° C (-40°F a 194°F)
 Approval: ECE



Part No.	Quantity	Description
003001671	1 Set	3 Electric Horns - Pneumatic 12 V, 240 W, 780 / 820 / 880 Hz - Universal Length of Trumpets: 14 cm 16.3 cm 21.2 cm Includes compressor, pressure tubes, bifurcated Piece Fastening and Relay 12 V
003001681	1 Set	3 Electric Trumpets - Pneumatic Melodic Sound 12 V, 240 W, 630 / 795 / 840 Hz - Universal Length of Trumpets: 15.8 cm 16.6 cm 21.7 cm Includes compressor, pressure tubes, bifurcated Piece Fastening and Relay 12 V



1 Piece
1 Relay

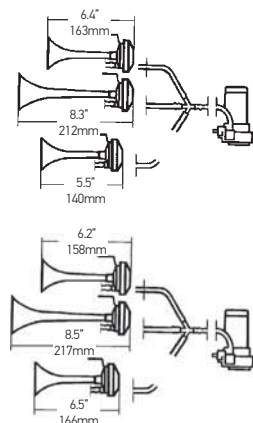

Product image /
Dimensions

Features



Single Tone Compressed Air Horn



Pneumatic operation
Level of acoustic intensity at 2 m distance: 115 dB(A).
Energy consumption: 312 W.
Robust housing.
With flat connections of 6.3 mm, open, blade type
2 holes for M10 fixing screws.
Pressure Range: 0.98 bar

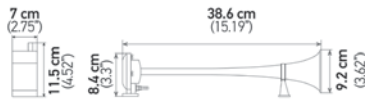

Part No.	Quantity	Description
013410001	1 Set	Air Horn using compressed air - Single tone 12 V, 312 W - Universal Measurements: 9.2 x 8.4 x 38.6 cm Includes compressor, pressure tubes, Fastening and Relay 12 V



Dual Tone Compressed Air Horn



For vehicles with compressed air braking system.
Level of acoustic intensity at 2 m distance: 125 dB(A).
Robust housing.
With flat connections of 6.3 mm, open, blade type
Pressure Range: 6 - 8 bar (87 - 116 PSI)

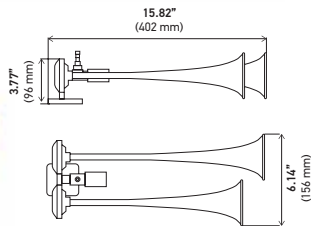

Part No.	Quantity	Description
013410051	1 Piece.	Dual tone compressed air horn - Box 12 V, 41 W - Universal Measurements: 40.2 x 9.6 x 15.6 cm
013410061	1 Piece.	Dual tone compressed air horn - Box 24 V, 77 W - Universal Measurements: 40.2 x 9.6 x 15.6 cm
715991031	1 Set	Replacement solenoid for air trumpet - 12 V
715991041	1 Set	Replacement solenoid for air trumpet - 24 V



Single Tone Air Horn



For vehicles with a compressed air brake system.
Pneumatic operation
Level of acoustic intensity at 2 m distance: 115 dB(A).
Energy consumption: 120 W.
Robust Housing
Suitable for tubular fittings Ø 8 mm. 2 holes for M10 fixing screws.
Pressure Range: 5.88 bar

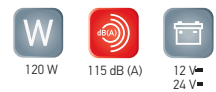

1 Piece

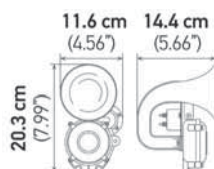

Part No.	Quantity	Description
013410011	1 Piece	Compressed air horn - Single tone 12 - 24 V, 120 W - Universal Measurements: 11.6 x 14.4 x 20.3 cm



BACKUP ALARMS

Safety above all



In some countries, regulations require the installation of a reverse alarm when motor vehicles have obstructed eyesight to the rear. The vehicle must have an audible reverse alarm above the surrounding noise level. Unless, the vehicle is backed up when an observer indicates that it is safe to do so.

All bidirectional machines, such as rollers, compactors, front loaders, bulldozers and similar equipment, must be equipped with a reverse alarm, which will be differentiated from the surrounding noise level and which will be operated as necessary when the machine is in motion. The reverse alarm has to be maintained in operating conditions. Many of the regulations require a sound level greater than 90 dB.



ELECTRICS

BACKUP ALARMS

Product image / Dimensions	Features
----------------------------	----------



Backup Alarm



Black plastic housing.
 With integrated bracket for universal mounting.
 The level of sound intensity is generated by the electronics of solid bodies.
 Level of acoustic intensity at 2 m distance: 110 dB (A).
 Multivoltage: 9 V - 48 V
 Rated Continuous Current: 0.1 - 0.6 A
 Operating temperature: -40 °C to +85 °C.
 Protection class: IP67 (Resistant to water immersions)
 Approval: ECE R10 / 107 dB



Part No.	Quantity	Description
009148142	1 Piece	Backup Alarm - Plastic blister Multivolt: 9 - 48 V - Universal Protection Class: IP67K Measurements: 10.1 x 3.9 x 6.5 cm
009148141	1 Piece	Backup Alarm - Box Multivolt: 9 - 48 V - Universal Protection Class: IP67K Measurements: 10.1 x 3.9 x 6.5 cm
009148161	1 Piece	Backup Alarm - Box - with grounding strap NEW Multivolt: 9 - 48 V - Universal Protection Class: IP67K Measurements: 10.1 x 3.9 x 6.5 cm
009148221	1 Piece	Backup Alarm - Box - with grounding strap, NEW SAE J994 Type C, 102 dB (A) Multivolt: 9 - 48 V - Universal Protection Class: IP67K Measurements: 10.1 x 3.9 x 6.5 cm



1 Piece



1 Piece

Ask your sales representative about product availability in your region

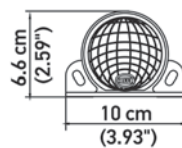

Product image /
 Dimensions

Features



Reverse Alarm



Black steel housing.
 With integrated bracket for universal mounting.
 The level of sound intensity is generated by the solid body electronics.
 Approved against electromagnetic tolerance and according to SAE.
 With protection against reverse polarity and voltage points.
 Operating temperature: -40 ° C to +85 ° C.
 60 signals per minute.
 Protection class: IP5K9K, CE, SAE J994, E11.



Part No.	Quantity	Description
996139001	1 Piece	Reverse Alarm With automatic adaptation to the environment with variable acoustic level. The solid body electronics is automatically set to 5 dB (A) above the ambient acoustic level. With connection cable of 16 cm long Voltage: 12V - 24V. Current consumption: 0.59A - 0.71A. Acoustic level: 87-112 dB (A) (1.2 m). Frequency: 1200 Hz ± 20%.
996139101	1 Piece	Reverse Alarm. With connection cable 16 cm long Voltage: 12V - 36V. Current consumption: 0.4A. Acoustic level: 107 dB (A) (1.2 m). Frequency: 1300 Hz ± 20%.
996139111	1 Piece	Reverse Alarm. With connection cable 16 cm long Voltage: 12V - 36V. Current consumption: 0.4A. Acoustic level: 112 dB (A) (1.2 m). Frequency: 1250 Hz ± 20%.



1 Piece

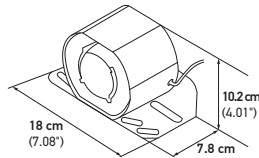

Reverse Alarm



Black plastic housing.
 With integrated bracket for universal mounting.
 The level of sound intensity is generated by the electronic of solid bodies.
 Approved against electromagnetic tolerance and according to SAE.
 With protection against reverse polarity and voltage points.
 Operating temperature: -40 ° C to +85 ° C.
 Frequency: 60 signals per minute; 1250 Hz ± 20% .



Part No.	Quantity	Description
009148001	1 Piece	Reverse Alarm. Voltage: 12V - 24V. Current consumption: 0.1A - 0.2A. Acoustic level: 90 dB (A) (1.2 m), with integrated AMP plug.
009148011	1 Piece	Reverse Alarm. Voltage: 12V - 24V. Current consumption: 0.3A - 0.4A. Acoustic level: 97 dB (A) (1.2 m), with integrated AMP plug.
009148021	1 Piece	Reverse Alarm. Voltage: 12V - 24V. Current consumption: 0.6A - 0.7A. Acoustic level: 107 dB (A) (1.2 m), with integrated AMP plug.



1 Piece

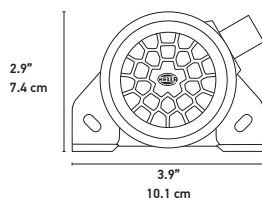

ELECTRICS

HORNS DISPLAY

Product image /
Dimensions

Features

Horns display



Includes power source, switches and connections

Includes the following products:

009148141 - Backup alarm

011225831 - TC16 horn set

012010851 - TE16 horn set

011225871 - S92 horn set

011225802 - S77 horn set









012588011 - Motorcycle horn set

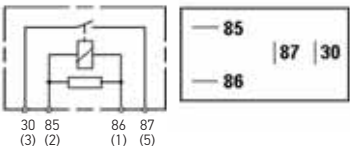

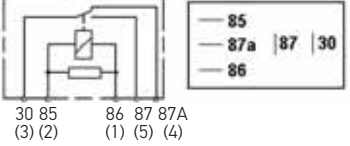

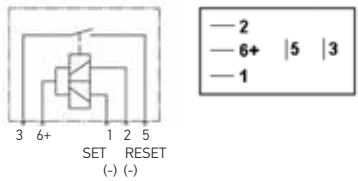

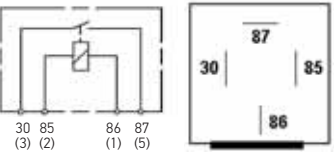

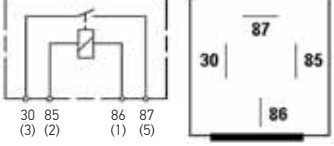
Part Number	Quantity	Description
358117521	1 Piece.	Horn display

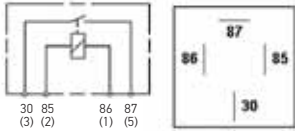
The exhibitor and its contents may change without notice.

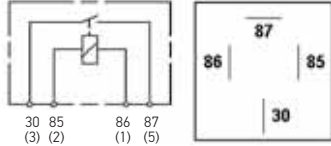
Warning: The high level of sound produced by the speakers and / or bugles may cause discomfort and / or damage to the ears, take precautions

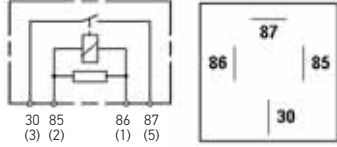

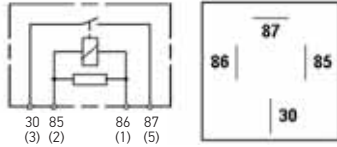

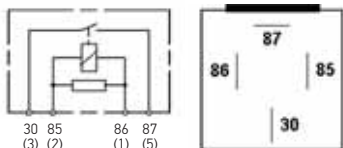



Available
Now!

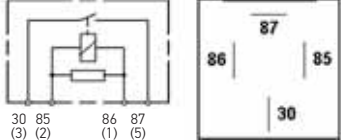

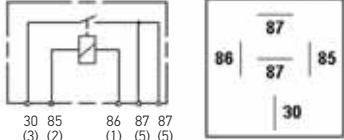

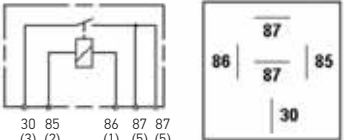

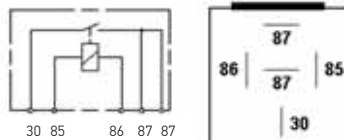

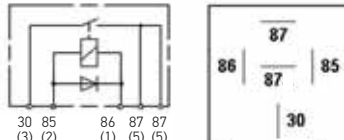
Product image / Dimensions	Features	Part Number	Technical Specifications						
<p>Micro Relay ISO</p> 	<ul style="list-style-type: none"> • 12 V • SPST / Form A • 35 Amp • Resistor Coil Suppression 	<p>933766801</p> <p>Technical Data</p>	<p>Minimum Order Quantity: 1</p> <table border="1"> <tr><td>Rated Voltage</td><td>12 V</td></tr> <tr><td>Rated Current</td><td>35A at 85°C</td></tr> <tr><td>Contact form</td><td>1 Form A / SPST N/O</td></tr> </table>	Rated Voltage	12 V	Rated Current	35A at 85°C	Contact form	1 Form A / SPST N/O
Rated Voltage	12 V								
Rated Current	35A at 85°C								
Contact form	1 Form A / SPST N/O								
<p>Micro Relay ISO</p> 	<ul style="list-style-type: none"> • 12 V • SPDT / Form C • 35 Amp • Resistor Coil Suppression 	<p>965453801</p> <p>Technical Data</p>	<p>Minimum Order Quantity: 1</p> <table border="1"> <tr><td>Rated Voltage</td><td>12 V</td></tr> <tr><td>Rated Current</td><td>N/O 35A N/C 20A at 85°C</td></tr> <tr><td>Contact form</td><td>1 Form C / SPDT</td></tr> </table>	Rated Voltage	12 V	Rated Current	N/O 35A N/C 20A at 85°C	Contact form	1 Form C / SPDT
Rated Voltage	12 V								
Rated Current	N/O 35A N/C 20A at 85°C								
Contact form	1 Form C / SPDT								
<p>Micro Relay ISO</p> 	<ul style="list-style-type: none"> • 12 V • SPST / Form A • 30 Amp • Bistable / Magnetic Latching 	<p>933364027</p> <p>Technical Data</p>	<p>Minimum Order Quantity: 1</p> <table border="1"> <tr><td>Rated Voltage</td><td>12 V</td></tr> <tr><td>Rated Current</td><td>30A at 85°C</td></tr> <tr><td>Contact form</td><td>1 Form A / SPST N/O</td></tr> </table>	Rated Voltage	12 V	Rated Current	30A at 85°C	Contact form	1 Form A / SPST N/O
Rated Voltage	12 V								
Rated Current	30A at 85°C								
Contact form	1 Form A / SPST N/O								
<p>Mini Relay ISO</p> 	<ul style="list-style-type: none"> • 12 V • SPST / Form A • Mounting Bracket • 30 Amp • Alternate Footprint 	<p>965400071</p> <p>965400077</p> <p>Technical Data</p>	<p>Minimum Order Quantity: 1</p> <p>Pack - Minimum Order Quantity: 40</p> <table border="1"> <tr><td>Voltaje Nominal</td><td>12 V</td></tr> <tr><td>Rated Current</td><td>30A at 85°C</td></tr> <tr><td>Contact form</td><td>1 Form A / SPST N/O</td></tr> </table>	Voltaje Nominal	12 V	Rated Current	30A at 85°C	Contact form	1 Form A / SPST N/O
Voltaje Nominal	12 V								
Rated Current	30A at 85°C								
Contact form	1 Form A / SPST N/O								
<p>Mini Relay ISO</p> 	<ul style="list-style-type: none"> • 24 V • SPST / Form A • Mounting Bracket • 30 Amp • Alternate Footprint 	<p>965400101</p> <p>Technical Data</p>	<p>Minimum Order Quantity: 1</p> <table border="1"> <tr><td>Voltaje Nominal</td><td>24 V</td></tr> <tr><td>Rated Current</td><td>30A at 85°C</td></tr> <tr><td>Contact form</td><td>1 Form A / SPST N/O</td></tr> </table>	Voltaje Nominal	24 V	Rated Current	30A at 85°C	Contact form	1 Form A / SPST N/O
Voltaje Nominal	24 V								
Rated Current	30A at 85°C								
Contact form	1 Form A / SPST N/O								

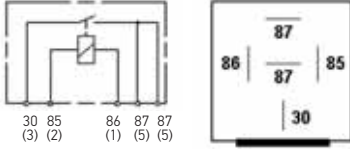
Product image / Dimensions	Features	Part Number	Technical Specifications
Mini Relay ISO 	<ul style="list-style-type: none"> • 12 V • SPST / Form A • 40 Amp • Dust Cover 	933332451	Minimum Order Quantity: 1
		933332457	Pack - Minimum Order Quantity: 40
		Technical Data	
		Voltaje Nominal	12 V
		Rated Current	40A at 85°C
		Contact form	1 Form A / SPST N/O
Mini Relay ISO 	<ul style="list-style-type: none"> • 24 V • SPST / Form A • 20 Amp • Dust Covers 	933332461	Minimum Order Quantity: 1
		Technical Data	
		Voltaje Nominal	24 V
		Rated Current	20A at 85°C
		Contact form	1 Form A / SPST N/O
Mini Relay ISO 	<ul style="list-style-type: none"> • 12 V • SPST / Form A • Dust Cover • 40 Amp • Resistor Coil Suppression 	933332541	Minimum Order Quantity: 1
		Technical Data	
		Voltaje Nominal	12 V
		Rated Current	40A at 85°C
		Contact form	1 Form A / SPST N/O
Mini Relay ISO 	<ul style="list-style-type: none"> • 24 V • SPST / Form A • Dust Covers • 20 Amp • Resistor Coil Suppression 	007957001	Minimum Order Quantity: 1
		007957007	Pack - Minimum Order Quantity: 200
		Technical Data	
		Voltaje Nominal	24 V
		Rated Current	20A at 85°C
		Contact form	1 Form A / SPST N/O
Mini Relay ISO 	<ul style="list-style-type: none"> • 12 V • SPST / Form A • Mounting Bracket • 40 Amp • Resistor Coil Suppression 	007791021	Minimum Order Quantity: 1
		007791027	Pack - Minimum Order Quantity: 200
		Technical Data	
		Voltaje Nominal	12 V
		Rated Current	40A at 85°C
		Contact form	1 Form A / SPST N/O

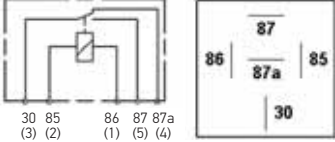
ELECTRICS

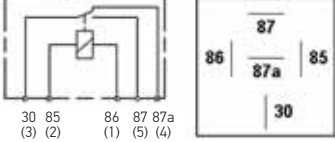

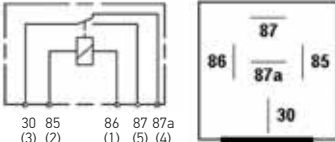

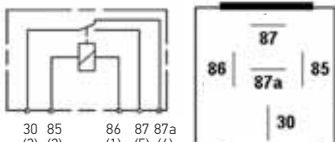



RELAYS

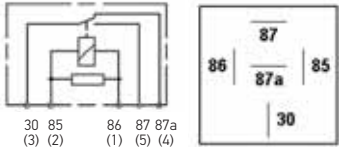

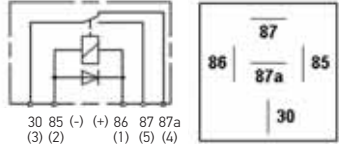

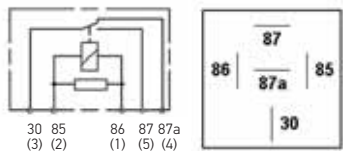

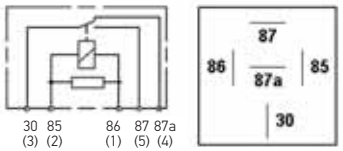

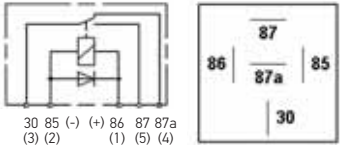
Product image / Dimensions	Features	Part Number	Technical Specifications						
<p>Mini Relay ISO</p> 	<ul style="list-style-type: none"> • 24 V • SPST / Form A • Mounting Bracket • 20 Amp • Resistor Coil Suppression 	<p>007957011</p> <p>007957017</p> <p>Technical Data</p>	<p>Minimum Order Quantity: 1</p> <p>Pack - Minimum Order Quantity: 200</p> <table border="1"> <tr> <td>Voltaje Nominal</td> <td>24 V</td> </tr> <tr> <td>Rated Current</td> <td>20A at 85°C</td> </tr> <tr> <td>Contact form</td> <td>1 Form A / SPST N/O</td> </tr> </table>	Voltaje Nominal	24 V	Rated Current	20A at 85°C	Contact form	1 Form A / SPST N/O
Voltaje Nominal	24 V								
Rated Current	20A at 85°C								
Contact form	1 Form A / SPST N/O								
<p>Mini Relay ISO</p> 	<ul style="list-style-type: none"> • 12 V • SPST / Form A • Dust Cover • 40 Amp • Dual Output (2x Terminal 87) 	<p>933791161</p> <p>933791167</p> <p>Technical Data</p>	<p>Minimum Order Quantity: 1</p> <p>Pack - Minimum Order Quantity: 40</p> <table border="1"> <tr> <td>Voltaje Nominal</td> <td>12 V</td> </tr> <tr> <td>Rated Current</td> <td>40A at 85°C</td> </tr> <tr> <td>Contact form</td> <td>1 Form A / SPST N/O (2 x Terminal 87)</td> </tr> </table>	Voltaje Nominal	12 V	Rated Current	40A at 85°C	Contact form	1 Form A / SPST N/O (2 x Terminal 87)
Voltaje Nominal	12 V								
Rated Current	40A at 85°C								
Contact form	1 Form A / SPST N/O (2 x Terminal 87)								
<p>Mini Relay ISO</p> 	<ul style="list-style-type: none"> • 24 V • SPST / Form A • Dust Cover • 20 Amp • Dual Output (2x Terminal 87) 	<p>933791141</p> <p>Technical Data</p>	<p>Minimum Order Quantity: 1</p> <table border="1"> <tr> <td>Voltaje Nominal</td> <td>24 V</td> </tr> <tr> <td>Rated Current</td> <td>20A at 85°C</td> </tr> <tr> <td>Contact form</td> <td>1 Form A / SPST N/O (2x Terminal 87)</td> </tr> </table>	Voltaje Nominal	24 V	Rated Current	20A at 85°C	Contact form	1 Form A / SPST N/O (2x Terminal 87)
Voltaje Nominal	24 V								
Rated Current	20A at 85°C								
Contact form	1 Form A / SPST N/O (2x Terminal 87)								
<p>Mini Relay ISO</p> 	<ul style="list-style-type: none"> • 12 V • SPST / Form A • Mounting Bracket • 40 Amp • Dual Output (2x Terminal 87) 	<p>933791121</p> <p>933791127</p> <p>Technical Data</p>	<p>Minimum Order Quantity: 1</p> <p>Pack - Minimum Order Quantity: 40</p> <table border="1"> <tr> <td>Voltaje Nominal</td> <td>12 V</td> </tr> <tr> <td>Rated Current</td> <td>40A at 85°C</td> </tr> <tr> <td>Contact form</td> <td>1 Form A / SPST N/O (2 x Terminal 87)</td> </tr> </table>	Voltaje Nominal	12 V	Rated Current	40A at 85°C	Contact form	1 Form A / SPST N/O (2 x Terminal 87)
Voltaje Nominal	12 V								
Rated Current	40A at 85°C								
Contact form	1 Form A / SPST N/O (2 x Terminal 87)								
<p>Mini Relay ISO</p> 	<ul style="list-style-type: none"> • 12 V • SPST / Form A • Mounting Bracket • 40 Amp • Dual Output (2x Terminal 87) • Diode Coil Suppression 	<p>933791151</p> <p>Technical Data</p>	<p>Minimum Order Quantity: 1</p> <table border="1"> <tr> <td>Voltaje Nominal</td> <td>12 V</td> </tr> <tr> <td>Rated Current</td> <td>40A at 85°C</td> </tr> <tr> <td>Contact form</td> <td>1 Form A / SPST N/O (2x Terminal 87)</td> </tr> </table>	Voltaje Nominal	12 V	Rated Current	40A at 85°C	Contact form	1 Form A / SPST N/O (2x Terminal 87)
Voltaje Nominal	12 V								
Rated Current	40A at 85°C								
Contact form	1 Form A / SPST N/O (2x Terminal 87)								

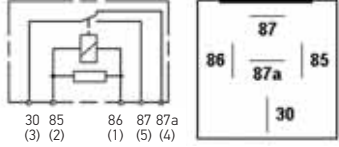
Product image / Dimensions	Features	Part Number	Technical Specifications				
Mini Relay ISO 	<ul style="list-style-type: none"> • 24 V • SPST / Form A • Mounting Bracket • 20 Amp • Dual output (2 x Terminal 87) 	933791131	Minimum Order Quantity: 1				
		Technical Data	<table border="1"> <tr> <td>Voltaje Nominal</td> <td>24 V</td> </tr> <tr> <td>Rated Current</td> <td>20A at 85°C</td> </tr> <tr> <td>Contact form</td> <td>1 Form A / SPST N/O (2 x Terminal 87)</td> </tr> </table>	Voltaje Nominal	24 V	Rated Current	20A at 85°C
Voltaje Nominal	24 V						
Rated Current	20A at 85°C						
Contact form	1 Form A / SPST N/O (2 x Terminal 87)						
Mini Relay ISO 	<ul style="list-style-type: none"> • 12 V • SPDT / Form C • 40 Amp • Dust cover 	933332401	Minimum Order Quantity: 1				
		933332407	Pack - Minimum Order Quantity: 40				
Technical Data	<table border="1"> <tr> <td>Voltaje Nominal</td> <td>12 V</td> </tr> <tr> <td>Rated Current</td> <td>N/O 40A N/C 20A at 85°C</td> </tr> <tr> <td>Contact form</td> <td>1 Form C / SPDT</td> </tr> </table>	Voltaje Nominal	12 V	Rated Current	N/O 40A N/C 20A at 85°C	Contact form	1 Form C / SPDT
Voltaje Nominal	12 V						
Rated Current	N/O 40A N/C 20A at 85°C						
Contact form	1 Form C / SPDT						
Mini Relay ISO 	<ul style="list-style-type: none"> • 24 V • SPDT / Form C • 20 Amp • Dust cover 	933332421	Minimum Order Quantity: 1				
		933332427	Minimum Order Quantity: 40				
Technical Data	<table border="1"> <tr> <td>Voltaje Nominal</td> <td>24 V</td> </tr> <tr> <td>Rated Current</td> <td>N/O 20A N/C 10A at 85°C</td> </tr> <tr> <td>Contact form</td> <td>1 Form C / SPDT</td> </tr> </table>	Voltaje Nominal	24 V	Rated Current	N/O 20A N/C 10A at 85°C	Contact form	1 Form C / SPDT
Voltaje Nominal	24 V						
Rated Current	N/O 20A N/C 10A at 85°C						
Contact form	1 Form C / SPDT						
Mini Relay ISO 	<ul style="list-style-type: none"> • 12 V • SPDT / Form C • 40 Amp • Mounting Bracket 	933332361	Minimum Order Quantity: 1				
		Technical Data	<table border="1"> <tr> <td>Voltaje Nominal</td> <td>12 V</td> </tr> <tr> <td>Rated Current</td> <td>N/O 40A N/C 20A at 85°C</td> </tr> <tr> <td>Contact form</td> <td>1 Form C / SPDT</td> </tr> </table>	Voltaje Nominal	12 V	Rated Current	N/O 40A N/C 20A at 85°C
Voltaje Nominal	12 V						
Rated Current	N/O 40A N/C 20A at 85°C						
Contact form	1 Form C / SPDT						
Mini Relay ISO 	<ul style="list-style-type: none"> • 24 V • SPDT / Form C • 20 Amp • Mounting Bracket 	933332411	Minimum Order Quantity: 1				
		933332417	Pack - Minimum Order Quantity: 40				
Technical Data	<table border="1"> <tr> <td>Voltaje Nominal</td> <td>24 V</td> </tr> <tr> <td>Rated Current</td> <td>N/O 20A N/C 10A at 85°C</td> </tr> <tr> <td>Contact form</td> <td>1 Form C / SPDT</td> </tr> </table>	Voltaje Nominal	24 V	Rated Current	N/O 20A N/C 10A at 85°C	Contact form	1 Form C / SPDT
Voltaje Nominal	24 V						
Rated Current	N/O 20A N/C 10A at 85°C						
Contact form	1 Form C / SPDT						

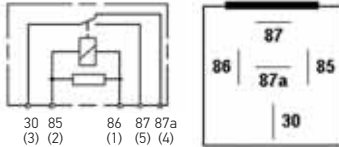
ELECTRICS

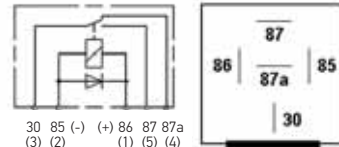

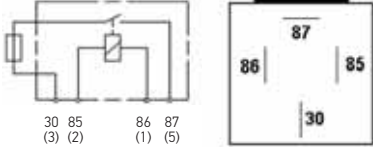

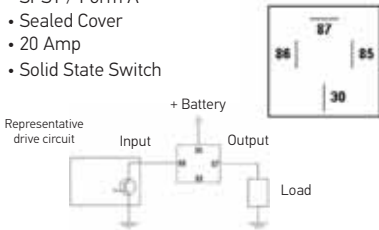



RELAYS

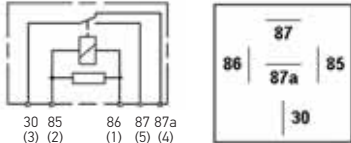

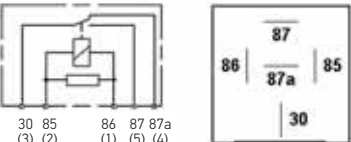

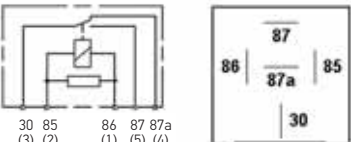

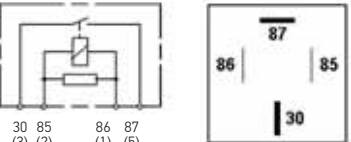
Product image / Dimensions	Features	Part Number	Technical Specifications				
Mini Relay ISO 	<ul style="list-style-type: none"> • 12 V • SPDT / Form C • Dust cover • 40 Amp • Resistor Coil Suppression 	933332641	Minimum Order Quantity: 1				
		Technical Data <table border="1"> <tr> <td>Voltaje Nominal</td> <td>12 V</td> </tr> <tr> <td>Rated Current</td> <td>N/O 40A N/C 20A at 85°C</td> </tr> <tr> <td>Contact form</td> <td>1 Form C / SPDT</td> </tr> </table>		Voltaje Nominal	12 V	Rated Current	N/O 40A N/C 20A at 85°C
Voltaje Nominal	12 V						
Rated Current	N/O 40A N/C 20A at 85°C						
Contact form	1 Form C / SPDT						
Mini Relay ISO 	<ul style="list-style-type: none"> • 12 V • SPDT / Form C • Dust cover • 40 Amp • Diode Coil Suppression • Dust Cover 	007794041	Minimum Order Quantity: 1				
		007794047	Pack - Minimum Order Quantity: 200				
Technical Data <table border="1"> <tr> <td>Voltaje Nominal</td> <td>12 V</td> </tr> <tr> <td>Rated Current</td> <td>N/O 40A N/C 20A at 85°C</td> </tr> <tr> <td>Contact form</td> <td>1 Form C / SPDT</td> </tr> </table>		Voltaje Nominal	12 V	Rated Current	N/O 40A N/C 20A at 85°C	Contact form	1 Form C / SPDT
Voltaje Nominal	12 V						
Rated Current	N/O 40A N/C 20A at 85°C						
Contact form	1 Form C / SPDT						
Mini Relay ISO 	<ul style="list-style-type: none"> • 12 V • SPDT / Form C • Sealed cover • 40 Amp • Resistor Coil Suppression 	931680901	Minimum Order Quantity: 1				
		931680017	Pack - Minimum Order Quantity: 360				
Technical Data <table border="1"> <tr> <td>Voltaje Nominal</td> <td>12 V</td> </tr> <tr> <td>Rated Current</td> <td>N/O 40A N/C 20A at 85°C</td> </tr> <tr> <td>Contact form</td> <td>1 Form C / SPDT</td> </tr> </table>		Voltaje Nominal	12 V	Rated Current	N/O 40A N/C 20A at 85°C	Contact form	1 Form C / SPDT
Voltaje Nominal	12 V						
Rated Current	N/O 40A N/C 20A at 85°C						
Contact form	1 Form C / SPDT						
Mini Relay ISO 	<ul style="list-style-type: none"> • 24 V • SPDT / Form C • Dust cover • 20 Amp • Resistor Coil Suppression 	933332611	Minimum Order Quantity: 1				
		Technical Data <table border="1"> <tr> <td>Voltaje Nominal</td> <td>24 V</td> </tr> <tr> <td>Rated Current</td> <td>N/O 20A N/C 10A at 85°C</td> </tr> <tr> <td>Contact form</td> <td>1 Form C / SPDT</td> </tr> </table>		Voltaje Nominal	24 V	Rated Current	N/O 20A N/C 10A at 85°C
Voltaje Nominal	24 V						
Rated Current	N/O 20A N/C 10A at 85°C						
Contact form	1 Form C / SPDT						
Mini Relay ISO 	<ul style="list-style-type: none"> • 24 V • SPDT / Form C • Dust cover • 20 Amp • Diode Coil Suppression 	933332441	Minimum Order Quantity: 1				
		933332447	Minimum Order Quantity: 40				
Technical Data <table border="1"> <tr> <td>Voltaje Nominal</td> <td>24 V</td> </tr> <tr> <td>Rated Current</td> <td>N/O 20A N/C 10A at 85°C</td> </tr> <tr> <td>Contact form</td> <td>1 Form C / SPDT</td> </tr> </table>		Voltaje Nominal	24 V	Rated Current	N/O 20A N/C 10A at 85°C	Contact form	1 Form C / SPDT
Voltaje Nominal	24 V						
Rated Current	N/O 20A N/C 10A at 85°C						
Contact form	1 Form C / SPDT						

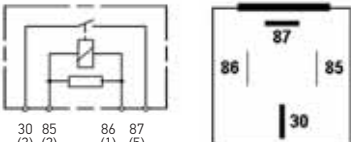

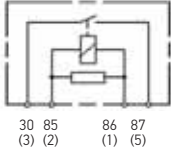
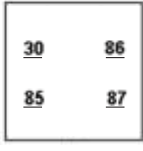

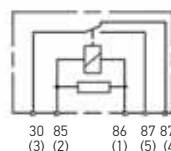
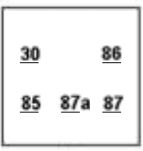
Product image / Dimensions	Features	Part Number	Technical Specifications					
Mini Relay ISO 	<ul style="list-style-type: none"> • 12 V • SPDT / Form C • Mounting Bracket • 40 Amp • Resistor Coil Suppression 	933332661	Minimum Order Quantity: 1					
		Technical Data	<table border="1"> <tr> <td>Voltaje Nominal</td> <td>12 V</td> </tr> <tr> <td>Rated Current</td> <td>N/O 40A N/C 20A at 85°C</td> </tr> <tr> <td>Contact form</td> <td>1 Form C / SPDT</td> </tr> </table>		Voltaje Nominal	12 V	Rated Current	N/O 40A N/C 20A at 85°C
Voltaje Nominal	12 V							
Rated Current	N/O 40A N/C 20A at 85°C							
Contact form	1 Form C / SPDT							
Mini Relay ISO 	<ul style="list-style-type: none"> • 24 V • SPDT / Form C • Mounting Bracket • 20 Amp • Resistor Coil Suppression 	933332701	Minimum Order Quantity: 1					
		Technical Data	<table border="1"> <tr> <td>Voltaje Nominal</td> <td>24 V</td> </tr> <tr> <td>Rated Current</td> <td>N/O 20A N/C 10A at 85°C</td> </tr> <tr> <td>Contact form</td> <td>1 Form C / SPDT</td> </tr> </table>		Voltaje Nominal	24 V	Rated Current	N/O 20A N/C 10A at 85°C
Voltaje Nominal	24 V							
Rated Current	N/O 20A N/C 10A at 85°C							
Contact form	1 Form C / SPDT							
Mini Relay ISO 	<ul style="list-style-type: none"> • 24 V • SPDT / Form C • Mounting Bracket • 20 Amp • Diode Coil Suppression 	933332681	Minimum Order Quantity: 1					
		Technical Data	<table border="1"> <tr> <td>Voltaje Nominal</td> <td>24 V</td> </tr> <tr> <td>Rated Current</td> <td>N/O 20A N/C 10A at 85°C</td> </tr> <tr> <td>Contact form</td> <td>1 Form C / SPDT</td> </tr> </table>		Voltaje Nominal	24 V	Rated Current	N/O 20A N/C 10A at 85°C
Voltaje Nominal	24 V							
Rated Current	N/O 20A N/C 10A at 85°C							
Contact form	1 Form C / SPDT							
Mini Relay ISO with built-in 25A fuse 	<ul style="list-style-type: none"> • 12 V • SPST / Form A • Mounting Bracket • 30 Amp • With Built-in 25Amp Fuse 	933332801	Minimum Order Quantity: 1					
		Technical Data	<table border="1"> <tr> <td>Voltaje Nominal</td> <td>12 V</td> </tr> <tr> <td>Rated Current</td> <td>30A at 23°C</td> </tr> <tr> <td>Contact form</td> <td>1 Form A / SPST N/O</td> </tr> </table>		Voltaje Nominal	12 V	Rated Current	30A at 23°C
Voltaje Nominal	12 V							
Rated Current	30A at 23°C							
Contact form	1 Form A / SPST N/O							
Solid State Mini Relay ISO 	<ul style="list-style-type: none"> • 12 V • SPST / Form A • Sealed Cover • 20 Amp • Solid State Switch 	931774031	Minimum Order Quantity: 1					
		931774037	Pack - Minimum Order Quantity: 189					
Technical Data	<table border="1"> <tr> <td>Voltaje Nominal</td> <td>12 V</td> </tr> <tr> <td>Rated Current</td> <td>20A at 85°C</td> </tr> <tr> <td>Contact form</td> <td>1 Form A / SPST N/O</td> </tr> </table>		Voltaje Nominal	12 V	Rated Current	20A at 85°C	Contact form	1 Form A / SPST N/O
Voltaje Nominal	12 V							
Rated Current	20A at 85°C							
Contact form	1 Form A / SPST N/O							

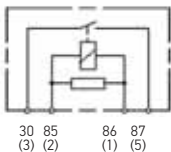
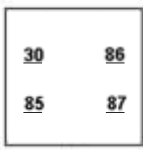
ELECTRICS

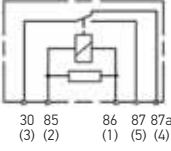
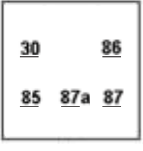
RELAYS

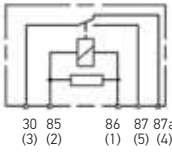
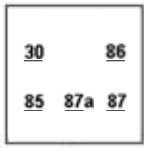
Product image / Dimensions	Features	Part Number	Technical Specifications						
<p>Mini Relay ISO</p> 	<ul style="list-style-type: none"> • 12 V • SPDT / Form C • 40 Amp • Resistor Coil Suppression • Weatherproof Cover 	<p>007794931</p> <p>007794327</p> <p>Technical Data</p> <table border="1"> <tr><td>Voltaje Nominal</td><td>12 V</td></tr> <tr><td>Rated Current</td><td>N/O 40A N/C 20A at 85°C</td></tr> <tr><td>Contact form</td><td>1 Form C / SPDT</td></tr> </table> <p>Relay universal mounting bracket universal</p> <p>H84975001</p> <p>960975001</p>	Voltaje Nominal	12 V	Rated Current	N/O 40A N/C 20A at 85°C	Contact form	1 Form C / SPDT	<p>Minimum Order Quantity: 1</p> <p>Pack - Minimum Order Quantity: 150</p>
Voltaje Nominal	12 V								
Rated Current	N/O 40A N/C 20A at 85°C								
Contact form	1 Form C / SPDT								
<p>Mini Relay ISO</p> 	<ul style="list-style-type: none"> • 12 V • SPDT / Form C • Mounting Bracket • 40 Amp • Resistor Coil Suppression • Weatherproof Cover 	<p>007794911 (007794301)</p> <p>007794307</p> <p>Technical Data</p> <table border="1"> <tr><td>Voltaje Nominal</td><td>12 V</td></tr> <tr><td>Rated Current</td><td>N/O 40A N/C 20A at 85°C</td></tr> <tr><td>Contact form</td><td>1 Form C / SPDT</td></tr> </table>	Voltaje Nominal	12 V	Rated Current	N/O 40A N/C 20A at 85°C	Contact form	1 Form C / SPDT	<p>Minimum Order Quantity: 1</p> <p>Pack - Minimum Order Quantity: 150</p>
Voltaje Nominal	12 V								
Rated Current	N/O 40A N/C 20A at 85°C								
Contact form	1 Form C / SPDT								
<p>Mini Relay ISO</p> 	<ul style="list-style-type: none"> • 24 V • SPDT / Form C • Mounting Bracket • 20 Amp • Resistor Coil Suppression • Weatherproof Cover 	<p>933332201</p> <p>933332207</p> <p>Technical Data</p> <table border="1"> <tr><td>Voltaje Nominal</td><td>24 V</td></tr> <tr><td>Rated Current</td><td>N/O 20A N/C 10A at 85°C</td></tr> <tr><td>Contact form</td><td>1 Form C / SPDT</td></tr> </table>	Voltaje Nominal	24 V	Rated Current	N/O 20A N/C 10A at 85°C	Contact form	1 Form C / SPDT	<p>Minimum Order Quantity: 1</p> <p>Pack - Minimum Order Quantity: 80</p>
Voltaje Nominal	24 V								
Rated Current	N/O 20A N/C 10A at 85°C								
Contact form	1 Form C / SPDT								
<p>Mini ISO Power Relay</p> 	<ul style="list-style-type: none"> • 12 V • SPST / Form A • Dust cover • 50 Amp • Resistor Coil Suppression 	<p>933332531</p> <p>Technical Data</p> <table border="1"> <tr><td>Voltaje Nominal</td><td>12 V</td></tr> <tr><td>Rated Current</td><td>50A at 85°C</td></tr> <tr><td>Contact form</td><td>1 Form A / SPST N/O</td></tr> </table>	Voltaje Nominal	12 V	Rated Current	50A at 85°C	Contact form	1 Form A / SPST N/O	<p>Minimum Order Quantity: 1</p>
Voltaje Nominal	12 V								
Rated Current	50A at 85°C								
Contact form	1 Form A / SPST N/O								
<p>Mini ISO Power Relay</p> 	<ul style="list-style-type: none"> • 12 V • SPST / Form A • Mounting Bracket • 50 Amp • Resistor Coil Suppression 	<p>933332521</p> <p>Technical Data</p> <table border="1"> <tr><td>Voltaje Nominal</td><td>12 V</td></tr> <tr><td>Rated Current</td><td>50A at 85°C</td></tr> <tr><td>Contact form</td><td>1 Form A / SPST N/O</td></tr> </table>	Voltaje Nominal	12 V	Rated Current	50A at 85°C	Contact form	1 Form A / SPST N/O	<p>Minimum Order Quantity: 1</p>
Voltaje Nominal	12 V								
Rated Current	50A at 85°C								
Contact form	1 Form A / SPST N/O								

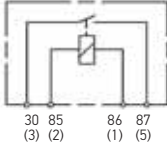
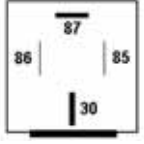
Product image / Dimensions	Features	Part Number	Technical Specifications
Micro Relay 280 	<ul style="list-style-type: none"> • 12 V • SPST / Form A • 30 Amp • Resistor Coil Suppression • Dust Cover  	933332571	Minimum Order Quantity: 1 Technical Data Voltaje Nominal: 12 V Rated Current: 30A at 125°C Contact form: 1 Form A / SPST N/O
Micro Relay 280 	<ul style="list-style-type: none"> • 12 V • SPDT / Form C • 30 Amp • Resistor Coil Suppression • Dust Cover  	933332581	Minimum Order Quantity: 1 Technical Data Voltaje Nominal: 12 V Rated Current: N/O 30A N/C 20A at 125°C Contact form: 1 Form C / SPDT
Micro Relay 280 	<ul style="list-style-type: none"> • 12 V • SPST / Form A • 35 Amp • Resistor Coil Suppression • Dust Cover  	933332591	Minimum Order Quantity: 1 Technical Data Voltaje Nominal: 12 V Rated Current: 35A at 125°C Contact form: 1 Form A / SPST N/O
Micro Relay 280 	<ul style="list-style-type: none"> • 12 V • SPDT / Form C • 35 Amp • Resistor Coil Suppression • Dust Cover  	933332601	Minimum Order Quantity: 1 Technical Data Voltaje Nominal: 12 V Rated Current: N/O 35A N/C 20A at 125°C Contact form: 1 Form C / SPDT

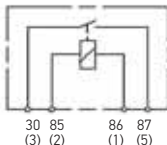
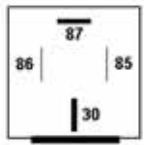
Product image / Dimensions	Features	Part Number	Technical Specifications
<p>Mini Relay 280</p> 	<ul style="list-style-type: none"> • 12 V • SPDT / Form C • Mounting Bracket • 35 Amp • Weatherproof Cover • Resistor Coil Suppression  	<p>With mounting bracket</p> <p>931410082 (H41410081)</p> <p>931410087</p> <p>Without mounting bracket</p> <p>931410901 (H41410051)</p> <p>931410057</p> <p>Technical Data</p>	<p>Minimum Order Quantity: 1</p> <p>Pack - Minimum Order Quantity: 80</p> <p>Minimum Order Quantity: 1</p> <p>Pack - Minimum Order Quantity: 80</p> <p>Voltaje Nominal: 12 V</p> <p>Rated Current: N/O 35A N/C 20A at 85°C</p> <p>Contact form: 1 Form C / SPDT</p> <p>Relay universal mounting bracket universal</p> <p>358112031 Quantity: 10 pieces</p> <p>931489901 Quantity: 100 pieces</p>
<p>Mini Relay ISO Heavy Duty</p> 	<ul style="list-style-type: none"> • 12 V • SPST / Form A • 60 Amp • Mounting Bracket  	<p>003437081</p> <p>003437087</p> <p>Technical Data</p>	<p>Minimum Order Quantity: 1</p> <p>Pack - Minimum Order Quantity: 120</p> <p>Voltaje Nominal: 12 V</p> <p>Rated Current: 60A at 85°C</p> <p>Contact form: 1 Form A / SPST N/O</p>
<p>Mini Relay ISO Heavy Duty</p> 	<ul style="list-style-type: none"> • 24 V • SPST / Form A • 60 Amp • Mounting Bracket  	<p>003437092 (H41437091)</p> <p>003437097</p> <p>Technical Data</p>	<p>Minimum Order Quantity: 1</p> <p>Pack - Minimum Order Quantity: 120</p> <p>Voltaje Nominal: 24 V</p> <p>Rated Current: 60A at 85°C</p> <p>Contact form: 1 Form A / SPST N/O</p>

ELECTRICS

FLASHERS

Product image / Dimensions	Features	Part Number	Technical Specifications
----------------------------	----------	-------------	--------------------------

Flasher 2 Terminals

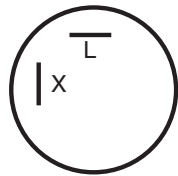

Common Pin Designations

Terminal	Description
49/X	Flashing input (+)
49a/L	Flasher output (+) to lamps or indicator switch
30b	Flasher input (+) from hazard switch
31	Ground (-)
C/C1/CP/P	Vehicle pilot lamp output (+)
C2	1st trailer pilot lamp output (+)
C3	2nd trailer pilot lamp output (+)

Part No.	Description
961553151	2 Pin Flasher Unit - 12 V (Single)
961553157	2 Pin Flasher Unit - 12 V (Bulk 50 Pieces)

High capacity flasher with 6 bulb maximum.
 Suitable for hazard warning applications.
 Max Load: 12 lamps / 25 Amps (Hazard)
 Bracket: H84677001

Flasher 3 Terminals

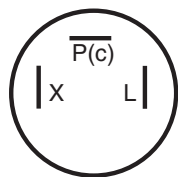

Part No.	Description
961553161	3 Pin Flasher Unit - 12 V (Single)
961553167	3 Pin Flasher Unit - 12 V (Bulk 50 Pieces)

High capacity flasher with 6 bulb maximum.
 Suitable for hazard warning applications.
 Max Load: 12 lamps / 25 Amps (Hazard)
 Bracket: H84677001

961553171	3 Pin Flasher Unit - 24 V (Single)
------------------	------------------------------------

High capacity flasher with 5 bulb maximum.
 Suitable for hazard warning applications.
 Max Load: 10 lamps SAE # 1683 (Hazard)
 Bracket: H84677001

Flasher 3 Terminals

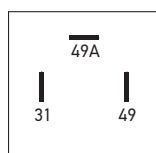

931675911 (H42675031)	3 Pin Flasher Unit - 12 V (Individual)
931675037	3 Pin Flasher Unit - 12 V (Bulk 210 pieces)

High capacity flasher with 8 bulb maximum
 Suitable for hazard warning applications
 Max. Load: 16 Bulbs (Hazard)

ELECTRICS

RELAYS

Product image / Dimensions	Features
----------------------------	----------

Ajustable Control Time Delay Unit

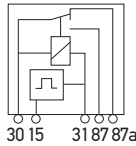
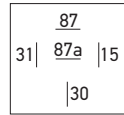

996152131 Adjustable Control Time Delay Unit - Delay on Release - 12 V

996152141 Adjustable Control Time Delay Unit - Delay on Release - 24 V

996152151 Adjustable Control Time Delay Unit - Delay on Operate - 12 V

996152161 Adjustable Control Time Delay Unit - Delay on Operate - 24 V

Designed for a wide range of applications requiring a time delayed switch on or off.

Time Delay Range: 0 to 900 seconds

S1	S2	T(s)
Off	Off	100...900
On	On	14...110
On	Off	2.5...14
Off	On	0...2.5

Relay Socket - Mini ISO

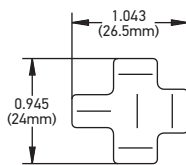

5 terminals, printed circuit board

358112171 (H84989031)	Quantity: 1 piece
358112111 (H84989037)	Quantity: 50 pieces
358112321 (U84989037)	Quantity: 2500 pieces

Relay Socket - Mini ISO

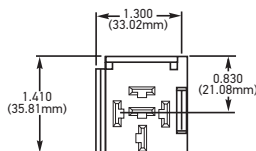

Bracket mount, connector block

358112141 (H84989011)	Quantity: 1 piece
358112131 (H84989017)	Quantity: 50 pieces
358112301 (U84989017)	Quantity: 1000 pieces

Relay Socket - Mini ISO

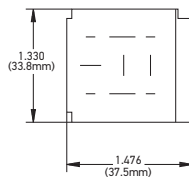

5 or 9 terminals, bracket mount, connector block

003526001	Quantity: 5 pieces
003526002	Quantity: 50 pieces

Relay Socket - 9 pins

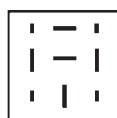



SAE relay socket, 9 pins

Suitable for 2 flat plugs of 6.3 mm, 2 of 9.5 mm and 4 of 2.8 mm.

183161002	Quantity: 5 pieces
------------------	--------------------

ELECTRICS

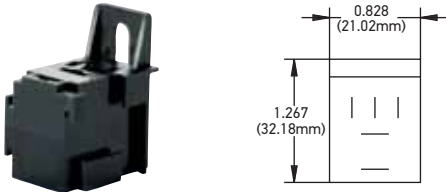
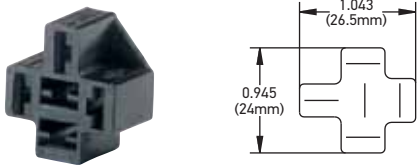
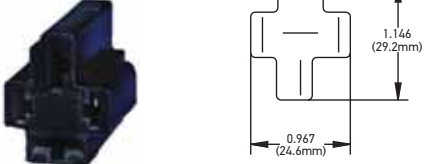
RELAYS ACCESSORIES

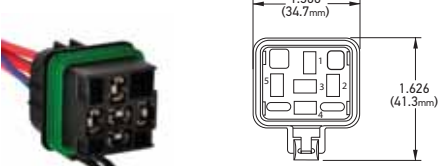
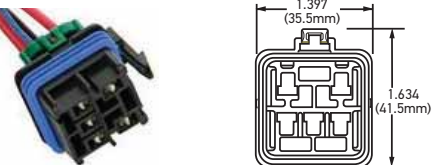
Product image / Dimensions	Part Number	Description						
<p>Relay Socket - Micro ISO</p> 	<p>5 or 9 terminals, bracket mount</p> <table border="1"> <tr> <td>358112161 (H84702001)</td> <td>Quantity: 1 piece</td> </tr> <tr> <td>358112091 (H84702007)</td> <td>Quantity: 50 pieces</td> </tr> <tr> <td>358112241 (U84702007)</td> <td>Quantity: 2250 pieces</td> </tr> </table>	358112161 (H84702001)	Quantity: 1 piece	358112091 (H84702007)	Quantity: 50 pieces	358112241 (U84702007)	Quantity: 2250 pieces	
358112161 (H84702001)	Quantity: 1 piece							
358112091 (H84702007)	Quantity: 50 pieces							
358112241 (U84702007)	Quantity: 2250 pieces							
<p>Relay socket - Mini ISO</p> 	<p>Wire harness connector</p> <table border="1"> <tr> <td>358112181 (H84989021)</td> <td>Quantity: 1 piece</td> </tr> <tr> <td>358112121 (H84989027)</td> <td>Quantity: 50 pieces</td> </tr> <tr> <td>358112311 (U84989027)</td> <td>Quantity: 1000 pieces</td> </tr> </table>	358112181 (H84989021)	Quantity: 1 piece	358112121 (H84989027)	Quantity: 50 pieces	358112311 (U84989027)	Quantity: 1000 pieces	
358112181 (H84989021)	Quantity: 1 piece							
358112121 (H84989027)	Quantity: 50 pieces							
358112311 (U84989027)	Quantity: 1000 pieces							
<p>Relay socket - Mini ISO</p> 	<p>High current (50A), wire harness connector</p> <table border="1"> <tr> <td>358112191 (H84703001)</td> <td>Quantity: 1 piece</td> </tr> <tr> <td>358112151 (H84703007)</td> <td>Quantity: 50 pieces</td> </tr> <tr> <td>358112251 (U84703007)</td> <td>Quantity: 700 pieces</td> </tr> </table>	358112191 (H84703001)	Quantity: 1 piece	358112151 (H84703007)	Quantity: 50 pieces	358112251 (U84703007)	Quantity: 700 pieces	
358112191 (H84703001)	Quantity: 1 piece							
358112151 (H84703007)	Quantity: 50 pieces							
358112251 (U84703007)	Quantity: 700 pieces							
<p>Relay Socket - Mini ISO</p> 	<p>Weatherproof relay connector kit</p> <table border="1"> <tr> <td>358112101 (H84709011)</td> <td>Quantity: 1 piece</td> </tr> </table>	358112101 (H84709011)	Quantity: 1 piece					
358112101 (H84709011)	Quantity: 1 piece							
<p>Relay Socket - Mini ISO</p> 	<p>Weatherproof relay connector with 12" leads</p> <table border="1"> <tr> <td>358114921 (H84709001)</td> <td>Quantity: 1 pieces</td> </tr> </table>	358114921 (H84709001)	Quantity: 1 pieces					
358114921 (H84709001)	Quantity: 1 pieces							
<p>Relay Socket - Mini 280</p> 	<p>Weatherproof relay connector with 12" leads</p> <table border="1"> <tr> <td>358114931 (H84708001)</td> <td>Quantity: 1 pieces</td> </tr> </table>	358114931 (H84708001)	Quantity: 1 pieces					
358114931 (H84708001)	Quantity: 1 pieces							

Product image / Dimensions	Part Number	Description
----------------------------	-------------	-------------

Female Terminals



Female Terminals with Catch

Part No.	AWG wire	Blade size	Package Quantity
172616902 (H84991151)	10 - 12	.375" (9.5mm)	50
172615007	10 - 12	.375" (9.5mm)	2,000
172615902 (H84991141)	6 - 10	.375" (9.5mm)	50
172616007	6 - 10	.375" (9.5mm)	1,800
701235033	14 - 16	.250" (6.3mm)	100
701235034	14 - 16	.250" (6.3mm)	1,500
733815003	18	.188" (4.8mm)	100
744817003	14 - 20	.110" (2.8mm)	100

Relay Box - Mini ISO

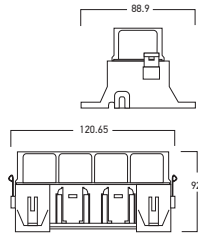

4-Gang Mini ISO Relay Box (Single)

Splashproof relay boxed
Snap-fit clear plastic cover
O-Ring sealed, holds four plug-in type relays
Removable mounting feet
Multiple boxedes can be snapped together

358112221 (H84988001)	Relay Box Mini ISO, 4-gang
358112211 (H84988011)	Relay Box Mini ISO, 7-gang

Fuse Box

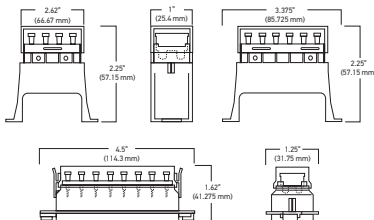

Bottom tap connections

Splashproof fuse boxed
Snap-fit clear plastic cover
O-Ring sealed
Max load: 20a per circuit
Fuses not included

358115881 (H84960061)	Fuse boxed - 4 terminals
358115901 (H84960081)	Fuse boxed - 6 terminals
358115801 (H84960101)	Fuse boxed - 8 terminals

Fuse Box

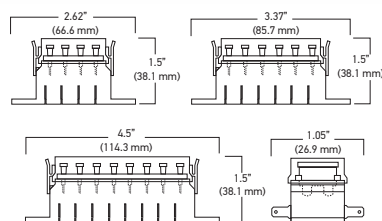

Side connections





Splashproof Fuse Box
Snap-Fit Clear Plastic Cover
O-ring Sealed
Max Load: 20A per circuit
Fuses not included

358115891 (H84960071)	Fuse boxed - 4 terminals, lateral connection
358115781 (H84960091)	Fuse boxed - 6 terminals, lateral connection
358115791 (H84960111)	Fuse boxed - 8 terminals, lateral connection

ELECTRICS





FUSES





Product image / Dimensions	Part Number	Description											
<p>Fuse boxed</p> 	<p>16 Gang fuse boxed - Bottom tab connections</p> <p>Splashproof Fuse Box Snap-Fit Clear Plastic Cover O-ring Sealed Removable Mounting Feet Boxes Can Be Snapped Together for 32,48 Fuses etc. Max Load: 20A per circuit Fuses not included</p>	<table border="1"> <tr> <td>358115871 (H84960051)</td> <td>Fuse Box - 16 terminals, lateral connection</td> </tr> </table>	358115871 (H84960051)	Fuse Box - 16 terminals, lateral connection									
358115871 (H84960051)	Fuse Box - 16 terminals, lateral connection												
<p>Fuse holder MAXI</p>  <p>Fuse not included</p>	<p>Splash proof For MAXI fuses 8 AWG wire 32 cm in length</p>	<table border="1"> <tr> <td>358129911</td> <td>MAXI Fuse holder</td> <td>Quantity: 1 piece</td> </tr> <tr> <td>358129902</td> <td>MAXI Fuse holder</td> <td>Quantity: 5 pieces</td> </tr> </table>	358129911	MAXI Fuse holder	Quantity: 1 piece	358129902	MAXI Fuse holder	Quantity: 5 pieces					
358129911	MAXI Fuse holder	Quantity: 1 piece											
358129902	MAXI Fuse holder	Quantity: 5 pieces											
<p>Fuse holder STANDARD</p> 	<p>Splash proof For STANDARD fuses 12 AWG wire 32 cm in length</p>	<table border="1"> <tr> <td>358129931</td> <td>STANDARD Fuse holder</td> <td>Quantity: 1 piece</td> </tr> <tr> <td>358129921</td> <td>STANDARD Fuse holder</td> <td>Quantity: 10 pieces</td> </tr> </table>	358129931	STANDARD Fuse holder	Quantity: 1 piece	358129921	STANDARD Fuse holder	Quantity: 10 pieces					
358129931	STANDARD Fuse holder	Quantity: 1 piece											
358129921	STANDARD Fuse holder	Quantity: 10 pieces											
<p>MINI Fuse assortment</p> 	<p>Assortment of fast acting fuses. It contains: 20 pieces of each of the following fuses: 5A, 7.5A, 10A, 15A, 20A, 25A, 30A</p> <p>Technical Data</p> <table border="1"> <tr> <td>Voltage Rating</td> <td>58 VCD or less</td> </tr> <tr> <td>Interrupting Rating:</td> <td>1000A @ 58 VCD</td> </tr> <tr> <td>Operating Temperature Range:</td> <td>-40° C a + 125° C</td> </tr> <tr> <td>Complies:</td> <td>SAE J2077 / JASO D612 / ISO 8820-3 / ROHS</td> </tr> </table>	Voltage Rating	58 VCD or less	Interrupting Rating:	1000A @ 58 VCD	Operating Temperature Range:	-40° C a + 125° C	Complies:	SAE J2077 / JASO D612 / ISO 8820-3 / ROHS	<table border="1"> <tr> <td>358129961</td> <td>MINI Fuse assortment</td> <td>Quantity: 140 pieces</td> </tr> </table>	358129961	MINI Fuse assortment	Quantity: 140 pieces
Voltage Rating	58 VCD or less												
Interrupting Rating:	1000A @ 58 VCD												
Operating Temperature Range:	-40° C a + 125° C												
Complies:	SAE J2077 / JASO D612 / ISO 8820-3 / ROHS												
358129961	MINI Fuse assortment	Quantity: 140 pieces											
<p>STANDARD Fuse assortment</p> 	<p>Assortment of fast acting fuses. It contains: 10 pieces of each of the following fuses: 5A, 7.5A, 25A, 30A 20 pieces of each of the following fuses: 10A, 15A, 20A</p> <p>Technical Data</p> <table border="1"> <tr> <td>Voltage Rating</td> <td>58 VCD or less</td> </tr> <tr> <td>Interrupting Rating:</td> <td>1000A @ 58 VCD</td> </tr> <tr> <td>Operating Temperature Range:</td> <td>-40° C a + 125° C</td> </tr> <tr> <td>Complies:</td> <td>SAE J1284 / JASOD612 / ISO 8820-3 / ROHS</td> </tr> </table>	Voltage Rating	58 VCD or less	Interrupting Rating:	1000A @ 58 VCD	Operating Temperature Range:	-40° C a + 125° C	Complies:	SAE J1284 / JASOD612 / ISO 8820-3 / ROHS	<table border="1"> <tr> <td>358129991</td> <td>STANDARD fuse assortment</td> <td>Quantity: 100 pieces</td> </tr> </table>	358129991	STANDARD fuse assortment	Quantity: 100 pieces
Voltage Rating	58 VCD or less												
Interrupting Rating:	1000A @ 58 VCD												
Operating Temperature Range:	-40° C a + 125° C												
Complies:	SAE J1284 / JASOD612 / ISO 8820-3 / ROHS												
358129991	STANDARD fuse assortment	Quantity: 100 pieces											
<p>MAXI Fuse assortment</p> 	<p>Assortment of slow-blow fuses. It contains: 5 pieces of each of the following fuses: 70A, 80A 10 pieces of each of the following fuses: 20A, 30A, 40A, 50A, 60A</p> <p>Technical Data</p> <table border="1"> <tr> <td>Voltage Rating</td> <td>58 VCD or less</td> </tr> <tr> <td>Interrupting Rating:</td> <td>1000A @ 58 VCD</td> </tr> <tr> <td>Operating Temperature Range:</td> <td>-40° C a + 125° C</td> </tr> <tr> <td>Complies:</td> <td>SAE J1888 / JASO D612 / ISO 8820-3 / ROHS</td> </tr> </table>	Voltage Rating	58 VCD or less	Interrupting Rating:	1000A @ 58 VCD	Operating Temperature Range:	-40° C a + 125° C	Complies:	SAE J1888 / JASO D612 / ISO 8820-3 / ROHS	<table border="1"> <tr> <td>358129971</td> <td>MAXI fuse assortment</td> <td>Quantity: 60 pieces</td> </tr> </table>	358129971	MAXI fuse assortment	Quantity: 60 pieces
Voltage Rating	58 VCD or less												
Interrupting Rating:	1000A @ 58 VCD												
Operating Temperature Range:	-40° C a + 125° C												
Complies:	SAE J1888 / JASO D612 / ISO 8820-3 / ROHS												
358129971	MAXI fuse assortment	Quantity: 60 pieces											

Product image / Dimensions	Part Number	Description																																							
MINI LP fuses (low profile)  Fast Acting	Voltage Rating: 58 VCD or less Interrupting Rating: 1000A @ 58 VCD Operating Temperature Range: -40° C a + 125° C Complies: JASO D612 / ISO 8820-9 / ROHS	<table border="1"> <tr><td>358129003</td><td>MINI LP fuse, boxed, 2A: gray</td><td>Quantity: 200 pieces</td></tr> <tr><td>358129013</td><td>MINI LP fuse, boxed, 3A: violet</td><td>Quantity: 200 pieces</td></tr> <tr><td>358129023</td><td>MINI LP fuse, boxed, 4A: pink</td><td>Quantity: 200 pieces</td></tr> <tr><td>358129033</td><td>MINI LP fuse, boxed, 5A: beige</td><td>Quantity: 200 pieces</td></tr> <tr><td>358129043</td><td>MINI LP fuse, boxed, 7.5A: brown</td><td>Quantity: 200 pieces</td></tr> <tr><td>358129053</td><td>MINI LP fuse, boxed, 10A: red</td><td>Quantity: 200 pieces</td></tr> <tr><td>358129063</td><td>MINI LP fuse, boxed, 15A: blue</td><td>Quantity: 200 pieces</td></tr> <tr><td>358129073</td><td>MINI LP fuse, boxed, 20A: yellow</td><td>Quantity: 200 pieces</td></tr> <tr><td>358129083</td><td>MINI LP fuse, boxed, 25A: white</td><td>Quantity: 200 pieces</td></tr> <tr><td>358129093</td><td>MINI LP fuse, boxed, 30A: green</td><td>Quantity: 200 pieces</td></tr> </table>	358129003	MINI LP fuse, boxed, 2A: gray	Quantity: 200 pieces	358129013	MINI LP fuse, boxed, 3A: violet	Quantity: 200 pieces	358129023	MINI LP fuse, boxed, 4A: pink	Quantity: 200 pieces	358129033	MINI LP fuse, boxed, 5A: beige	Quantity: 200 pieces	358129043	MINI LP fuse, boxed, 7.5A: brown	Quantity: 200 pieces	358129053	MINI LP fuse, boxed, 10A: red	Quantity: 200 pieces	358129063	MINI LP fuse, boxed, 15A: blue	Quantity: 200 pieces	358129073	MINI LP fuse, boxed, 20A: yellow	Quantity: 200 pieces	358129083	MINI LP fuse, boxed, 25A: white	Quantity: 200 pieces	358129093	MINI LP fuse, boxed, 30A: green	Quantity: 200 pieces									
358129003	MINI LP fuse, boxed, 2A: gray	Quantity: 200 pieces																																							
358129013	MINI LP fuse, boxed, 3A: violet	Quantity: 200 pieces																																							
358129023	MINI LP fuse, boxed, 4A: pink	Quantity: 200 pieces																																							
358129033	MINI LP fuse, boxed, 5A: beige	Quantity: 200 pieces																																							
358129043	MINI LP fuse, boxed, 7.5A: brown	Quantity: 200 pieces																																							
358129053	MINI LP fuse, boxed, 10A: red	Quantity: 200 pieces																																							
358129063	MINI LP fuse, boxed, 15A: blue	Quantity: 200 pieces																																							
358129073	MINI LP fuse, boxed, 20A: yellow	Quantity: 200 pieces																																							
358129083	MINI LP fuse, boxed, 25A: white	Quantity: 200 pieces																																							
358129093	MINI LP fuse, boxed, 30A: green	Quantity: 200 pieces																																							
MINI fuses  Fast Acting	Technical data: Voltage Rating: 58 VCD or less Interrupting Rating: 1000A @ 58 VCD Operating Temperature Range: -40° C a + 125° C Complies: SAE J2077 / JASO D612 / ISO 8820-3 / ROHS	<table border="1"> <tr><td>358129103</td><td>MINI fuse, boxed, 2A: gray</td><td>Quantity: 200 pieces</td></tr> <tr><td>358129113</td><td>MINI fuse, boxed, 3A: violet</td><td>Quantity: 200 pieces</td></tr> <tr><td>358129123</td><td>MINI fuse, boxed, 4A: pink</td><td>Quantity: 200 pieces</td></tr> <tr><td>358129133</td><td>MINI fuse, boxed, 5A: beige</td><td>Quantity: 200 pieces</td></tr> <tr><td>358129143</td><td>MINI fuse, boxed, 7.5A: brown</td><td>Quantity: 200 pieces</td></tr> <tr><td>358129153</td><td>MINI fuse, boxed, 10A: red</td><td>Quantity: 200 pieces</td></tr> <tr><td>358129163</td><td>MINI fuse, boxed, 15A: blue</td><td>Quantity: 200 pieces</td></tr> <tr><td>358129173</td><td>MINI fuse, boxed, 20A: yellow</td><td>Quantity: 200 pieces</td></tr> <tr><td>358129183</td><td>MINI fuse, boxed, 25A: white</td><td>Quantity: 200 pieces</td></tr> <tr><td>358129193</td><td>MINI fuse, boxed, 30A: green</td><td>Quantity: 200 pieces</td></tr> <tr><td>358129203</td><td>MINI fuse, boxed, 35A: dark green</td><td>Quantity: 200 pieces</td></tr> </table>	358129103	MINI fuse, boxed, 2A: gray	Quantity: 200 pieces	358129113	MINI fuse, boxed, 3A: violet	Quantity: 200 pieces	358129123	MINI fuse, boxed, 4A: pink	Quantity: 200 pieces	358129133	MINI fuse, boxed, 5A: beige	Quantity: 200 pieces	358129143	MINI fuse, boxed, 7.5A: brown	Quantity: 200 pieces	358129153	MINI fuse, boxed, 10A: red	Quantity: 200 pieces	358129163	MINI fuse, boxed, 15A: blue	Quantity: 200 pieces	358129173	MINI fuse, boxed, 20A: yellow	Quantity: 200 pieces	358129183	MINI fuse, boxed, 25A: white	Quantity: 200 pieces	358129193	MINI fuse, boxed, 30A: green	Quantity: 200 pieces	358129203	MINI fuse, boxed, 35A: dark green	Quantity: 200 pieces						
358129103	MINI fuse, boxed, 2A: gray	Quantity: 200 pieces																																							
358129113	MINI fuse, boxed, 3A: violet	Quantity: 200 pieces																																							
358129123	MINI fuse, boxed, 4A: pink	Quantity: 200 pieces																																							
358129133	MINI fuse, boxed, 5A: beige	Quantity: 200 pieces																																							
358129143	MINI fuse, boxed, 7.5A: brown	Quantity: 200 pieces																																							
358129153	MINI fuse, boxed, 10A: red	Quantity: 200 pieces																																							
358129163	MINI fuse, boxed, 15A: blue	Quantity: 200 pieces																																							
358129173	MINI fuse, boxed, 20A: yellow	Quantity: 200 pieces																																							
358129183	MINI fuse, boxed, 25A: white	Quantity: 200 pieces																																							
358129193	MINI fuse, boxed, 30A: green	Quantity: 200 pieces																																							
358129203	MINI fuse, boxed, 35A: dark green	Quantity: 200 pieces																																							
STANDARD fuses  Fast Acting	Technical data: Voltage Rating: 58 VCD or less Interrupting Rating: 1000A @ 58 VCD Operating Temperature Range: -40° C a + 125° C Complies: SAE J1284 / JASOD612 / ISO 8820-3 / ROHS	<table border="1"> <tr><td>358129213</td><td>STANDARD fuse, boxed, 1A: black</td><td>Quantity: 100 pieces</td></tr> <tr><td>358129223</td><td>STANDARD fuse, boxed, 2A: gray</td><td>Quantity: 100 pieces</td></tr> <tr><td>358129233</td><td>STANDARD fuse, boxed, 3A: violet</td><td>Quantity: 100 pieces</td></tr> <tr><td>358129243</td><td>STANDARD fuse, boxed, 4A: pink</td><td>Quantity: 100 pieces</td></tr> <tr><td>358129253</td><td>STANDARD fuse, boxed, 5A: beige</td><td>Quantity: 100 pieces</td></tr> <tr><td>358129263</td><td>STANDARD fuse, boxed, 7.5A: brown</td><td>Quantity: 100 pieces</td></tr> <tr><td>358129273</td><td>STANDARD fuse, boxed, 10A: red</td><td>Quantity: 100 pieces</td></tr> <tr><td>358129283</td><td>STANDARD fuse, boxed, 15A: blue</td><td>Quantity: 100 pieces</td></tr> <tr><td>358129293</td><td>STANDARD fuse, boxed, 20A: yellow</td><td>Quantity: 100 pieces</td></tr> <tr><td>358129303</td><td>STANDARD fuse, boxed, 25A: white</td><td>Quantity: 100 pieces</td></tr> <tr><td>358129313</td><td>STANDARD fuse, boxed, 30A: green</td><td>Quantity: 100 pieces</td></tr> <tr><td>358129323</td><td>STANDARD fuse, boxed, 35A: dark green</td><td>Quantity: 100 pieces</td></tr> <tr><td>358129333</td><td>STANDARD fuse, boxed, 40A: orange</td><td>Quantity: 100 pieces</td></tr> </table>	358129213	STANDARD fuse, boxed, 1A: black	Quantity: 100 pieces	358129223	STANDARD fuse, boxed, 2A: gray	Quantity: 100 pieces	358129233	STANDARD fuse, boxed, 3A: violet	Quantity: 100 pieces	358129243	STANDARD fuse, boxed, 4A: pink	Quantity: 100 pieces	358129253	STANDARD fuse, boxed, 5A: beige	Quantity: 100 pieces	358129263	STANDARD fuse, boxed, 7.5A: brown	Quantity: 100 pieces	358129273	STANDARD fuse, boxed, 10A: red	Quantity: 100 pieces	358129283	STANDARD fuse, boxed, 15A: blue	Quantity: 100 pieces	358129293	STANDARD fuse, boxed, 20A: yellow	Quantity: 100 pieces	358129303	STANDARD fuse, boxed, 25A: white	Quantity: 100 pieces	358129313	STANDARD fuse, boxed, 30A: green	Quantity: 100 pieces	358129323	STANDARD fuse, boxed, 35A: dark green	Quantity: 100 pieces	358129333	STANDARD fuse, boxed, 40A: orange	Quantity: 100 pieces
358129213	STANDARD fuse, boxed, 1A: black	Quantity: 100 pieces																																							
358129223	STANDARD fuse, boxed, 2A: gray	Quantity: 100 pieces																																							
358129233	STANDARD fuse, boxed, 3A: violet	Quantity: 100 pieces																																							
358129243	STANDARD fuse, boxed, 4A: pink	Quantity: 100 pieces																																							
358129253	STANDARD fuse, boxed, 5A: beige	Quantity: 100 pieces																																							
358129263	STANDARD fuse, boxed, 7.5A: brown	Quantity: 100 pieces																																							
358129273	STANDARD fuse, boxed, 10A: red	Quantity: 100 pieces																																							
358129283	STANDARD fuse, boxed, 15A: blue	Quantity: 100 pieces																																							
358129293	STANDARD fuse, boxed, 20A: yellow	Quantity: 100 pieces																																							
358129303	STANDARD fuse, boxed, 25A: white	Quantity: 100 pieces																																							
358129313	STANDARD fuse, boxed, 30A: green	Quantity: 100 pieces																																							
358129323	STANDARD fuse, boxed, 35A: dark green	Quantity: 100 pieces																																							
358129333	STANDARD fuse, boxed, 40A: orange	Quantity: 100 pieces																																							
MAXI fuses  Slow-blow	Technical data: Voltage Rating: 58 VCD or less Interrupting Rating: 1000A @ 58 VCD Operating Temperature Range: -40° C a + 125° C Complies: SAE J1888 / JASO D612 / ISO 8820-3 / ROHS	<table border="1"> <tr><td>358129343</td><td>MAXI fuse, boxed, 20A: yellow</td><td>Quantity: 20 pieces</td></tr> <tr><td>358129353</td><td>MAXI fuse, boxed, 30A: green</td><td>Quantity: 20 pieces</td></tr> <tr><td>358129363</td><td>MAXI fuse, boxed, 40A: orange</td><td>Quantity: 20 pieces</td></tr> <tr><td>358129373</td><td>MAXI fuse, boxed, 50A: red</td><td>Quantity: 20 pieces</td></tr> <tr><td>358129383</td><td>MAXI fuse, boxed, 60A: blue</td><td>Quantity: 20 pieces</td></tr> <tr><td>358129393</td><td>MAXI fuse, boxed, 70A: brown</td><td>Quantity: 20 pieces</td></tr> <tr><td>358129403</td><td>MAXI fuse, boxed, 80A: white</td><td>Quantity: 20 pieces</td></tr> </table>	358129343	MAXI fuse, boxed, 20A: yellow	Quantity: 20 pieces	358129353	MAXI fuse, boxed, 30A: green	Quantity: 20 pieces	358129363	MAXI fuse, boxed, 40A: orange	Quantity: 20 pieces	358129373	MAXI fuse, boxed, 50A: red	Quantity: 20 pieces	358129383	MAXI fuse, boxed, 60A: blue	Quantity: 20 pieces	358129393	MAXI fuse, boxed, 70A: brown	Quantity: 20 pieces	358129403	MAXI fuse, boxed, 80A: white	Quantity: 20 pieces																		
358129343	MAXI fuse, boxed, 20A: yellow	Quantity: 20 pieces																																							
358129353	MAXI fuse, boxed, 30A: green	Quantity: 20 pieces																																							
358129363	MAXI fuse, boxed, 40A: orange	Quantity: 20 pieces																																							
358129373	MAXI fuse, boxed, 50A: red	Quantity: 20 pieces																																							
358129383	MAXI fuse, boxed, 60A: blue	Quantity: 20 pieces																																							
358129393	MAXI fuse, boxed, 70A: brown	Quantity: 20 pieces																																							
358129403	MAXI fuse, boxed, 80A: white	Quantity: 20 pieces																																							

ELECTRICS

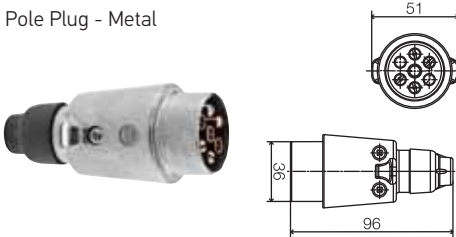
FUSES

Product image / Dimensions	Part Number	Description
MINI LP FUSES Low profile 	358129002	MINI LP fuse, boxed, 2A: gray Quantity: 10 pieces
	358129012	MINI LP fuse, boxed, 3A: violet Quantity: 10 pieces
	358129022	MINI LP fuse, boxed, 4A: pink Quantity: 10 pieces
	358129032	MINI LP fuse, boxed, 5A: beige Quantity: 10 pieces
	358129042	MINI LP fuse, boxed, 7.5A: brown Quantity: 10 pieces
	358129052	MINI LP fuse, boxed, 10A: red Quantity: 10 pieces
	358129062	MINI LP fuse, boxed, 15A: blue Quantity: 10 pieces
	358129072	MINI LP fuse, boxed, 20A: yellow Quantity: 10 pieces
	358129082	MINI LP fuse, boxed, 25A: white Quantity: 10 pieces
	358129092	MINI LP fuse, boxed, 30A: green Quantity: 10 pieces
358129941	Assortment of fuses, includes: 1 piece of each fuse: 5A, 7.5A, 25A, 30A 2 pieces of each fuse: 10A, 15A, 20A Quantity: 10 pieces	
MINI FUSES 	358129102	MINI fuse, boxed, 2A: gray Quantity: 10 pieces
	358129112	MINI fuse, boxed, 3A: violet Quantity: 10 pieces
	358129122	MINI fuse, boxed, 4A: pink Quantity: 10 pieces
	358129132	MINI fuse, boxed, 5A: beige Quantity: 10 pieces
	358129142	MINI fuse, boxed, 7.5A: brown Quantity: 10 pieces
	358129152	MINI fuse, boxed, 10A: red Quantity: 10 pieces
	358129162	MINI fuse, boxed, 15A: blue Quantity: 10 pieces
	358129172	MINI fuse, boxed, 20A: yellow Quantity: 10 pieces
	358129182	MINI fuse, boxed, 25A: white Quantity: 10 pieces
	358129192	MINI fuse, boxed, 30A: green Quantity: 10 pieces
358129202	MINI fuse, boxed, 35A: dark green Quantity: 10 pieces	
358129951	Assortment of fuses, includes: 1 piece of each fuse: 5A, 7.5A, 25A, 30A 2 pieces of each fuse: 10A, 15A, 20A Quantity: 10 pieces	
STANDARD FUSES 	358129212	STANDARD fuse, boxed, 1A: black Quantity: 10 pieces
	358129222	STANDARD fuse, boxed, 2A: gray Quantity: 10 pieces
	358129232	STANDARD fuse, boxed, 3A: violet Quantity: 10 pieces
	358129242	STANDARD fuse, boxed, 4A: pink Quantity: 10 pieces
	358129252	STANDARD fuse, boxed, 5A: beige Quantity: 10 pieces
	358129262	STANDARD fuse, boxed, 7.5A: brown Quantity: 10 pieces
	358129272	STANDARD fuse, boxed, 10A: red Quantity: 10 pieces
	358129282	STANDARD fuse, boxed, 15A: blue Quantity: 10 pieces
	358129292	STANDARD fuse, boxed, 20A: yellow Quantity: 10 pieces
	358129302	STANDARD fuse, boxed, 25A: white Quantity: 10 pieces
358129312	STANDARD fuse, boxed, 30A: green Quantity: 10 pieces	
358129322	STANDARD fuse, boxed, 35A: dark green Quantity: 10 pieces	
358129332	STANDARD fuse, boxed, 40A: orange Quantity: 10 pieces	
358129981	Assortment of fuses, includes: 1 piece of each fuse: 5A, 7.5A, 25A, 30A 2 pieces of each fuse: 10A, 15A, 20A Quantity: 10 pieces	
MAXI FUSES 	358129341	MAXI fuse, boxed 20A: yellow Quantity: 1 piece
	358129351	MAXI fuse, boxed 30A: green Quantity: 1 piece
	358129361	MAXI fuse, boxed 40A: orange Quantity: 1 piece
	358129371	MAXI fuse, boxed 50A: red Quantity: 1 piece
	358129381	MAXI fuse, boxed 60A: blue Quantity: 1 piece
	358129391	MAXI fuse, boxed 70A: brown Quantity: 1 piece
358129401	MAXI fuse, boxed 80A: white Quantity: 1 piece	

Product image / Dimensions	Part Number	Description
<p>Pole Plug - Metal</p> 	001918002	<p>With strain relief and grommet.</p> <p>7-pin plug with screw connections Quantity: 25 pieces</p>
<p>Pole Plug - Plastic</p> 	001930003	<p>With strain relief and grommet.</p> <p>7-pin plug with screw connections Quantity: 25 pieces</p>
<p>Pole Socket - Metal</p> 	001941002	<p>Metal socket with lid Removable contact set. Thermal stability: -25 °C a +70 °C.</p> <p>7-pole plug socket with screw connections Quantity: 25 pieces</p>
<p>Pole Socket - Plastic</p> 	001943003	<p>Plastic socket with lid Removable contact set. Thermal stability: -25 °C a +70 °C.</p> <p>7-pole plug socket with screw connections Quantity: 25 pieces</p>

7-pole plug system / 12 V (compliant with ISO 1724) Pin-out – trailer plug fitting 12 V / 7-pole N type ISO 1724

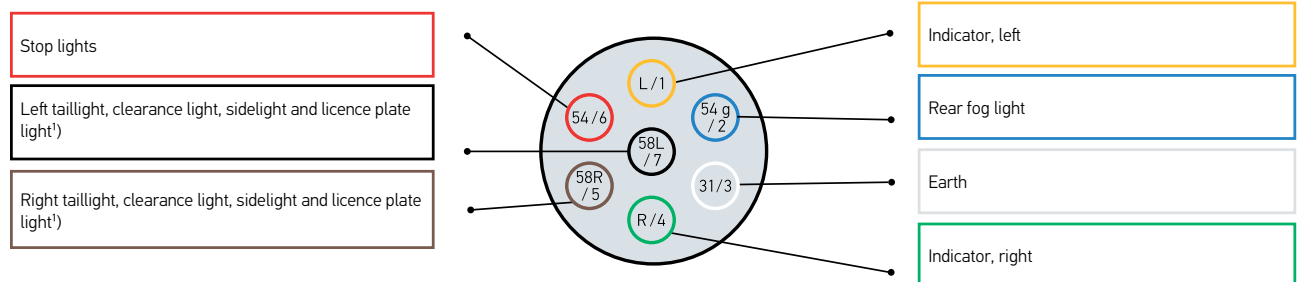

Contact assignment for normal plug-type connectors compliant with ISO 1724, 12 V, 7-pole N

Contact no.	Function	Cable cross-section	Colour of wire insulation
1/L	Indicator, left	1.5 mm ²	Yellow
2/54g	Rear fog light	1.5 mm ²	Blue
3/31	Earth	2.5 mm ²	White
4/R	Indicator, right	1.5 mm ²	Green
5/58R	Right taillight, clearance light, sidelight and licence plate lights ¹⁾	1.5 mm ²	Brown
6/54	Stop lights	1.5 mm ²	Red
7/58L	Left taillight, clearance light, sidelight and licence plate lights ¹⁾	1.5 mm ²	Black

¹⁾ The licence plate lights must be connected in such a way that none of the lamps is connected to both contacts 5 and 7.

EXPERTISE IN ELECTRONICS FOR ORIGINAL EQUIPMENT

Wherever products have to be controlled, measured, regulated or monitored, HELLA components have been tested a million times, under extreme conditions. We work based on the needs of customers and produce the highest quality electronic components for agricultural vehicles, construction machinery, trucks, trailers, city buses, municipal vehicles and vehicles with special bodies, emergency vehicles, campers, motorcycles and cars sports.

We offer a wide range of electronic components in the three fields: in energy management, powertrain and other engine components, which must meet the most demanding operating demands in commercial and passenger vehicles.

HELLA electronic components for all vehicles, operate 24 hours under extremely difficult conditions, ensuring optimal and reliable performance.

The full range of HELLA Electronics

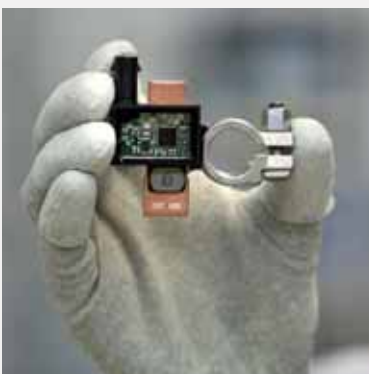

HELLA SENSORS: Up to 30% of the value of a new equipped car is due to its electrical system and, even more, to its electronic systems. That is not a matter of fashion, but the result of consumer demand to increase safety, convenience, information and entertainment while driving. However, any component installed in a car may one day fail. 52% of all failures are already caused by defective software or defective electronics.

HELLA sensors perform complex operations with components such as: speed sensors, flow meters, detonation sensors, manifold pressure / pressure sensors, coolant / oil / air temperature sensors, oxygen sensors (lambda), oil level sensors / coolant, throttle position and throttle valve position - among other components, ensuring optimal operation, at all times.



HELLA ELECTRONICS VEHICLE SPECIFIC APPLICATIONS



For HELLA Electronic vehicle specific applications products, consult our website for detailed information:4

www.partcat.com/hella

Indispensable tool for todays online web search.

ELECTRONICS

ELECTRONICS SENSORS AND COMPONENTS

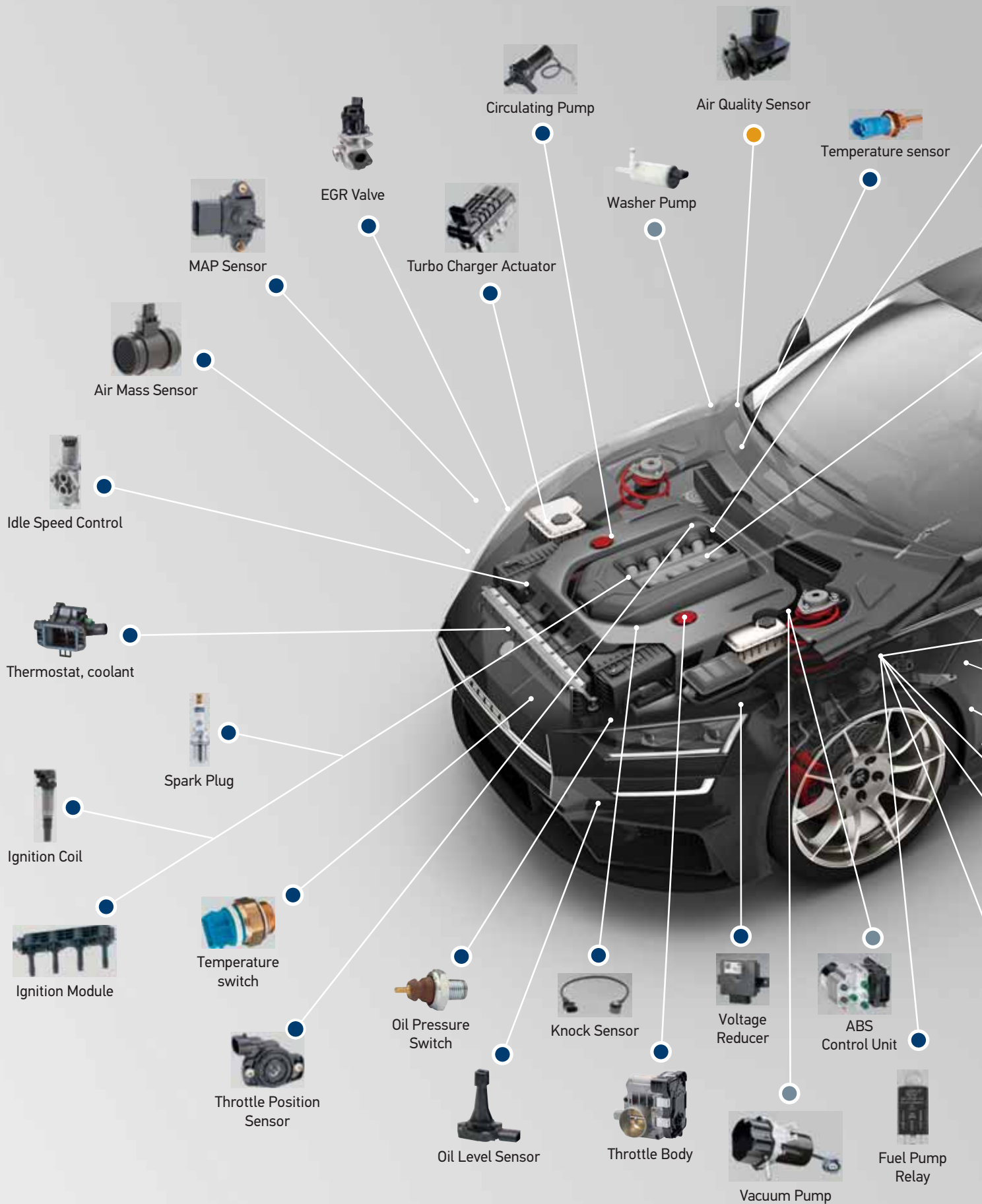





Extremely reliable due to its robust design



PEDAL SENSORS

The pedal sensors transmit the driver's intention to the engine management system. With the principle of wear-free measurement of HELLA CIPOS® sensors and their low mechanical wear, they are ideal for driver's cabins in agricultural vehicles and construction machinery. They are available as suspended or floor mounted versions.

- Accurate position measurement with HELLA technology CIPOS® ($\pm 2\%$ accuracy) or a potentiometer
- Extensive application experience thanks to the production experience acquired since 1996
- Mechanical design variations according to the customer specifications

VACUUM PUMPS

Until recently, most brake superchargers used the vacuum generated by the air intake section of the internal combustion engine. However, with the introduction of new engine technologies (for example, hybrid vehicles, size reduction) or under specific operating conditions (for example, during the cold start / warm-up phase, driving at extreme altitudes or when using the system of air conditioning), the vacuum produced by the engine is no longer enough. Electric vacuum pumps are used to ensure reliable operation of the brake booster

HELLA's electronic product range includes four different types of vacuum pumps for each application. Our portfolio ranges from compact pumps to high performance pumps, depending on the required evacuation power



LEVEL SENSORS

The sensor architecture of the PULS (Packed Ultrasonic Level Sensor) oil level sensor consists of one single multi-chip module that integrates the ultrasonic sensor, the temperature sensor and an ASIC (Application Specific Integrated Circuit). The compactness of our sensors increases their impact and vibration resistance compared with sensors that are fitted with numerous electronic components. The ultrasonic sensor integrated in the multi-chip module transmits a signal that is reflected by the bounding surface between the motor oil and the air.

The signal's running time is measured and the filling level is calculated depending on the speed of sound in the medium. The attenuation cup attached above the multi-chip module serves to calm the medium (particularly) in the dynamic measuring range. The damping cap has openings at the base and at the tip, which allow permanent oil flow

Drive Train



INTELLIGENT BATTERY SENSORS

The intelligent battery sensor (IBS) from HELLA is the key element of vehicle energy management. The IBS reliably and accurately measures the battery parameters: voltage, current and temperature. Information about the battery's state of charge (SOC), state of battery health (SOH) and state of function (SOF) is calculated algorithmically from the measurements. The IBS is designed for use in starter, gel and AGM batteries to monitor in-vehicle starter or consumer batteries. The IBS can be directly integrated into the vehicle's electrical system with the standardised LIN protocol.

- Accurate measurement of voltage, current and temperature battery parameters
- Determining the battery condition parameters State of Charge (SOC), State of Battery Health (SOH) and State of Function (SOF)
- Simple electrical and mechanical integration

Energy Management



ABS CONTROL UNIT

- Analysis of the speed of all four wheels
- Electronic regulation of the braking force on each individual wheel → maximum possible brakeforce
- Self-diagnostic capability of the device: When the ignition is turned on, the system performs a self-test



RADAR - HELLA OE PRODUCT

- First 24 GHz radar for rear end applications on the market
- Up to five functions possible:
 - Blind spot monitoring, lane change assistant, rear pre-crash system, rear cross traffic alert and vehicle exit assistant
- HELLA - the first supplier of radar sensor systems on the independent aftermarket



LED LIGHT CONTROL UNIT

HELLA offers two different types of LED light control units designed to monitor lighting functions.

- Basic version: This only monitors the direction indicator
- Premium Version: This monitors all lighting functions

Only one control unit is required for the left and the right side.

- The DEUTSCH connector, itself integrated in the housing, enables easy integration in the vehicle architecture
- Active thermal management, including overheating protection, for a long service life
- Completely watertight and dust-proof for maximum functioning safety
- Electromagnetic compatibility (EMC) for trouble-free use of, for example, radio



RAIN/LIGHT SENSORS

The full range of functions of the rain-light sensor (five functions: rain sensor, light sensor, solar sensor, humidity measurement, and head-up display) can only be used for passenger vehicle applications. This sensor can only be used to a limited extent in vehicles with special windshields (thick, slanted, transmission).

The optics of the second sensor are specially designed for vehicles with steep windshields and combines the rain and light recognition functions (environment and tunnel recognition).

- Fourth generation of the long-established rain sensors by HELLA
- Five functions in one product: rain, light solar and humidity measurement and adjustment of the light intensity of the head-up display
- Optimised design – extremely compact package space



PAGID

BRAKE SYSTEMS



BRAKEGUIDE

EASILY FIND SUITABLE PRODUCTS



www.partcat.com/hella



HELLA PAGID BRAKE SYSTEMS

Over stretches of gravel, on desert sand and through waterlogged ditches, HELLA PAGID products deliver on the promises we make for them. Before they are supplied to wholesalers and garages, all the brake linings are thoroughly tested in our own research and development center. Only this allows us to achieve our aim of perfection and meet our customers' requirement for outstanding quality. We design our tests in line with the vehicle manufacturers' regulations and to comply with standards and requirement specifications which offer optimum safety and comfort.

For example, our brake linings will have undergone testing over 180,000 miles and 1,000 hours before the final quality check. They are not approved for series production until all the quality and safety criteria have been met.

Powerful, tested and reliable – you can be certain of the quality of all our products.

Products for passenger cars and light commercial vehicles



BRAKE PADS



Hella Pagid is a leading supplier of innovative brake systems in the independent aftermarket. While supporting ASE we also have ASE brake specialists on staff. We can look back on decades of experience as an OEM and offer the sales competence of one of the largest trading organizations in the world. We combine proven OEM engineered brake technology with extensive professional sales support, leading innovation with first-class technical service and a complete product range with outstanding logistics. Hella Pagid brake pads are designed to match perfectly with Hella Pagid rotors and wear sensors to deliver maximum performance in terms of safety, comfort and service life.

- Over 100 compounds to assure you receive the right friction for your car
- Pad design and shims are identical to OEM
- OE stopping capability
- Better brake laws compliant
- Consistent brake feel in all operating conditions
- 98% European coverage
- ECR90 certification 100%

BRAKE ROTORS



These advanced, two-piece brake discs feature an aluminum hat and a High Carbon friction ring, which are bonded together by rivets. The use of aluminum delivers a weight savings of 15-20 percent and reduces the unsprung mass of the brake system. The resulting assembly not only improves driving properties, but also helps contribute to a reduction of fuel consumption.

Hella Pagid composite brake rotors are designed to match perfectly with Hella Pagid Brake System brake pads and wear sensors to deliver maximum performance in terms of safety, comfort and service life. Every Hella Pagid composite brake rotor is manufactured in accordance with strict OE tolerances

- Manufactured in Europe
- Improvement in driving properties
- High Carbon friction ring
- Reduction of fuel consumption
- Full range of BMW applications
- Less prone to warpage
- Quieter operation
- Easy installation
- Keeps rotors looking great for miles
- No cleaning required
- OE design



WEAR SENSORS BRAKE CALIPERS



LIGHT VEHICLES AND COMMERCIAL RANGE



Hella Pagid's new wear sensor range is produced 100% in Europe. Each wear sensor is meticulously produced with injection molding processes to withstand the most harsh conditions.

HellaPagid wear sensors are designed to match perfectly with Hella Pagid brake pads to deliver maximum performance in terms of safety, comfort and service life.

- Injection Molded for durability and quality
- Excellent thermal insulation
- Highly resistant to heat
- 100% made in Europe
- OE manufacturer
- 130+ wear sensors
- 90% European coverage

Hella Pagid Brake calipers: When it comes to brake calipers, we live up to these expectations by currently offering a line of over 112 core-free new parts and 1,400 remanufactured brake calipers with one, two and four-piston arrangements. All components receive anti-corrosion protection and, if required, are supplied with the required accessories (plug and play).

- All products undergo a 100% final inspection after production is complete
- Core-free new parts: Easy handling thanks to dispensing with core deposit processing, No capital tied up with core deposits, more warehouse capacities.
- Premium accessory kit for core-free brake calipers

The Hella Pagid Light Commercial range has been designed to leverage OE Brake competence with unique market experience to provide the best possible brake combination for your customers light commercial vehicles. Starting with increased stopping power from European produced pads and finishing off with High Carbon rotors to dissipate heat to allow optimum braking and increased longevity.

- European stopping power for light commercial applications due to high weight and an LCV's top-speed of ~105-110 miles on the German "Autobahn"
- High Carbon Rotors Designed to absorb and dissipate heat more effectively than iron rotors
- European Wear Sensor Program
- Heavy Duty Police and Taxi Pads
- OE quality



DIGITAL SERVICES

This section is devoted to helping visitors navigate to the correct sites according to the individual needs of original equipment, distributors, dealers and professional workshops.

PORTALS

Web site + PDF's www.hellausa.com

MICROSITES

Auxiliary Lights, signal lighting, bulbs, horns, wiper blades, light bars and accessories www.myhellalights.com

Work lights, relays, warning lights, etc. www.hellahd.com

90 mm Headlights configurator www.hella.com/90mm-modules

Agriculture www.hella.com/agro

Buses www.hella.com/bus

Shapeline configurator www.hella.com/shapeline

ONLINE CATALOGS

Universal parts catalog www.hella.com/upc

Vehicles specific parts www.partcat.com/hella

Brake Systems www.brakeguide.com

TECHNICAL INFORMATION

HELLA TECH WORLD www.hella.com/techworld

APPS FOR SMARTPHONES AND TABLETS

www.hella.com/apps



Horns



Auxiliary Lighting



Work lights



BrakeGuide

SOCIAL MEDIA

Facebook	www.facebook.com/hella.usa
Facebook	www.facebook.com/hellamining
Facebook	www.facebook.com/hellamarine
YouTube	www.youtube.com/myhellalights

APPLICATION DATA

Mapping of information

ACES 3.1

(Aftermarket Catalog Exchange Standard)

PIES

(Product Information Exchange Standard)

Digital Assets

(Images)

Name of Product Line	OPTI CAT	EPICORE	WHI	DCI	SDC
	Code	Code	Code	Code	Code - Under HELLA, Inc.
HELLA Light Bulbs	HELLA BULBS	HES	HLA	Only bulbs and wiper blades	HELLA
HELLA Lighting for Specific Vehicles	HELLA ALL NO BULBS	HES	HLA		HELLA
HELLA Fuel Pumps	HELLA ALL NO BULBS	HEV	HLA		HELLA
HELLA Windshield Wipers	HELLA ALL NO BULBS	HEM	HLA		HELLA
HELLA Electronics	HELLA ALL NO BULBS	HEP	HLA		HELLA
Pierburg	HELLA PIERBURG	PGP	PIG		Pierburg
Behr Thermot-tronik	HELLA BTT	BTT	BEH		BTT
Optilux	HELLA OPTILUX	OPL	HLA	Optilux Lighting	Optilux

GET FREE TECHNICAL TRAINING

HELLA TECH WORLD

Prepare your automobile garage for the future. At HELLA TECH WORLD you will find all our technical expert knowledge in the fields of lighting, electrical, electronic, thermal management, brake systems and vehicle diagnostics. And best of all this content is available 24/7 for you and your customers for FREE!

Register today and start to acquire the knowledge that will give you a real advantage and competitive edge for greater success!

REGISTER TODAY FOR FREE!



Scan this QR code from your Smartphone or Tablet to enter.

Visit:

www.hella.com/techworld

Multiple tools available:



Know-how Tool



Technical Information



HELLA Online Training



Here is a summary of the most important basic terms in lighting technology and the respective units of measure for the evaluation of the properties of bulbs and lights.

Luminous flux Φ

Unit: Lumen [lm]

Luminous flux F is the term used to describe the complete light output radiated from a light source

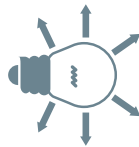

Luminous intensity I

Unit: Candela [cd]

Part of the luminous flux which radiates in a certain direction.



Illuminance E

Unit: Lux [lx]

Illuminance E specifies the ratio of the impinging luminous flux to the illuminated surface. Illuminance is 1 lx when a luminous flux of 1 lm impinges an area of 1 m².

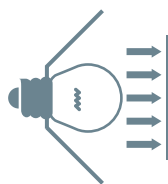

Luminance L

Unit: Candela per square metre [cd/m²]

Luminance L is the impression of brightness the eye has from a luminous or illuminated surface.



Light output η

Unit: Lumen per Watt [lm/W]

Light output η specifies the rate of efficiency with which the consumed electrical power is transformed into light.

Light sources

Light sources are radiators of temperatures which produce light through heat energy. This means the more strongly a light source is heated up, the higher its luminous intensity will be. The low efficiency (8 % light radiation) only allows a relatively low light output in comparison with gas discharge lamps (28 % light radiation). Recently, LEDs have started to be used as light source in front headlights

Colour temperature K

Unit: Kelvin [K]

Kelvin is the unit for colour temperature. The higher the temperature of a light source, the greater the blue share in the colour spectrum and the smaller the red share. A bulb with warm white light has a colour temperature of approx. 2,700 K. In contrast, a gas discharge lamp (D2S) with a colour temperature of 4,250 K produces cold white light which is, however, nearer to the colour of daylight (approx. 5,600 K).

Influence factors on a light source:

Despite the regeneration inside the lamp, the tungsten filament is gradually consumed, which limits its useful life. The durability and luminous efficiency depend strongly, between other factors, of the supply voltage present. The following empirical rule applies: if the supply voltage of a lamp is increased by 5%, the luminous flux increases by 20%, but at the same time the useful life is shortened by half.

Lumen lm:

It is the unit of the International Measurement System to measure the luminous flux, a measure of the light output emitted by the source. The luminous flux differs from the radiant flux in that the first it contemplates the variable sensitivity of the human eye to the different wavelengths of light and the latter involves all the electromagnetic radiation emitted by the light source according to the laws of Wien and Stefan-Boltzmann regardless of whether such radiation is visible or not.

$$1\text{lm} = 1\text{cd} \cdot \text{sr} + 1\text{lx} \cdot \text{m}^2$$

Candela cd:

It is the unit of the International System of Measures to measure light intensity. It is defined as: The light intensity is a given direction, from a source that emits a monochromatic radiation of 540 x 10¹² hertz frequency and of which the intensity radiated in that direction is 1/683 W watts per stereo radian.

Bulbs markings

Vehicle bulbs have to be standardised in compliance with ECE-R37 or R99. This makes bulb replacement possible while at the same time avoiding mix-ups with other bulbs. The following lettering can be found on bulbs:

- Name of the manufacturer
- 6 or 6 V, 12 or 12 V, 24 or 24 V stands for the nominal voltage in compliance with ECE regulation 37.
- H1, H4, H7, P21 W stands for the international category description of ECE-standardised bulbs e.g. 55 W.
- E1 indicates which country the light source has been tested and approved in. "1" stands for Germany.
- "DOT" means that it is also approved for use on the American market.
- "U" stands for UV-reduced bulbs, according to ECE. The bulbs are used in headlights with plastic cover lenses, for example..
- The approval mark granted by the appropriate authorities e.g. E1 (Federal Department of Motor Vehicles in Flensburg) is inscribed on the bulb and is either 37 R (E1) + a five-digit number or only (E1) + a three-digit number (sometimes alphanumeric codes, see illustration).
- Most bulbs have a coded manufacturer's mark. This makes traceability to the manufacturer possible.
- Since not all bulbs have enough room for the markings, the legislator prescribes only the following obligatory information: manufacturer, capacity, test mark and approval mark.

Tips for dealing with light sources

- Xenon headlights require high voltage for ignition, which is why the ballast voltage supply plug should always be removed before any work is carried out on the headlights.
- When replacing bulbs, never touch the new glass bulb since fingerprints will be burnt on and make the bulb opaque.
- If a xenon bulb breaks in a closed room (repair shop) the room should be ventilated to prevent a health hazard due to toxic gases. D3 and D4 xenon lamps do not contain mercury and are therefore more environmentally compatible.
- Standard filament and halogen bulbs do not contain any materials which are problematical from an environmental point of view and can be disposed of with normal household waste.
- In D3 and D4 xenon lamps, the mercury was replaced with non-toxic zinc iodide. These bulbs can be disposed of with normal household waste.

Type approval numbers on the headlight

National and international design and operating regulations apply for the manufacture and testing of vehicle lighting equipment. Special approval marks exist for headlights and can be found on the cover lens or on the housing.

One example

The following can be found on a cover lens HC/R 25 E1 02 A 44457:

- Code HC/R means: H for Halogen-, C for low beam and R for high beam.
- The slash between C and R means that low beam and high-beam cannot be switched on simultaneously (H4 main headlights).
- The subsequent reference number provides information about the luminous intensity of the spotlight.
- The code E1 means that the headlight has been approved in Germany.
- 02 A indicates that there is a clearance light (parking light)
- (A) in the headlight, the regulations for which have been revised twice (02) since publication.
- The five-digit number at the end is the type approval number which is assigned individually for every headlight design approval.

Help in deciphering the combinations of numbers and letters on headlights

ECE regulation 1

- A Clearance light
- B Fog light
- C Low beam
- R High beam
- CR High and low beam
- C/R High or low beam

ECE regulation 8, 20 (H4 only)

- HC Halogen low beam
- HC Halogen high and low beam
- HC/R Halogen high or low beam

ECE regulation 98

- DC Xenon low beam
- DR Xenon high beam
- DC/R Xenon high or low beam

Simultaneous operation is prohibited.

ECE regulation 123

- X Advanced Frontlighting System

WHAT IP PROTECTION CATEGORIES ARE THERE?

Protection category IP 5K4K

Dust may only penetrate to such an extent that function and safety are not impaired. Water that is sprayed from every direction at increased pressure against the housing may not have any damaging effect: water pressure approx. 4 bar.

Protection category IP 5K9K

Dust may only penetrate to such an extent that function and safety are not impaired. Water that is directed from highpressure / steam-jet equipment onto the housing must not have any damaging effect: water pressure approx. 100 bar.

Protection category IP 6K4K

Dust must not penetrate. Water that is sprayed from every direction at increased pressure against the housing must not have any damaging effect: water pressure approx. 4 bar.

Protection class IP 67

Dust must not penetrate. No water may penetrate, even if the device is submersed for some time.

Degree of protection IP 6K9K

Dust must not penetrate. Water that is directed from highpressure / steam-jet equipment onto the housing must not have any damaging effect: water pressure approx. 100 bar

HELLA Automotive Sales, Inc.

201 Kelly Drive
Peachtree City, GA, 30269
Tel.: +1 (877) 224-3552
Fax: +1 (770) 631-7574
www.hellausa.com
www.myhellalights.com

HELLAMEX, S.A. de C.V.

Carretera México Querétaro Km 30,
Bodega 2B y Barranca Honda,
San Martín Obispo, Cuautitlán Izcalli,
Edo. de México. C.P. 54763
Tel. Ventas: +52 (55) 5321-1390
Servicio Técnico: 01 800 221-0471
hellamex@hella.com
www.hellamex.com

HELLA do Brasil Automotive Ltda.

Rua Bom Pastor, 2224 - 15º andar
São Paulo, SP
04203-002 Brasil
Telefone: +55 (11) 2627-7800
info.brasil@hella.com
www.hella-brasil.com

© HELLA GmbH & Co. KGaA. Lippstadt
999142066 07.2020
Printed in USA